

Volume – I

Tender Notification for

**RATE CONTRACT FOR THE PROCUREMENT OF
VARIOUS RATINGS OF MOTORISED RMU WITH
FRTU IN BRPL**

CMC/BR/24-25/RB/PR/RJ/1205

Due Date for Submission of Bids: 28.06.2024

**BSES RAJDHANI POWER LTD (BRPL)
BSES Bhawan, Nehru Place, New Delhi-110019
Corporate Identification Number: U74899DL2001PLC111527
Telephone Number: +91 11 3009 9999
Fax Number: +91 11 2641 9833
Website: www.bsedelhi.com**

Section – I

REQUEST FOR QUOTATION

Tender Notification: CMC/BR/24-25/RB/PR/RJ/1205

**Rate Contract for the Procurement of Various Ratings of
Motorized RMU With FRTU in BRPL**

INDEX

	Page No.
SECTION – I: REQUEST FOR QUOTATION	04
SECTION – II: INSTRUCTIONS TO BIDDER	09
SECTION – III: GENERAL CONDITIONS OF CONTRACT	17-25
1.0 GENERAL INSTRUCTIONS	17
2.0 DEFINITION OF TERMS	18
3.0 CONTRACT DOCUMENTS & PRIORITY	18
4.0 SCOPE OF SUPPLY – GENERAL	19
5.0 QUALITY ASSURANCE AND INSPECTION	19
6.0 PACKING, PACKING LIST & MARKING	20
7.0 PRICE BASIS FOR SUPPLY OF MATERIALS	20
8.0 VARIATION IN TAXES, DUTIES & LEVIES	20
9.0 TAXES & DUTIES ON RAW MATERIALS & BOUGHT OUT COMPONENTS	21
10.0 TERMS OF PAYMENT AND BILLING	21
11.0 PRICE VALIDITY	20
12.0 PERFORMANCE GUARANTEE	21
13.0 FORFEITURE	21
14.0 RELEASE	22
15.0 DEFECTS LIABILITY PERIOD	22
16.0 RETURN, REPLACEMENT OR SUBSTITUTION	22
17.0 EFFECTIVE DATE OF COMMENCEMENT OF CONTRACT	22
18.0 TIME – THE ESSENCE OF CONTRACT	22
19.0 THE LAWS AND JURISDICTION OF CONTRACT	22
20.0 EVENTS OF DEFAULT	22
21.0 CONSEQUENCES OF DEFAULT	23
22.0 PENALTY FOR DELAY	23
23.0 FORCE MAJEURE	23
24.0 TRANSFER AND SUB-LETTING	24
25.0 RECOVERIES	25
26.0 WAIVER	25
27.0 INDEMNIFICATION	25
SECTION – IV: QUANTITY AND DELIVERY REQUIREMENT	26
SECTION – V: TECHNICAL SPECIFICATION OF RING MAIN UNIT	27

SECTION – I: REQUEST FOR QUOTATION

1.0 Event Information

1.01 BRPL invites sealed tenders for supply of Motorised RMU with FRTU from the manufacturers. The bidder must qualify the technical requirements as specified in clause 2.0 stated below. The sealed envelopes shall be duly super scribed as — **“BID FOR RATE CONTRACT FOR THE SUPPLY OF MOTORISED RMU WITH FRTU FOR VARIOUS SITES OF BRPL ,TENDER NOTICE CMC/BR/24-25/RB/PR/RJ/1205 DUE FOR SUBMISSION ON DT. 28.06.2024”**.

Sl. No.	Item Description	Specification	Requirement	Estimated Cost
			Total Qty.	
BRPL, DELHI				
1	Motorised RMU with FRTU for Various Sites in BRPL	SECTION V	787 Nos	95 Cr

Note: Quantity may vary to any extent of +/- 30% of above mentioned total quantity.

1.02 The schedule of specifications with detail terms & conditions can be obtained from address given below against demand draft/Pay Order of **Rs.1180/- with GST-**, drawn in favour of **BSES RAJDHANI POWER LTD**, payable at New Delhi. The sale of tender documents will be issued from **08.06.2024** onwards on all working days upto **22.06.2024**. The tender documents can also be downloaded from the website **“www.bsesdelhi.com”**.

In case tender papers are downloaded from the above website, then the bidder has to enclose a demand draft covering the cost of bid documents as stated above in a separate envelope with suitable superscription —**“Cost of Bid Documents: Tender Notice Ref: CMC/BR/24-25/RB/PR/RJ/1205”**. This envelope should accompany the Bid Documents.

1.03 Offers will be received upto **1000 Hrs. on dt. 28.06.2024** as indicated earlier and will be opened at the address given below dt. **28.06.2024 at 1430 Hrs.** in the presence of authorized representatives of the bidders. The schedule of specifications with detail terms & conditions are enclosed. It is the sole responsibility of the bidder to ensure that the bid documents reach this office on or before the due date.

**HEAD OF THE DEPARTMENT, 1st FLOOR, ‘C’ BLOCK,
CONTRACTS & MATERIALS DEPARTMENT, BSES RAJDHANI POWER LTD,
BSES BHAWAN,
NEHRU PLACE, NEW DELHI-110019.**

1.04 BRPL reserves the right to accept/ reject any or all Tenders without assigning any reason thereof and alter the quantity of materials mentioned in the Tender documents at the time of placing purchase orders. Tender will be summarily rejected if:

- i) Earnest Money Deposit (EMD) @ 1% (One percent) of the Tender value i.e. **Rs.95,00,000/-** is not deposited in shape of Bank Draft in favour of BSES RAJDHANI POWER LTD, payable at New Delhi or Bank Guarantee executed on favour of BSES RAJDHANI POWER LTD.
- ii) The offer does not contain “FOR, NEW DELHI price indicating break-up towards all taxes & duties”.
- iii) Complete Technical details are not enclosed.
- iv) Tender is received after due time due to any reason.

1.05 BRPL reserves the right to reject any or all bids or cancel/ withdraw the invitation for bids without assigning any reason whatsoever and in such case no bidder/ intending bidder shall have any claim arising out of such action time of placing purchase orders.

2.0 Qualification Criteria:-

The prospective bidder must qualify all of the following requirements to be eligible to participate in the bidding. Bidders who meet following requirements will be considered as successful bidder and management has a right to disqualify those bidders who do not meet these requirements.

- 1) The bidder should have own manufacturing facility in India for RMU's since last 3 years.- *Manufacturing and factory incorporation certificate / Undertaking .The details of manufacturing units, locations and works from where supply against this tender shall be proposed to be furnished.*
- 2) The Bidder should have supplied minimum 250 Nos of RMUs (motorized & manual) of similar rating or higher ratings in last 5 years from the date of bid opening to any utilities/SEB's/PSU's/reputed company wherein the end user shall be Utility/SEB's/PSU's.
*i. Summary list of executed Purchase orders, ii. Purchase order copies
iii Material delivery clearance certificate copy or Delivery completion certificates or Invoice Copies*
- 3) Performance certificate for minimum 2 year satisfactory performance for RMU of similar rating or higher ratings supplied in last 7 years from the date of bid opening from at least two utilities/ SEB's/ PSU's/ reputed company wherein the end user shall be utilities/ SEB's/ PSU's. In case of bidder has a previous association with BRPL/BYPL for similar product and service, the performance feedback for that bidder by BRPL/BYPL shall only be considered irrespective of performance certificate issued by any third organization.-
Performance certificates

- 4) The bidder should have servicing, repairing, testing & refurbishment facility in INDIA with necessary spares and testing equipments for providing prompt after sales service for RMU.- *Relevant Details/certificates/Undertaking ,(Details of the set-up available shall be brought out in the offer. the bidder shall also submit undertaking along with the bid confirming the infrastructure details submitted).*
- 5) The bidder should have manufacturing capacity of minimum 30 nos. RMU's per month - *Installed Capacity Certificate.*
- 6) The bidder must possess valid ISO 9001:2015 certification- *Valid copy of Certification*
- 7) Bidder should have Average Annual Sales Turnover of Rs 500 Crores or more in last three (3) Financial Years (i.e., FY 2019-20, 2020-21 & 2021-22). *Balance Sheet / Duly certified CA certificate to be submitted*
- 8) The Bidder shall submit an undertaking that “No Litigation” is pending with the BYPL or its Group/Associates Companies as on date of bid opening.- *Self Undertaking*
- 9) An undertaking (self-certificate) that the bidder has not been blacklisted/debarred by any central/state government institution/Electricity utilities as on date of bid opening- *Self Undertaking*
- 10) The bidder must have valid PAN No., GST Registration Number, in addition to other statutory compliances. The bidder must submit the copy of registrations and submit an undertaking that the bidder shall comply all the statutory compliances as per the laws/rules etc. before the start of the work- *Relevant Statutory Documents Copy/ Self Undertaking*

In case bidder is a 100% owned subsidiary of their parent company then the credentials of the parent organization shall be considered as compliance to the QC requirements. The QC parameters against which the bidder can submit the credential of their parent company are as below:

- 1) The Bidder should have supplied minimum 250 Nos of RMUs (motorized & manual) of similar rating or higher ratings in last 5 years from the date of bid opening to any utilities/SEB's/PSU's/reputed company wherein the end user shall be Utility/SEB's/PSU's.- *i. Summary list of executed Purchase orders ii. Purchase order copies iii Material delivery clearance certificate copy or Delivery completion certificates or Invoice Copies*
- 2) Performance certificate for minimum 2 year satisfactory performance for RMU of similar rating or higher ratings supplied in last 7 years from the date of bid opening from at least two utilities/ SEB's/ PSU's/ reputed company wherein the end user shall be utilities/ SEB's/ PSU's. In case of bidder has a previous association with BRPL/BYPL for similar product and service, the performance feedback for that bidder by BRPL/BYPL shall only be considered irrespective of performance certificate issued by any third organization.- *Performance certificates*

- 3) Bidder should have Average Annual Sales Turnover of Rs 500 Crores or more in last three (3) Financial Years (i.e., FY 2019-20, 2020-21 & 2021-22).- *Balance Sheet / Duly certified CA certificate (Converted to INR) to be submitted*

3.0 Bidding and Award Process

Bidders are requested to submit their questions regarding the RFQ or the bidding process after review of this RFQ. BRPL response to the questions raised by various bidders will be distributed to all participating bidders through website.

a. Time schedule of the bidding process

The bidders on this RFQ package should complete the following within the dates specified as under:

S.No.	Steps	Activity description	Due date
1	Technical Queries	All Queries related to RFQ	On or before 25.06.2024 1500 Hrs.
2	Technical Offer	Documentary evidence in support of qualifying criteria. Technical Literature/ GTP/ Drawings/ Type test report, if any, etc., Testing facilities, any other relevant document, acceptance to commercial terms & conditions viz. delivery Schedule/ Period, Payment terms, PBG etc. Quality assurance plan, Deviation from the specification, list of plant & machinery and testing equipments Unpriced items.	28.06.2024, 1000 Hrs
3	Commercial Offer	Prices for Power Transformer and Break up regarding basic price and taxes. Delivery commitment	28.06.2024, 1000 Hrs
4	Opening of technical bid	As per RFQ	28.06.2024, 1430 Hrs

This is a two part bid process. Bidders are to submit the bids (a) Technical Bid (b) Price Bid. Both these parts should be furnished in separate sealed covers superscribing with specification no., validity etc, with particulars as **Part-I “Technical Particulars & Commercial Terms & Conditions”** and **Part-II “Financial bid“** and these sealed envelopes should again be placed in another sealed cover which shall be submitted before the due date & time specified.

Bidders are requested to submit the bid in one original plus one copy in duplicate.

- **The Part-I (Technical Bid)** - Technical Bid should not contain any cost information whatsoever. In case of Bids where the qualification requirements, technical suitability and

other requirements are found to be inadequate, Part-II “Financial Bid” will be returned unopened.

- **The Part-II (Financial Bid)** - Qualified bidders will be intimated after technical evaluation of all the bids is completed. The date and time of same shall be intimated in due course to the qualified bidders. Notwithstanding anything stated above, the Purchaser reserves the right to assess bidder’s capability to perform the contract, should the circumstances warrant such assessment in the overall interest of the purchaser. In this regard the decision of the purchaser is final.

4.0 Award Decision

Purchaser intends to award the business on a lowest bid basis, so suppliers are encouraged to bid competitively. The decision to place purchase order / letter of acceptance solely depends on purchaser on the cost competitiveness across multiple lots, quality, delivery and bidder’s capacity, in addition to other factors that Purchaser may deem relevant.

The purchaser reserves all the rights to award the contract to one or more bidders so as to meet the delivery requirement or nullify the award decision without any reason.

BSES reserves the right to split the tender quantity amongst techno commercially qualified bidders on account of delivery requirement in tender, quantity under procurement etc.

Splitting of tender quantity amongst more than one bidder shall be governed by below mentioned guidelines:

- If the quantity is to be split among 2 bidders, it will be done in the ratio of 70:30 on L1 price.
- If the quantity is to be split among 3 bidders, it will be done in the ratio of 60:25:15 on L1 price.
- In case quantity needs to be distributed and order splitting is required, distribution of quantity shall be maximum among three (3) bidders.

In the event of your bid being selected by purchaser (and / or its affiliates) and your subsequent DEFAULT on your bid; you will be required to pay purchaser (and / or its affiliates) an amount equal to the difference in your bid and the next lowest bid on the quantity declared in RFQ.

In case any supplier is found unsatisfactory during the delivery process, the award will be cancelled and BRPL reserves the right to award other suppliers who are found fit.

Quantity Variation: The purchaser reserves the rights to vary the quantity by +/- **30%** of the tender quantity.

Repeat Order: BRPL reserves the right to place repeat order at the same rates & terms and conditions as per this tender against additional requirement subject to mutual agreement between BRPL & supplier.

5.0 Market Integrity:

We have a fair and competitive marketplace. The rules for bidders are outlined in the Terms & Conditions. Bidders must agree to these rules prior to participating. In addition to other remedies available, we reserves the right to exclude a bidder from participating in future markets due to the bidder’s violation of any of the rules or obligations contained in the Terms & Condition. Bidders who violate the marketplace rules or engage in behavior that disrupts the fair execution of the marketplace restricts a bidder to length of time, depending upon the seriousness of the violation. Examples of violations include, but are not limited to:

- Failure to honor prices submitted to the marketplace.
- Breach of the terms of the published in Request For Quotation.

6.0 Supplier Confidentiality

All information contained in this RFQ is confidential and may not be disclosed, published or advertised in any manner without written authorization from BRPL. This includes all bidding information submitted.

All RFQ documents remain the property of BRPL and all suppliers are required to return these documents to BRPL upon request.

Suppliers who do not honor these confidentiality provisions will be excluded from participating in future bidding events.

7.0 Contact Information

All communication as regards this RFQ shall be made (i) in English, (ii) in writing and (iii) sent by mail, facsimile to:

	Technical	Commercial
Contact Name	Mr. Vaibhav Vaish Copy to Mr. Amit Tomar	Ms Rachna Jain Copy to Mr. Pankaj Goyal
Address	BSES RAJDHANI POWER LTD, 2nd Floor, B Block, Nehru Place, New Delhi – 110019	C&M Deptt. 1st floor, D- Block, BSES Rajhdhani Power Limited, BSES Bhawan, Nehru Place, New Delhi -110019
Email-ID	vaibhav.vaish@relianceada.com amit.as.tomar@relianceada.com	rachna.jain@relianceada.com pankaj.goyal@relianceada.com

SECTION – II

INSTRUCTION TO BIDDERS (ITB)

**RATE CONTRACT FOR THE SUPPLY OF
MOTORISED RMU WITH FRTU IN BRPL**

CMC/BR/24-25/RB/PR/RJ/1205

A. GENERAL

1.00 BSES Rajdhani power Ltd, hereinafter referred to as the Purchaser are desirous of implementing the various Systems Improvement/Repair & Maintenance works at their respective licensed area in Delhi. The Purchaser has now floated this tender for procurement of RMU as notified earlier in this bid document.

2.00 SCOPE OF WORK

The scope shall include Design, Manufacture, Testing at works conforming to the Technical Specifications enclosed along with Packing, Forwarding, Freight and Unloading and proper stacking at Purchaser's stores.

3.00 DISCLAIMER

3.01 This Document includes statements, which reflect various assumptions, which may or may not be correct. Each Bidder/ Bidding Consortium should conduct its own estimation and analysis and should check the accuracy, reliability and completeness of the information in this Document and obtain independent advice from appropriate sources in their own interest.

3.02 Neither Purchaser nor its employees will have any liability whatsoever to any Bidder or any other person under the law or contract, the principles of restitution or unjust enrichment or otherwise for any loss, expense or damage whatsoever which may arise from or be incurred or suffered in connection with anything contained in this Document, any matter deemed to form part of this Document, provision of Services and any other information supplied by or on behalf of Purchaser or its employees, or otherwise a rising in any way from the selection process for the Supply.

3.03 Though adequate care has been taken while issuing the Bid document, the Bidder should satisfy itself that Documents are complete in all respects. Intimation of any discrepancy shall be given to this office immediately.

3.04 This Document and the information contained herein are Strictly Confidential and are for the use of only the person(s) to whom it is issued. It may not be copied or distributed by the recipient to third parties (other than in confidence to the recipient's professional advisors).

4.00 COST OF BIDDING

The Bidder shall bear all cost associated with the preparation and submission of its Bid and Purchaser will in no case be responsible or liable for those costs.

B BIDDING DOCUMENT**5.00 BIDDING DOCUMENTS**

5.01 The Scope of Work, Bidding Procedures and Contract Terms are described in the Bidding Documents. In addition to the covering letter accompanying Bidding Documents, the Bidding Documents include:

Volume –I

- a) Request for Quotation (RFQ) - Section – I
- b) Instructions to Bidders (ITB) - Section – II
- c) General Conditions of Contract - Section - III
- d) Quantity and delivery requirement - Section –IV
- e) Technical Specifications (TS) - Section –V

Volume – II

- a) Bid Form - Annexure – I
- b) Bid Format - Annexure – II
- c) Price Schedule - Annexure – III
- d) Commercial Terms & Conditions - Annexure - IV
- e) No Deviation Sheet - Annexure - V
- f) Qualification Criterion - Annexure - VI

5.02 The Bidder is expected to examine the Bidding Documents, including all Instructions, Forms, Terms and specifications. Failure to furnish all information required by the Bidding documents or submission of a Bid not substantially responsive to the Bidding Documents in every respect will may result in the rejection of the Bid.

6.00 AMENDMENT OF BIDDING DOCUMENTS

- 6.01 At any time prior to the deadline for submission of Bids, the Purchaser may for any reasons, whether at its own initiative or in response to a clarification requested by a prospective Bidder, modify the Bidding Documents by Amendment.
- 6.02 The Amendment shall be part of the Bidding Documents, pursuant to Clause 5.01, and it will be notified in writing by Fax/e-mail to all the Bidders who have received the Bidding Documents and confirmed their participation to Bid, and will be binding on them.
- 6.03 In order to afford prospective Bidders reasonable time in which to take the Amendment into account in preparing their Bids, the Purchaser may, at its discretion, extend the deadline for the submission of Bids.

C PREPARATION OF BIDS

7.00 LANGUAGE OF BID

The Bid prepared by the Bidder, and all correspondence and documents relating to the Bid exchanged by the Bidder and the Purchaser, shall be written in the English Language. Any printed literature furnished by the Bidder may be written in another Language, provided that this literature is accompanied by an English translation, in which case, for purposes of interpretation of the Bid, the English translation shall govern.

8.00 DOCUMENTS COMPRISING THE BID

The Bid prepared and submitted by the Bidder shall comprise the following components:

- a) Bid Form ,Price & other Schedules (STRICTLY AS PER FORMAT)and Technical Data Sheets completed in accordance with Clause 9.0, 10.0, 11.0 and Technical Specification;
- b) All the Bids must be accompanied with the required EMD as mentioned in the Section-I against each tender.
- c) Power of Attorney or Authorization letter indicating that the person(s) signing the Bid have the authority to sign the Bid and thus that the Bid is binding upon the Bidder during the full period of its validity, in accordance with clause 12.0.

.9.00 BID FORM

9.01 The Bidder shall complete an “Original” and another one “Copy” of the Bid Form and the appropriate Price & Other Schedules and Technical Data Sheets.

9.02 EMD

Pursuant to Clause 8.0(b) above, the bidder shall furnish, as part of its bid, a EMD amounting to 1% of the total bid value (FOR Destination) i.e. Rs. **95,00,000/-**. The EMD is required to protect the Purchaser against the risk of Bidder’s conduct which would warrant the security’s forfeiture.

The EMD shall be denominated in the currency of the bid, and shall be in the following form:

- a) A bank guarantee issued by any scheduled bank strictly as per the form at enclosed and shall be valid for a period of thirty (30) days beyond the validity of the bid.
- b) Bank Draft in favour of BSES RAJDHANI POWER LTD, payable at New Delhi.

Unsuccessful bidders’ EMD will be discharged or returned as promptly as possible as but not later than thirty (30) days after the expiration of the period of bid validity.

The successful bidder’s EMD will be discharged upon furnishing the performance security. The EMD may be forfeited:

- a) If the Bidder:
 - i) Withdraws its bid during the period of bid validity specified by the Bidder in the Bid Form; or
- b) in the case of a successful Bidder, if the Bidder fails:
 - i) to sign the Contract, or
 - ii) to furnish the required performance security.

- 10.01 Bidders shall quote for the entire Scope of Supply with a break-up of prices for individual items. The total Bid Price shall also cover all the Supplier's obligations mentioned in or reasonably to be inferred from the Bidding Documents in respect of Design, Supply, Transportation to site, all in accordance with the requirement of Bidding Documents The Bidder shall complete the appropriate Price Schedules included herein , stating the Unit Price for each item & total Price.
- 10.02 The prices offered shall be inclusive of all costs as well as Duties, Taxes and Levies paid or payable during execution of the supply work, breakup of price constituents, should be there. Prices quoted by the Bidder shall be—Firm “and not subject to any price adjustment during the performance of the Contract. A Bid submitted with an adjustable price quotation will be treated as non -responsive and rejected.

11.00 BID CURRENCIES

Prices shall be quoted in **Indian Rupees (INR) only**.

12.00 PERIOD OF VALIDITY OF BIDS

- 12.01 Bids shall remain valid for **120 days** post bid date.
- 12.02 Notwithstanding Clause12.01 above, the Purchaser may solicit the Bidder's consent to an extension of the Period of Bid Validity. The request and the responses thereto shall be made in writing by Fax/e-mail.

13.00 ALTERNATIVE BIDS

Bidders shall submit Bids, which comply with the Bidding Documents. Alternative Bids will not be considered. The attention of Bidders is drawn to the provisions of Clause 22.03 & 22.04 regarding the rejection of Bids, which are not substantially responsive to the requirements of the Bidding Documents.

14.00 FORMAT AND SIGNING OF BID

- 14.01 The original Bid Form and accompanying documents (as specified in Clause9.0),clearly marked "Original Bid", plus one copy must be received by the Purchaser at the date, time and place specified pursuant to Clauses15.0 and16.0. In the event of any discrepancy between the original and the copies, the original shall govern.
- 14.02 The original and copy of the Bid shall be typed or written in indelible ink and shall be signed by the Bidder or a person or persons duly authorized to sign on behalf of the Bidder. Such authorization shall be indicated by written Power-of-Attorney accompanying the Bid.
- 14.03 The Bid shall contain no interlineations, erasures or overwriting except as necessary to correct errors made by the Bidder, in which case such corrections shall be initialed by the person or persons signing the Bid.

D SUBMISSION OF BIDS

15.0 SEALING AND MARKING OF BIDS

- 15.01 Bid submission: One original & one Copy (hard copies) of all the Bid Documents shall be sealed and submitted to the Purchaser before the closing time for submission of the bid.
- 15.02 The Technical Documents and the EMD shall be enclosed in a sealed envelope and the said envelope shall be superscribed with —**Technical & EMD**. The Financial bid shall be inside another sealed envelope with superscription — **Financial Bid**. Both these envelopes shall be sealed inside another big envelope. All the envelopes should bear the Name and Address of the Bidder and marking for the Original and Copy. The envelopes should be superscribed with —**“Tender Notice No, Due date of submission, Tender opening date”**.
- 15.03 The Bidder has the option of sending the Bids in person. Bids submitted by Telex/ Telegram/ Fax will not be accepted. No request from any Bidder to the Purchaser to collect the proposals from Airlines/Cargo Agents etc shall be entertained by the Purchaser.

16.0 DEADLINE FOR SUBMISSION OF BIDS

- 16.01 The original Bid, together with the required copies, must be received by the Purchaser at the address specified not later than **1500 HRS on 06.01.2023**.
- 16.02 The Purchaser may, at its discretion, extend the deadline for the submission of Bids by amending the Bidding Documents in accordance with Clause 9.0, in which case all rights and obligations of the Purchaser and Bidders previously subject to the deadline will thereafter be subject to the deadline as extended.

17.0 ONE BID PER BIDDER

Each Bidder shall submit only one Bid. A Bidder who submits or participates in more than one Bid will cause all those Bids to be rejected.

18.00 LATE BIDS

Any Bid received by the Purchaser after the deadline for submission of Bids prescribed by the Purchaser, pursuant to Clause 16.0, will be declared "Late" and rejected and returned unopened to the Bidder.

19.00 MODIFICATIONS AND WITHDRAWAL OF BIDS

- 19.01 The Bidder is not allowed to modify or withdraw its Bid after the Bid's submission.

E. EVALUATION OF BID

20.00 PROCESS TO BE CONFIDENTIAL

Information relating to the examination, clarification, evaluation and comparison of Bids and recommendations for the award of a contract shall not be disclosed to Bidders or any other persons not officially concerned with such process. Any effort by a Bidder to influence the Purchaser's processing of Bids or award decisions may result in the rejection of the Bidder's Bid.

21.00 CLARIFICATION OF BIDS

To assist in the examination, evaluation and comparison of Bids, the Purchaser may, at its discretion, ask the bidder for a clarification of its Bid. All responses to requests for clarification shall be in writing and no change in the price or substance of the Bid shall be sought, offered or permitted.

22.00 PRELIMINARY EXAMINATION OF BIDS / RESPONSIVENESS

- 22.01 Purchaser will examine the Bids to determine whether they are complete, whether any computational errors have been made, whether required sureties have been furnished, whether the documents have been properly signed, and whether the Bids are generally in order.
- 22.02 Arithmetical errors will be rectified on the following basis. If there is a discrepancy between the unit price and the total price per item that is obtained by multiplying the unit price and quantity, the unit price shall prevail and the total price per item will be corrected. If there is a discrepancy between the Total Amount and the sum of the total price per item, the sum of the total price per item shall prevail and the Total Amount will be corrected.
- 22.03 Prior to the detailed evaluation, Purchaser will determine the substantial responsiveness of each Bid to the Bidding Documents including production capability and acceptable quality of the Goods offered. A substantially responsive Bid is one, which conforms to all the terms and conditions of the Bidding Documents without material deviation.
- 22.04 Bid determined as not substantially responsive will be rejected by the Purchaser and/or the Purchaser and may not subsequently be made responsive by the Bidder by correction of the non-conformity.

23.0 EVALUATION AND COMPARISON OF BIDS

- 23.01 The evaluation of Bids shall be done based on the delivered cost competitiveness basis.
- 23.02 The evaluation of the Bids shall be a stage-wise procedure. The following stages are identified for evaluation purposes: In the first stage, the Bids would be subjected to a responsiveness check. The Technical Proposals and the Conditional ties of the Bidders would be evaluated. Subsequently, the Financial Proposals along with supplementary Financial Proposals, if any, of Bidders with Techno-commercially Acceptable Bids shall be considered for final evaluation.
- 23.03 The Purchaser's evaluation of a Bid will take into account, in addition to the Bid price, the following factors, in the manner and to the extent indicated in this Clause:

- (a) Supply Schedule
- (b) Deviations from Bidding Documents

Bidders shall base their Bid price on the terms and conditions specified in the Bidding Documents. The cost of all quantifiable deviations and omissions from the specification, terms and conditions specified in Bidding Documents shall be evaluated. The Purchaser will make its own assessment of the cost of any deviation for the purpose of ensuring fair comparison of Bids.

- 23.04 Any adjustment in price, which results from the above procedure, shall be added for the purposes of comparative evaluation only to arrive at an "Evaluated Bid Price". Bid Prices quoted by Bidders shall remain unaltered.

F. AWARD OF CONTRACT

24.0 CONTACTING THE PURCHASER

- 24.01 From the time of Bid submission to the time of contract award, if any Bidder wishes to contact the Purchaser on any matter related to the Bid, it should do so in writing.
- 24.02 Any effort by a Bidder to influence the Purchaser and/or in the Purchaser's decisions in respect of Bid evaluation, Bid comparison or Contract Award, will result in the rejection of the Bidder's Bid.

25.0 THE PURCHASER 'S RIGHT TO ACCEPT ANY BID AND TO REJECT ANY OR ALL BIDS

The Purchaser reserves the right to accept or reject any Bid and to annul the Bidding process and reject all Bids at anytime prior toward of Contract, without thereby incurring any liability to the affected Bidder or Bidders or any obligation to inform the affected Bidder or Bidders of the grounds for the Purchaser's action.

26.0 AWARD OF CONTRACT

The Purchaser will award the Contract to the successful Bidder whose Bid has been Determined to be the lowest-evaluated responsive Bid, provided further that the Bidder has been determined to be qualified to satisfactorily perform the Contract. Purchaser reserves the right to award order other bidders in the tender, provided it is required for progress of project & provided he agrees to come to the lowest rate.

27.0 THE PURCHASER'S RIGHT TO VARY QUANTITIES

The Purchaser reserves the right to vary the quantity i.e. increase or decrease the numbers/quantities without any change in terms and conditions during the execution of the Order.

28.0 LETTER OF INTENT/ NOTIFICATION OF AWARD

The letter of intent/ Notification of Award shall be issued to the successful Bidder whose bids have been considered responsive, techno-commercially acceptable and evaluated to be the lowest (L1). The successful Bidder shall be required to furnish a letter of acceptance within 7 days of issue of the letter of intent /Notification of Award by Purchaser.

29.0 PERFORMANCE BANK GUARANTEE

Bidder shall initially submit the PBG with in 28 days of placement of RC for 1% of RC Value (including GST) valid till RC validity period plus three month claim period. If there is extension in RC validity date, the BG shall be extended accordingly .

Upon submission of the performance security, the EMD shall be released.

Thereafter bidder shall submit PBG on Purchase Order (PO) basis for 10% of the PO value (including GST).The Performance Bond shall be valid for a period of twenty four months (24) from the date of the commissioning or thirty months (30) from the date of receipt of material (last consignment of PO) at site/stores whichever is earlier plus 3 months towards claim period.

30.00 CORRUPT OR FRADULENT PRACTICES

30.01 The Purchaser requires that the Bidders observe the highest standard of ethics during the procurement and execution of the Project. In pursuance of this policy, the Purchaser:

- (a) Defines, for the purposes of this provision, the terms set forth below as follows:
 - i) "Corrupt practice" means behavior on the part of officials in the public or private sectors by which they improperly and unlawfully enrich themselves and/or those close to them ,or induce others to do so, by misusing the position in which they are placed, and it includes the offering, giving, receiving, or soliciting of anything of value to influence the action of any such official in the procurement process or in contract execution; and
 - ii) "Fraudulent practice" means a misrepresentation of facts in order to influence a procurement process or the execution of a contract to the detriment of the Purchaser, and includes collusive practice among Bidders (prior to or after Bid submission) designed to establish Bid prices at artificial non-competitive levels and to deprive the Purchaser of the benefits of free and open competition.
- (b) Will reject a proposal forward if it determines that the Bidder recommended for award has engaged in corrupt or fraudulent practices in competing for the contract in question ;
- (c) Will declare a firm ineligible, either indefinitely or for a stated period of time, to be awarded a contract if it at any time determines that the firm has engaged in corrupt or fraudulent practices in competing for, or in executing, a contract.

30.02 Furthermore, Bidders shall be aware of the provision stated in the General Conditions of Contract.

SECTION – III

GENERAL CONDITIONS OF CONTRACT (GCC)

**RATE CONTRACT FOR THE SUPPLY OF VARIOUS
RATINGS OF MOTORISED RMU WITH FRTU IN
BRPL**

CMC/BR/24-25/RB/PR/RJ/1205

GENERAL TERMS AND CONDITIONS

1.0 General Instructions

- 1.01 All the Bids shall be prepared and submitted in accordance with these instructions.
- 1.02 Bidder shall bear all costs associated with the preparation and delivery of its Bid, and the Purchaser will in no case shall be responsible or liable for these costs.
- 1.03 The Bid should be submitted by the Bidder in whose name the bid document has been issued and under no circumstances it shall be transferred/ sold to the other party.
- 1.04 The Purchaser reserves the right to request for any additional information and also reserves the right to reject the proposal of any Bidder, if in the opinion of the Purchaser, the data in support of RFQ requirement is incomplete.
- 1.05 The Bidder is expected to examine all instructions, forms, terms & conditions and specifications in the Bid Documents. Failure to furnish all information required in the Bid Documents or submission of a Bid not substantially responsive to the Bid Documents in every respect may result in rejection of the Bid. However, the Purchaser's decision in regard to the responsiveness and rejection of bids shall be final and binding without any obligation, financial or otherwise, on the Purchaser.

2.0 Definition of Terms

- 2.01 "Purchaser" shall mean BRPL Limited, on whose behalf this bid enquiry is issued by its authorized representative / officers.
- 2.02 "Bidder" shall mean the firm who quotes against this bid enquiry issued by the Purchaser. "Supplier" or "Suppliers" shall mean the successful Bidder and/or Bidders whose bid has been accepted by the Purchaser and on whom the "Letter of Acceptance" is placed by the Purchaser and shall include his heirs, legal representatives, successors and permitted assigns wherever the context so admits.
- 2.03 "Supply" shall mean the Scope of Contract as described.
- 2.04 "Specification" shall mean collectively all the terms and stipulations contained in those portions of this bid document known as RFQ, Commercial Terms & Condition, Instructions to Bidders, Technical Specifications and the Amendments, Revisions, Deletions or Additions, as may be made by the Purchaser from time to time.
- 2.05 "Letter of Acceptance" shall mean the official notice issued by the Purchaser notifying the Supplier that his proposal has been accepted and it shall include amendments thereto, if any, issued by the Purchaser. The "Letter of Acceptance" issued by the Purchaser shall be binding on the "Supplier" The date of Letter of Acceptance shall be taken as the effective date of the commencement of contract.

- 2.06 “Month” shall mean the calendar month and “Day” shall mean the calendar day.
- 2.07 “Codes and Standards” shall mean all the applicable codes and standards as indicated in the Specification.
- 2.08 “Offer Sheet” shall mean Bidder's firm offer submitted to BRPL in accordance with the specification.
- 2.09 “Contract” shall mean the “Letter of Acceptance” issued by the Purchaser.
- 2.10 “Contract Price” shall mean the price referred to in the “Letter of Acceptance”.
- 2.11 “Contract Period” shall mean the period during which the “Contract” shall be executed as agreed between the Supplier and the Purchaser in the Contract inclusive of extended contract period for reason beyond the control of the Supplier and/or Purchaser due to force majeure.
- 2.12 “Acceptance” shall mean and deemed to include one or more of the following as will be stipulated in the specification:
- a) The written acceptance of material by the inspector at suppliers works to ship the materials.
 - b) Acceptance of material at Purchaser site stores after its receipt and due inspection/ testing and release of material acceptance voucher.
 - c) Where the scope of the contract includes supply, acceptance shall mean issue of necessary equipment / material takeover receipt after installation & commissioning and final acceptance.

3.0 Contract Documents & Priority

- 3.01 Contract Documents: The terms and conditions of the contract shall consist solely of these RFQ conditions and the offer sheet.
- 3.02 Priority: Should there be any discrepancy between any term hereof and any term of the Offer Sheet, the terms of these RFQ shall prevail.

4.0 Scope of Supply - General

- 4.01 The “Scope of Supply” shall be on the basis of Bidder’s responsibility, completely covering the obligations, responsibility and supplies provided in this Bid enquiry whether implicit or explicit.
- 4.02 Bidder shall have to quote for the Bill of quantities as listed in Section – IV of this RFQ.
- 4.03 Quantity variation and additional requirement if any shall be communicated to successful bidder during project execution.
- 4.04 All relevant drawings, data and instruction manuals.

5.0 Quality Assurance and Inspection

- 5.01 Immediately on award of contract, the bidder shall prepare detailed quality assurance plan / test procedure identifying the various stages of manufacture, quality checks performed at each stage, raw material inspection and the Customer hold points. The document shall also furnish details of method of checking, inspection and acceptance standards / values and get the approval of Purchaser before proceeding with manufacturing. However, Purchaser shall have right to review the inspection reports, quality checks and results of suppliers in house inspection department which are not Customer hold points and the supplier shall comply with the remarks made by purchaser or his representative on such reviews with regards to further testing, rectification or rejection, etc.
- 5.02 Witness and Hold points are critical steps in manufacturing, inspection and testing where the supplier is obliged to notify the Purchaser in advance so that it may be witnessed by the Purchaser. Final inspection is a mandatory hold point. The supplier needs to proceed with the work past a hold point only after clearance by purchaser or a witness waiver letter from BRPL.
- 5.03 The performance of waiver of QA activity by Purchaser at any stage of manufacturing does not relieve the supplier of any obligation to perform in accordance with and meet all the requirements of the procurement documents and also all the codes & reference documents mentioned in the procurement document nor shall it preclude subsequent rejection by the purchaser.
- 5.04 On completion of manufacturing the items can be dispatched only after issue of shipping release by the Purchaser.
- 5.05 All testing and inspection shall be done without any extra cost.
- 5.06 Purchaser reserve the right to send any material out of the supply to any recognized laboratory for testing and the cost of testing shall be borne by the Purchaser. In case the material is found not in order with the technical requirement / specification, the charges along with any other penalty which may be levied is to be borne by the bidder. To avoid any complaint the supplier is advised to send his representative to the stores to see that the material sent for testing is being sealed in the presence of bidders representative.
- 5.07 Bidder has to sign quality agreement before supply of the material.

6.0 Packing, Packing List & Marking

- 6.01 Packing: Supplier shall pack or shall cause to be packed all Commodities in boxes and containers and otherwise in such a manner as shall be reasonably suitable for shipment by road or rail to BRPL without undue risk of damage in transit.
- 6.02 Packing List: The contents of each package shall be itemized on a detailed list showing the exact weight and the extreme outside dimensions (length, width and eight) of each container or box. One copy of the packing list shall be enclosed in each package delivered. There shall

also be enclosed in one package a master packing list identifying each individual package, which is part of the shipment. On any packaging where it is not feasible to place the packing list inside the container, all pertinent information shall be stenciled on the outside and will thus constitute a packing list.

7.01 Prices basis for supply of materials

Bidders require quoting their prices on Landed Cost Basis and separate price for each item. For Supply to BRPL Delhi the price shall be inclusive of packing, forwarding, GST and freights. The above supply prices shall also include unloading at site stores. Transit and storage insurance will be arranged by BRPL; however bidder to furnish required details in advance for arranging the same by BRPL.

8.0 Variation in taxes, duties & levies:

- 8.01 The total order value shall be adjusted on account of any variations in Statutory Levies imposed by Competent Authorities by way of fresh notification(s) within the stipulated delivery period only. However, incase of reduction in taxes, duties and levies, the benefits of the same shall be passed on to BUYER.
- 8.02 No other Taxes, Duties & Levies other than those specified above will be payable by BUYER except in case of new Levies, Taxes & Duties imposed by the Competent Authorities by way of fresh notification(s) subsequent to the issue of PURCHASE ORDER but within the stipulated delivery period.
- 8.03 Notwithstanding what is stated above, changes in Taxes, Duties & Levies shall apply only to that portion of PURCHASE ORDER not executed on the date of notification by Competent Authority. Further, changes in Taxes, Duties & Levies after due date of Delivery shall not affect PURCHASE ORDER Terms and Value.
- 8.04 PURCHASE ORDER value shall not be subject to any variation on account of variation in Exchange rate(s).

9.0 Taxes & Duties on raw materials & bought out components:

- 9.01 Taxes & Duties on raw materials & bought out components are included in Order Value and are not subject to any escalation or variation for any reason whatsoever.
- 9.02 Taxes & Duties on raw materials & bought out components procured indigenously are included in Order Value and are not subject to any escalation or variation for any reason whatsoever.

10.0 Terms of payment and billing

10.01 For Supply of Equipments:

- 100% payment shall be made within 45 days from the date of receipt of material at store/ site against submission of 10 % performance bank guarantee. (Refer 10.01)

10.02 Bidder to submit the following documents against dispatch of each consignment:

- i) Consignee copy of LR
- ii) Supplier detailed invoice showing commodity description, quantity, unit price, total price and basis of delivery.
- iii) Original certificate issued by BRPL confirming receipt of material at site and acceptance of the same.
- iv) Dispatch clearance / inspection report in original issued by the inspection authority
- v) Packing List.
- vi) Test Reports
- vii) Guarantee Certificate.
- viii) Insurance policy to be obtained by supplier

11.0 Price Validity

11.01 All bids submitted shall remain valid, firm and subject to unconditional acceptance by BRPL Delhi for 120 days post bid-date. For awarded suppliers, the prices shall remain valid and firm till contract completion.

12.0 Performance Guarantee

12.01 Bidder shall initially submit the PBG with in 28 days of placement of RC for 1% of RC Value (including GST) valid till RC validity period plus three month claim period. If there is extension in RC validity date, the BG shall be extended accordingly .

Upon submission of the performance security, the EMD shall be released..

Thereafter bidder shall submit PBG on Purchase Order (PO) basis for 10% of the PO value (including GST).The Performance Bond shall be valid for a period of twenty four months (24) from the date of the commissioning or thirty months (30) from the date of receipt of material (last consignment of PO) at site/stores whichever is earlier plus 3 months towards claim period. It shall be in accordance with one of the following terms:

- a) Depositing pay order /demand draft of the relevant amount directly with BRPL at the address listed above or as otherwise specified by BRPL, either of which shall constitute the Performance Bond hereunder; or
- b) Bank guarantee from any nationalized bank in favour of BSES RAJDHANI POWER LTD (BRPL). The performance Bank guarantee shall be in the format as specified by BRPL.

13.0 Forfeiture

13.01 Each Performance Bond established under Clause 10.0 shall contain a statement that it shall be automatically and unconditionally forfeited without recourse and payable against the presentation by BRPL of this Performance Bond to the ICICI Bank at Mumbai, or to the relevant company/ correspondent bank referred to above, as the case may be, together with a simple statement that supplier has failed to comply with any term or condition set forth in the Contract.

13.02 Each Performance Bond established under will be automatically and unconditionally forfeited without recourse if BRPL in its sole discretion determines that supplier has failed to comply with any term or condition set forth in the contract.

14.0 Release

All Performance Bonds will be released without interest within seven (7) days from the last date up to which the Performance Bond has to be kept valid (as defined in Clause 10.0) except for the case set forth in Clause 21.0.

15.0 Defects Liability Period

15.01 The bidder to Guarantee the materials / items supplied against any defect of failure, which arise due to faulty materials, workmanship or design for the entire defects liability period. The Defect liability period shall be for 10 years with maintaining resistance less than 5 ohms from the date of commissioning or 6 months from the date of delivery whichever is earlier. If during the defects liability period any materials / items are found to be defective, these shall be replaced or rectified by the bidder at his own cost within 30 days from the date of receipt of intimation.

16.0 Return, Replacement or Substitution.

BRPL shall give Supplier notice of any defective Commodity promptly after becoming aware thereof. BRPL may in its discretion elect to return defective Commodities to Supplier for replacement, free of charge to BRPL, or may reject such Commodities and purchase the same or similar Commodities from any third party. In the latter case BRPL shall furnish proof to Supplier of the cost of such substitute purchase. In either case, all costs of any replacement, substitution, shipping, labour and other related expenses incurred in connection with the return and replacement or for the substitute purchase of a Commodity hereunder should be for the account of Supplier. BRPL may set off such costs against any amounts payable by BRPL to Supplier. Supplier shall reimburse BRPL for the amount, if any, by which the price of a substitute Commodity exceeds the price for such Commodity as quoted in the Bid.

17.0 Effective Date of Commencement of Contract:

17.01 The date of the issue of the Letter of Acceptance shall be treated as the effective date of the commencement of Contract.

18.0 Time – The Essence of Contract

18.01 The time and the date of completion of the “Supply” as stipulated in the Letter Of Acceptance / Purchase order issued to the Supplier shall be deemed to be the essence of the

“Contract”. The Supply has to be completed not later than the aforesaid Schedule and date of completion of supply.

19.0 The Laws and Jurisdiction of Contract:

19.01 The laws applicable to this Contract shall be the Laws in force in India.

19.02 All disputes arising in connection with the present Contract shall be settled amicably by mutual consultation failing which shall be finally settled as per the rules of Arbitration and Conciliation Act, 1996 at the discretion of Purchaser. The venue of arbitration shall be at Mumbai in India

20.0 Events of Default

20.01 Events of Default. Each of the following events or occurrences shall constitute an event of default ("Event of Default") under the Contract:

- a) Supplier fails or refuses to pay any amounts due under the Contract;
- b) Supplier fails or refuses to deliver Commodities conforming to this RFQ/ specifications, or fails to deliver Commodities within the period specified in P.O. or any extension thereof
- c) Supplier becomes insolvent or unable to pay its debts when due, or commits any act of bankruptcy, such as filing any petition in any bankruptcy, winding-up or reorganization proceeding, or acknowledges in writing its insolvency or inability to pay its debts; or the Supplier's creditors file any petition relating to bankruptcy of Supplier;
- d) Supplier otherwise fails or refuses to perform or observe any term or condition of the Contract and such failure is not remediable or, if remediable, continues for a period of 30 days after receipt by the Supplier of notice of such failure from BRPL.

21.0 Consequences of Default.

- a) If an Event of Default shall occur and be continuing, BRPL may forthwith terminate the Contract by written notice.
- b) In the event of an Event of Default, BRPL may, without prejudice to any other right granted to it by law, or the Contract, take any or all of the following actions;
 - i) present for payment to the relevant bank the Performance Bond;
 - ii) purchase the same or similar Commodities from any third party; and/or
 - iii) recover any losses and/or additional expenses BRPL may incur as a result of Supplier's default.

22.0 Penalty for Delay

22.01 If supply of items / equipments is delayed beyond the supply schedule as stipulated in purchase order then the Supplier shall be liable to pay to the Purchaser as penalty for delay, a

sum of 1% (one percent) of the contract price for every week delay or part thereof for undelivered quantities.

22.02 The total amount of penalty for delay under the contract will be subject to a maximum of ten percent (10%) of the contract price for undelivered quantities.

22.03 The Purchaser may, without prejudice to any method of recovery, deduct the amount for such damages from any amount due or which may become due to the Supplier or from the Performance Bond or file a claim against the supplier.

23.0 Force Majeure

23.01 General

An "Event of Force Majeure" shall mean any event or circumstance not within the reasonable control directly or indirectly, of the Party affected, but only if and to the extent that:

- i) Such event or circumstance materially and adversely affects the ability of the affected Party to perform its obligations under this Contract, and the affected Party has taken all reasonable precautions, due care and reasonable alternative measures in order to prevent or avoid the effect of such event on the affected party's ability to perform its obligations under this Contract and to mitigate the consequences thereof.
- ii) For the avoidance of doubt, if such event or circumstance would not have materially and adversely affected the performance of the affected party had such affected party followed good industry practice, such event or circumstance shall not constitute force majeure.
- iii) Such event is not the direct or indirect result of the failure of such Party to perform any of its obligations under this Contract.
- iv) Such Party has given the other Party prompt notice describing such events, the effect thereof and the actions being taken in order to comply with above clause.

23.02 Specific Events of Force Majeure subject to the provisions of above clause, Events of Force Majeure shall include only the following to the extent that they or their consequences satisfy the above requirements:

23.03 Mitigation of Events of Force Majeure Each Party shall:

- i) Make all reasonable efforts to prevent and reduce to a minimum and mitigate the effect of any delay occasioned by an Event of Force Majeure including recourse to alternate methods of satisfying its obligations under the Contract;
- ii) Use its best efforts to ensure resumption of normal performance after the termination of any Event of Force Majeure and shall perform its obligations to the maximum extent practicable as agreed between the Parties; and
- iii) Keep the other Party informed at regular intervals of the circumstances concerning the event of Force Majeure, with best estimates as to its likely continuation and what measures or contingency planning it is taking to mitigate and or terminate the Event of Force Majeure.

- 23.04 Burden of Proof In the event that the Parties are unable in good faith to agree that a Force Majeure event has occurred to an affected party, the parties shall resolve their dispute in accordance with the provisions of this Agreement. The burden of proof as to whether or not a force majeure event has occurred shall be upon the party claiming that the force majeure event has occurred and that it is the affected party.
- 23.05 Termination for Certain Events of Force Majeure. If any obligation of any Party under the Contract is or is reasonably expected to be delayed or prevented by a Force Majeure event for a continuous period of more than 3 months, the Parties shall promptly discuss in good faith how to proceed with a view to reaching a solution on mutually agreed basis. If a solution on mutually agreed basis cannot be arrived at within a period of 30 days after the expiry of the period of three months, the Contract shall be terminated after the said period of 30 days and neither Party shall be liable to the other for any consequences arising on account of such termination.
- 23.06 Limitation of Force Majeure event. The Supplier shall not be relieved of any obligation under the Contract solely because cost of performance is increased, whether as a consequence of adverse economic consequences or otherwise.
- 23.07 Extension of Contract Period due to Force Majeure event The Contract period may be extended by mutual agreement of Parties by way of an adjustment on account of any period during which an obligation of either Party is suspended due to a Force Majeure event.
- 23.08 Effect of Events of Force Majeure. Except as otherwise provided herein or may further be agreed between the Parties, either Party shall be excused from performance and neither Party shall be construed to be in default in respect of any obligations hereunder, for so long as failure to perform such obligations shall be due to and event of Force Majeure."

24.0 Transfer And Sub-Letting

- 24.01 The Supplier shall not sublet, transfer, assign or otherwise part with the Contract or any part thereof, either directly or indirectly, without prior written permission of the Purchaser.

25.0 Recoveries

- 25.01 Whenever under this contract any money is recoverable from and payable by the bidder, the purchaser shall be entitled to recover such sum by appropriating in part or in whole by detecting any sum due to which any time thereafter may become due from the supplier in this or any other contract. Should the sum be not sufficient to cover the full amount recoverable the bidder shall pay to the purchaser on demand the remaining balance.

26.0 Waiver

- 26.01 Failure to enforce any condition herein contained shall not operate as a waiver of the condition itself or any subsequent breach thereof.

27.0 Indemnification

27.01 Notwithstanding contrary to anything contained in this RFQ, Supplier shall at his costs and risks make good any loss or damage to the property of the Purchaser and/or the other Supplier engaged by the Purchaser and/or the employees of the Purchaser and/or employees of the other Supplier engaged by the Purchaser whatsoever arising out of the negligence of the Supplier while performing the obligations under this contract.

SECTION – IV: QUANTITY AND DELIVERY REQUIREMENT

Sl. No.	Item Description	Specification	Requirement	Delivery Schedule	Location
BRPL,DELHI					
1	Supply of Motorised RMU with FRTU	SECTION V	787 Nos	In lots as per PO /BRPL requirement.	Stores BRPL Delhi
TOTAL					

BID FORM

Supply of Various Ratings of Motorized RMU with FRTU

To
Head of the Department Contracts & Materials BSES Rajdhani Power Ltd BSES Bhawan, Nehru
Place New Delhi– 110019
Sir,

We understand that BRPL is desirous of procuring “Motorized RMU with FRTU” in its licensed distribution network area in Delhi. Having examined the Bidding Documents for the above named works, we the undersigned, offer to deliver the goods in full conformity with the Drawings, Conditions of Contract and specifications for the sum of AS PER PRICE BID ENCLOSED or such other sums as may be determined in accordance with the terms and conditions of the contract .The above amounts are in accordance with the Price Schedules attached herewith and are made part of this bid.

If our Bid is accepted, we undertake to deliver the entire goods as per delivery schedule given by you from the date of award of purchase order/letter of intent.

If our Bid is accepted, we will furnish a performance bank guarantee for an amount of 10% (Ten) percent of the total contract value for due performance of the Contract in accordance with the General Conditions of Contract.

We agree to abide by this Bid for a period of 120 days from the date fixed for bid opening under clause 9.0 of GCC, and it shall remain binding upon us and may be accepted at any time before the expiration of that period.

We declare that we have studied the provision of Indian Income Tax Law and other Indian Laws for supply of equipments/materials and the prices have been quoted accordingly.

Unless and until Letter of Intent is issued, this Bid, together with your written acceptance thereof, shall constitute a binding contract between us.

We understand that you are not bound to accept the lowest, or any bid you may receive.

There is provision for Resolution of Disputes under this Contract, in accordance with the Laws and Jurisdiction of Contract, Clause 19 of GCC .

Dated this.....day of.....20.....
Signature..... In the capacity of.....
.....duly authorized to sign for and on behalf of (IN BLOCK CAPITALS).....

FORMAT FOR EMD BANK GUARANTEE

(To be issued in a Non Judicial Stamp Paper of Rs.50/-purchased in the name of the bank)

Whereas [name of the Bidder] (hereinafter called the “Bidder”) has submitted its bid dated [date of submission of bid] for the supply of [name and/or description of the goods] (hereafter called “the Bid”). KNOW ALL PEOPLE by these presents that WE [name of bank]at[Branch Name and address],having our registered office at[address of the registered office of the bank](herein after called —“the Bank”),are bound unto BSES Rajdhani Power Ltd., with its Corporate Office at BSES Bhawan Nehru Place, New Delhi -110019, (herein after called —the “Purchaser”) in the sum of _____ for which payment well and truly to be made to the said Purchaser, the Bank binds itself, its successors, and assigns by these presents. Sealed with the Common Seal of the said Bank this ___ day of __ 20__.

THE CONDITIONS of this obligation are:

If the Bidder withdraws its Bid during the period of bid validity specified by the Bidder on the Bid Form; or

If the Bidder, having been notified of the acceptance of its Bid by the Purchaser during the period of bid validity:

fails or refuses to execute the Contract Form ,if required; or
fails or refuses to furnish the performance security, In accordance with the Instructions to Bidders/GENERAL CONDITIONS.;

We undertake to pay to the Purchaser up to the above amount upon receipt of its first written demand, without the Purchaser having to substantiate its demand, provided that is its demand the purchaser will note that amount claimed by it is due to it, owing to the occurrence of one or both of the two conditions, specifying the occurred condition or conditions.

This guarantee will remain in force up to and including thirty (30) days after the period of bid validity, and any demand in respect thereof should reach the Bank not later than the above date.

(Signature of the bank)

Signature of the witness

PRICE FORMAT

ENQUIRY NO & DATE: NIT: CMC/BR/22-23/RB/PR/RJ/1078

PRICE SCHEDULE

ITEM DESCRIPTION	QTY AS PER RFQ	UOM	EX-WORKS RATE/ UNIT	CGST (%)	CGST AMOUNT	SGST (%)	SGST AMOUNT	IGST (%)	IGST AMOUNT	FREIGHT	LANDED RATE/ UNIT	TOTAL LANDED COST (INR)
SUPPLY OF 11kV INDOOR TYPE 3 WAY MOTORIZED RMU WITH FRTU AS PER TECH SPECS INCLUDING - SUPERVISION OF ERECTION, TESTING, COMMISSIONING OF MOTORIZED RMUs. - TESTING & COMMISSIONING OF FRTU, INCLUDING ALL KIND OF INTERNAL WIRING AND SUCCESSFUL CONFIGURATION AND INTEGRATION OF FRTU WITH SCADA. ARRANGEMENT OF ALL REQUIRED COMMISSIONING SPARES, EQUIPMENT, INSTRUMENTS, TOOLS FOR SUCCESSFUL TESTING AND COMMISSIONING. - MANDATORY SPARES AS PER TECH SPECS	174	Nos										
SUPPLY OF 11kV OUTDOOR TYPE 3 WAY MOTORIZED RMU WITH AUX PT WITH FRTU AS PER TECH SPECS INCLUDING - SUPERVISION OF	348	Nos										

<p>ERECTION, TESTING, COMMISSIONING OF MOTORIZED RMUs. - TESTING & COMMISSIONING OF FRTU, INCLUDING ALL KIND OF INTERNAL WIRING AND SUCCESSFUL CONFIGURATION AND INTEGRATION OF FRTU WITH SCADA. ARRANGEMENT OF ALL REQUIRED COMMISSIONING SPARES, EQUIPMENT, INSTRUMENTS, TOOLS FOR SUCCESSFUL TESTING AND COMMISSIONING. - MANDATORY SPARES AS PER TECH SPECS</p>																
<p>SUPPLY OF 11kV INDOOR TYPE 4 WAY MOTORIZED RMU WITH FRTU AS PER TECH SPECS INCLUDING - SUPERVISION OF ERECTION, TESTING, COMMISSIONING OF MOTORIZED RMUs. - TESTING & COMMISSIONING OF FRTU, INCLUDING ALL KIND OF INTERNAL WIRING AND SUCCESSFUL CONFIGURATION AND INTEGRATION OF FRTU WITH SCADA. ARRANGEMENT OF ALL REQUIRED COMMISSIONING SPARES, EQUIPMENT, INSTRUMENTS, TOOLS FOR SUCCESSFUL TESTING AND COMMISSIONING.</p>	119	Nos														

- MANDATORY SPARES AS PER TECH SPECS												
SUPPLY OF 11kV OUTDOOR TYPE 4 WAY MOTORIZED RMU WITH AUX PT WITH FRTU AS PER TECH SPECS INCLUDING - SUPERVISION OF ERECTION, TESTING, COMMISSIONING OF MOTORIZED RMUs. - TESTING & COMMISSIONING OF FRTU, INCLUDING ALL KIND OF INTERNAL WIRING AND SUCCESSFUL CONFIGURATION AND INTEGRATION OF FRTU WITH SCADA. ARRANGEMENT OF ALL REQUIRED COMMISSIONING SPARES, EQUIPMENT, INSTRUMENTS, TOOLS FOR SUCCESSFUL TESTING AND COMMISSIONING. - MANDATORY SPARES AS PER TECH SPECS	146	Nos										

- Note: 1.Prices shall be Firm
 2.The prices received without break up of ex works, Freight, GST are liable for rejection
 3. Pls. Indicate the exact percentage of taxes in figures and words.
 4. If there is a discrepancy between the unit price and the total price THE UNIT PRICE shall prevail.
 5. Bidders are requested to attach the covering letter head alongwith the price bid indicating reference no and date.

Bidders seal & signature

Annexure – IV

Enquiry No. : CMC/BR/22-23/RB/PR/RJ/1205

COMMERCIAL TERMS AND CONDITIONS

S/NO	ITEM DESCRIPTION	AS PER BRPL	CONFIRMATION OF BIDDER
1	Validity of prices	120 days from date of offer	
2	Price basis	Firm, FOR Delhi store basis, Prices shall be inclusive of all taxes & duties, freight upto Delhi stores. Unloading at stores be in vendor's scope Transit insurance in BRPL scope	
3	Payment Terms	100% payment within 45 days after receipt of material at stores	
4	Delivery schedule	As per our requirement	
5	Defect Liability Period	Warrant shall be 10 years with maintaining resistance less than 5 Ohms from the date of commission or 6 months from the date of delivery whichever is earlier.	
6	Penalty for delay	1% per week of delay of undelivered units or part thereof subject to maximum of 10% of total PO value of undelivered units	
7	Performance Bank Guarantee	<p>Bidder shall initially submit the PBG within 28 days of placement of RC for 1% of RC Value (including GST) valid till RC validity period plus three month claim period. If there is extension in RC validity date, the BG shall be extended accordingly .Upon submission of the performance security, the EMD shall be released.</p> <p>Thereafter bidder shall submit PBG on Purchase Order (PO) basis for 10% of the PO value (including GST).The Performance Bond shall be valid for a period of twenty four months (24) from the date of the commissioning or thirty months (30) from the date of receipt of material (last consignment of PO) at site/stores whichever is earlier plus 3 months towards claim period.</p>	

ENQUIRY NO: CMC/BR/22-23/RB/PR/RJ/1205

NO DEVIATION SHEET

SL NO	SL NO OF TECHNICAL SPECIFICATION	DEVIATION, IF ANY

SIGNATURE & SEAL OF BIDDER

NAME OF BIDDER

Sl No	Item Description	YES/NO
1	INDEX	YES/NO
2	COVERING LETTER	YES/NO
3	BID FORM (UNPRICED) DULY SIGNED	YES/NO
4	BILL OF MATERIAL (UNPRICED)	YES/NO
5	TECHNICAL BID	YES/NO
6	ACCEPTANCE TO COMMERCIAL TERMS & CONDITIONS	YES/NO
7	FINANCIAL BIDS (IN SEALED ENVELOPE)	YES/NO
8	EMD IN PRESCRIBED FORMAT	YES/NO
9	DEMAND DRAFT OF RS 1180/- DRAWN IN FAVOUR OF	BSES RAJDHANI POWER LTD
10	POWER OF ATTORNEY/ AUTHORISATION LETTER FOR SIGNING THE BID	YES/NO

SECTION – V

TECHNICAL SPECIFICATIONS (TS)

MOTORISED RMU WITH FRTU





CMC/BR/24-25/RB/PR/RJ/1205

The detailed technical specifications of Motorised RMU With FRTU

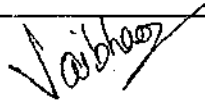
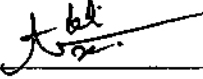
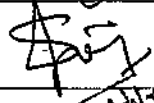

**Specification of
11 kV Ring Main Unit**

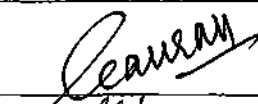
Specification no – BSES-TS-18-MRMU-R1

Rev		1
Date:		07/12/2022
Pages		70
Prepared by	Vaibhav Vaish	
	Abhishek Harsh	
Reviewed by	Srinivas Gopu	
	Nirmal K Gupta	
Approved by	Gaurav Sharma	
	Gopal Nariya	

Index

Record of Revision	3
1.0 Scope of work	4
2.0 Codes & standards.....	4
3.0 Electrical Distribution System Data	5
4.0 11kv RMU System layout.....	5
5.0 RMU panel construction	7
6.0 Circuit breaker (TCB / FCB)	10
7.0 Earth switch (ES)	14
8.0 Requirements of sealed housing live parts	15
9.0 Operational interlocks	15
10.0 Indication & signals (for SCADA / Local).....	16
11.0 Mimic diagram, labels & finish.....	18
12.0 Approved makes	18
13.0 Quality assurance	19
14.0 Inspection & testing.....	19
16.0 Deviations	21
17.0 Drawings Submission.....	22
18.0 Equipment ID	23
Annexure A Scope of supply	25
Annexure B Technical particulars (Data by purchaser)	27
Annexure C Guaranteed Technical Particulars (Data by Supplier).....	28
Annexure D Mandatory Spares and Recommended spares.....	34
Annexure E Typical scheme of RMU	35
Annexure F Drawing of Bimetallic Ring Type Lug	36
Annexure G Specification of 4G Ethernet Modem for FRTU	37
Annexure H Specification For Feeder Remote Terminal Unit For RMU	39
Annexure J Service and Warranty requirement.....	65

Technical Specification of 11 kV Ring Main Unit**Record of Revision**

Revision No	Item / clause no.	Nature of Change	Approved By
1	6.13.1.2	Li-Ion Battery (LIB) to be provided	GS/GN
2	12.1	FRTU – Ashida make included	GS/GN
3	12.3	Relay – C&S (CSDPR-V2-500) make included	GS/GN

Technical Specification of 11 kV Ring Main Unit**1.0 Scope of work**

- 1.1 11kV Motorized RMU with FRTU & Modem shall be supplied as per the specification.
- 1.2 Metering Cubicle (Only with Outdoor RMU, if specified with purchase requisite)
- 1.3 Design, construction, Complete Installation Testing & commissioning of all Motorized RMUs with FRTU at site along with interconnection of all components, DI/DO/AI signals, status monitoring signals to FRTU. Integration of FRTU with SCADA.
- 1.4 FRTU, Modem and Relay Licensed software for programming, configuration, troubleshooting and diagnosis shall be provided.
- 1.5 For scope of supply, refer annexure – A
- 1.6 Mandatory spares shall be supplied along with the RMU as per the list mentioned in Annexure D

2.0 Codes & standards

Materials, equipment and methods used in the manufacture of switchboards shall conform to the latest edition of following –

S No.	Title
Indian Electricity Rules	With latest amendments
Indian electricity act	IE act 2003
IS 3427	A.C. Metal Enclosed Switchgear and Control gear for Rated Voltages Above 1 kV
IS 9920 part 1,3 & 4	High voltage switches above rated voltage 1kv
IS 13118	General requirements of circuit breakers above rated voltage 1kv
IS 3231	Electric Relays for Power System Protection
IEC 60265 part 1	High voltage switches
IEC 60056	High voltage alternating current circuit breakers
IEC 60059	Preferred current ratings of high voltage switchgear
IS 16227/IEC 61869	Current transformers
IS 3156	Voltage Transformer
IEC 60694	Specification for high voltage switchgear
IEC 60298	AC metal enclosed switchgear
IEC 60129	Ac disconnecter and earth switches
IEC 60529	Classification of degrees of protection provided by enclosures
IEC 60255	Electrical relays
IEC 62271	HV Switchgear and Control gear
IEC 62271 – 103	HV Switchgear and Control gear - Switches for rated voltages above 1

Technical Specification of 11 kV Ring Main Unit

	kV up to and including 52 kV
IEC 62271 – 1	HV Switchgear and Control gear – Common Specifications
IEC 62271 – 201	HV Switchgear and Control gear - AC insulation-enclosed switchgear and control gear for rated voltages above 1 kV and up to and including 52 Kv
IEC 60044	Instrument Transformers – Current Transformers
IEC 62271 – 102	HV Switchgear and Control gear – Alternating Current Disconnecter and Earthing Switches

In the event of direct conflict between various order documents, the precedence of authority of documents shall be as follows -

- i. Guaranteed Technical Particulars (GTP)
- ii. Specification including applicable codes & standards
- iii. Approved Vendor Drawings
- iv. Other documents

3.0 Electrical Distribution System Data

3.1	Supply	3 phase AC, 3 wire
3.2	Voltage	11000 volt $\pm 10\%$
3.3	Frequency	50 Hz $\pm 5\%$
3.4	System neutral	Earthed at upstream 11kv source

4.0 11kv RMU System layout

4.1	RMU Configuration	As per scheme given in Annexure E & type as per Purchase requisition
4.1.1	1 Way RMU (Transformer feeder)	Motorized VCB with manual operation facility. Self power relay with protection CTs to be provided. The extension panel DI/DO/AI/Modbus communication signals are to be at single point at RMU for SCADA communication using existing FRTU panel.
4.1.2	3 Way RMU, all are VCB modules.	
4.1.2.1	Cable feeder 1	Motorized VCB with manual operation facility. FPI and CBCT/Phase Sensors to be provided.
4.1.2.2	Cable feeder 2	Motorized VCB with manual operation facility. FPI and CBCT/Phase Sensors to be provided.
4.1.2.3	Transformer feeder	Motorized VCB with manual operation facility. Self power relay with protection CTs to be provided.

Technical Specification of 11 kV Ring Main Unit

4.1.3	4 Way RMU, all are VCB modules.	
4.1.3.1	Cable feeder 1	Motorized VCB with manual operation facility. FPI and CBCT/Phase Sensors to be provided.
4.1.3.2	Cable feeder 2	Motorized VCB with manual operation facility. FPI and CBCT/Phase Sensors to be provided.
4.1.3.3	Transformer feeder 1	Motorized VCB with manual operation facility. Self power relay with protection CTs to be provided.
4.1.3.4	Transformer feeder 2	Motorized VCB with manual operation facility. Self power relay with protection CTs to be provided.
4.2	Extensibility	Both side extensible for 1Way RMU One side extensible for 3Way and 4 Way RMU
4.3	Circuit breaker, disconnecter & earth switch in RMU panel	All shall be non draw out type, fixed position
4.4.1	Insulation medium for panel	SF6 gas in sealed metallic tank
4.4.2	Breakers	Vacuum type (with disconnecter & earth switch)
4.5	Arc interruption chamber for breaker	i) Separate for each breaker ii) Arc interruption chamber of breakers shall be separate from the main insulated tank. (Desirable feature)
4.6	Maximum dimensions for a 3 way panel (3 CBs)	
4.6.1	Width (measured from front)	1250 mm
4.6.2	Depth	800 mm
4.6.3	height	2000 mm
4.7	FRTU	FRTU shall be provided and integrated with RMU and LV compartment with completely wired along with Modem suitable for communicating over 4G/5G (If available during detail engineering, without any price implication) GSM network. Bidder shall demonstrate the data communication of FRTU modem with MCC/BCC for the proposed modem for approval of owner in the Pre Order technical evaluation stage. For detailed specification of FRTU, I/O requirements , refer standard specification of Annexure H
4.8	Modem	Modem should be dual SIM 4G/5G (If available during detail engineering, without any price implication) and shall also have compatibility of 3G/2G network. For detailed technical specification of modem, please refer Annexure G
4.9	Auxiliary transformer	Resin cast

Technical Specification of 11 kV Ring Main Unit

		To be provided as per tender requirement
4.9.1	Rating	11kV/230V
4.9.2	burden	500VA
4.9.3	Primary Fuses	To be provided
4.9.4	2 pole MCB	To be provided for secondary side of the Aux Transformer
4.9.5	Compartment	Separate compartment with padlocking arrangement to be provided.

5.0 RMU panel construction

5.1	Panel type	Metal enclosed, framed, Compartmentalized panel construction.
5.2	Service Location	Indoor, non air conditioned environment / Outdoor with continuous ambient temperature of 50 deg C and shall be suitable for external climatic condition Resistant to water ultraviolet radiation (Canopy shall be provided for outdoor application)
5.3	Mounting	Free Standing
5.4	Overall Enclosure Protection	IP 4X minimum, vermin proof IP 54 minimum (For outdoor duty).
5.5	Doors	Front access with anti theft hinge arrangement, Minimum three hinges. Hinges arrangement shall ensure that door cannot be removed.
5.6	Covers	Bolted for rear access, with handles. Support for handle shall be provided at suitable place on RMU body. All the accessible bolts / screws shall be vandal proof. One set of required Special tools per RMU (if any) shall be in the scope of supply. All kind of nuts and bolts must be stainless steel
5.7	Construction	Indoor RMU: Sheet metal 2.5mm thick CRCA. Outdoor RMU: Pre Galvanized sheet 2.5mm thick with 275GSM Stainless steel tank. 3.0 mm thickness shall be based on validated type tests for 21kA 1sec IAC test and 20kA, 3sec short ckt tests.)
5.8	Base frame	For Panel type design:- Common Base frame shall be made with 75mm ISMC/ISA channel for both Indoor and Outdoor type RMU for holding the both RMU with FRTU compartment. Proper Bolted fixing arrangement shall be provided for erection on RCC foundation. Also, base frame shall be painted with 2 coats of anti rust red oxide and 2 coats of bitumen paint shall be provided.

Technical Specification of 11 kV Ring Main Unit

		<p>For T-type design:- 300 mm - 450 mm height (made with ISA / ISMC) for Indoor & Min. 500 mm for outdoor. Height of the base frame shall be enough to ensure height to suit the operator's convenience.</p> <p>Frame shall be completely covered from all the four sides by MS plate / sheet. Cable box compartment should be extended up-to base-frame bottom to have metallic separation between each of the feeders at base frame level too. Painting should match with RMU shade</p> <p>With fixing bolt for RMU & frame (in case the frame is supplied loose) & foundation bolts.</p>
5.9	Power Cable Clamping Arrangement	Shall be provided for each power cable along with HDPE cable clamps (to suit the cable size from 150 to 400 sq mm PILC / XLPE cable. Exact size shall be provided during drawing approval stage), also cleat shall be adjustable vertically.
5.10	Lifting lugs	Four numbers
5.11	Cable Entry	<p>Bottom</p> <p>3mm metallic gland plate, removable type & split type in two parts, with 1no. 90 mm diameter knocks out punch/hole in the centre (For double cable boxes, Un-drilled gland plate to be supplied. Approval should be taken for the same during drawing submission)</p>
5.12	Cable type & size	3c x 150 / 240 / 300 /400 sq mm Aluminum conductor XLPE/ PILC with armor & PVC outer sheath
5.13	Terminals for 11kv cable termination	Suitable for Ring Type Bimetallic lug as per annexure F
5.13.1	Terminals	M16 size Set of required size of stud suitable for M 16 size Ring type lug & bimetallic washers.
5.13.2	Bimetallic washers	Required (Not applicable for silver quoted bushing)
5.13.3	Right angled boots	Single piece cold shrink type. Minimum 20mm spacing between boots preferred. Type test reports, maintenance replacement plan shall be submitted.
5.13.4		
5.13.5	Cable Test Plug	Preferred with cable test plug facility, without opening of cable compartment
5.13.6	Termination type	suitable for heat shrinkable type
5.13.7	Termination height	For Indoor / Outdoor : Min. height from gland plate shall be 900mm

Technical Specification of 11 kV Ring Main Unit

5.14	Bus bar	Copper (Sizing Calculation to be submitted in support of its Guaranteed S.C. rating / Capability)
5.14.1	Bus bar continuous rated current	630amp (at designed 40 deg.C ambient)
5.14.2	Bus bar short time withstand capacity	20 KA for 3 sec
5.14.3	Bus bar support insulator material	SMC / DMC resin
5.14.4	Maximum temperature rise above reference ambient 40 deg C	In line with Table 3 of IEC62271-1
5.15	Earth bus bar	Aluminium/Tinned Copper flat sized for rated fault duty for 3 sec
5.16	Earth bus internal connection to all non current carrying metal parts	By 2.5 sq mm copper flexible wire, Earth connection point maximum 1 meter away from cable test facility
5.17	Earth bus external connection to owners earth	Studs on both sides with holes for M10 bolt + hardware to readily receive purchaser earth connection
5.18	Cooling arrangement	By natural air without fan
5.19	Panel internal wiring	a) Multi strand flexible color coded PVC insulated Cu wire 1 sq mm (SCADA) b) 1.1KV , PVC insulated 2.5 sq mm cu cable for CT connection. c) Colour of wire (R phase - Red, Y phase – Yellow, B phase – Blue, AC- black, DC – grey, Earth – green) with ferrules at both ends.
5.20	Hardware (Nut, bolts & handle)	Stainless steel (Except termination nut-bolts which are Brass / Tinned Copper)
5.21	Gasket	Neoprene rubber
5.22	Marshalling terminal blocks	1 Sq mm, Nylon 66 material, screw type + 20% spare in each row of TB. Disconnecting type Terminal block to be provided for CT connections
5.23	Panel cover fixing bolts	Allen head 6mm with hexagonal slot. Seals shall be provided between the Panel and removable covers to avoid theft. The seals shall be opened/broken by using specific equipment.

Technical Specification of 11 kV Ring Main Unit

5.24	Padlock facility	Required for all earth switches & all handles
5.25	Bushings for future extensions of RMU	RHS extensible. Should be duly insulated & covered with metallic covers in unused condition, In addition a removable boot cover shall be provided on the extensible bushings.
5.26	Internal Arc classification	
5.26.1	Explosion vents	To ensure operator's safety, design should ensure that gases / flames generated during flash over / blast in any of the compartment, must not come out from the front of RMU as well shall not go to adjacent cable compartment. Internal arc test report (for Cable compartment & other compartments) must be submitted to support above, along with RMU GA drawing indicating these vents. There shall not be any type of holes, gaps etc on the walls of cable termination compartment.
5.26.2	Internal Arc rating	20 kA for 1s
5.26.3	Internal arc classification	Shall comply to the requirements of IEC 62271-200, Accessibility type AFLR. Operators of equipment shall be protected against the effects of an arcing fault in any of the MV compartment at all times , including while carrying out the maintenance works on other compartments
5.27	SF6 Gas Annual Loss	< 0.1% of total mass. Pressure of SF6 gas shall be above the operating limit throughout the life of the equipment.
5.28	VPIS	VPIS shall be provided with terminals facility for phasing purpose. VPIS sensor shall be installed on screened bushing NO/NC Contact shall be provided with VPIS for taking the Live line indication status to remote SCADA through FRTU.
5.29	Push Buttons	On/Off PBS shall be shrouded / covered to prevent accidental operation.

6.0 Circuit breaker (TCB / FCB)

6.1	Type	Three pole, operated simultaneously by a common shaft
6.2	Arc interruption in dielectric medium	Vacuum Bottle
6.3.1	Operating mechanism	Manual and Motorized spring charged stored energy type, remote electrical close / open operation possible.
6.3.2	Manual operation	Possible without removal of motor
6.3.3	Addition / removal of motor	Without overhaul of operating mechanism

Technical Specification of 11 kV Ring Main Unit

6.3.4	Motor rated voltage	24V DC
6.4	ON/OFF push button	On panel front with Protective flap/shrouded to prevent any accidental tripping of breaker.
6.5.1	Continuous rating at design 40 deg C ambient	630amp
6.5.2	Short time withstand capacity	20 KA for 3 sec
6.6	Minimum number of operations at rated current (as per IEC 62271-100)	Mechanical Endurance – Class M1 (2000 operations) Electrical Endurance – Class E2
6.7	Fault making capacity	50 KA peak
6.8	Fault breaking capacity	20 KA Minimum
6.9	Maximum number of operations at rated Fault current (as per IEC 62271-100)	Electrical Endurance – Class E2. To be guaranteed by manufacturer with authorized lab test reports
6.10	Breaker status auxiliary contact	2NO + 2NC wired to terminal block
6.11	For Cable feeder circuit breaker module	
6.11.1	Self powered relay	Not required
6.11.2	CTs	Not required
6.11.3	Fault passage indicator (FPI)	To be provided cable feeders
6.11.4	Fault passage indicator (FPI) (Earth fault and over current protection type)	<ul style="list-style-type: none"> a) To be provided on each and every cable feeder for RMU. FPI shall be earth fault and over current protection type and shall be suitable for remote load monitoring at SCADA for cable feeders. b) CBCT – Split open type suitable for mounting without disconnection of cable for EF. c) Phase sensor – 3 Nos. split open type for short ckt. purpose with mounting arrangement
6.11.5	Connection of CBCT with FPI	Cable connection of FPI with CBCT shall be of pre moulded type on the CBCT side. Cable shall be 2.5 sq.mm cu cable or fiber cable.
6.11.6	Fault Passage Indicator	<ul style="list-style-type: none"> a) Digital type and shall operate as the current exceeds the set value. Flash indication for identifying faults with red LED with one flash for every one sec. Test & reset button 1 NO + 1 NC potential free contact for remote indication FPI power supply unit shall use lithium battery with minimum life of 1000 blinking hours , so that FPI shall continue to function even after main feeder has tripped. FPI shall be powered with 24V DC in all motorized RMU. b) FPI shall be suitable for remote load monitoring at SCADA for Cable feeder. FPI shall be provided with Remote communication capability with SCADA on

Technical Specification of 11 kV Ring Main Unit

		Modbus Protocol. The Load current as measured by FPI shall be communicated to SCADA.
6.11.6.1	Earth Fault Indicator	
6.11.6.1.1	Sensing Current	50 to 400A
6.11.6.1.2	Sensing Time	30 to 100 ms in steps of 10ms.
6.11.6.1.3	Reset Time	0.5 -1-2-3-4 hr
6.11.6.1.4	Resetting Facility	a) Self reset after reset time b) Self reset after restoration of voltage c) Manual d) Remote resetting
6.11.6.1.5	Contact Rating	1A at 230 V
6.11.6.1.6	Degree of Protection	IP 54
6.11.6.1.7	Mounting Arrangement	Surface or Flush Mounting
6.11.6.1.8	Ambient Temperature	-20 to 55 Deg C
6.11.6.2	Short Ckt indicator	
6.11.6.2.1	Sensing Current	200 to 1200 A
6.11.6.2.2	Sensing Time	30 to 100 ms in steps of 10 ms
6.11.6.2.3	Reset time	0.5-1-2-3-4 hr
6.11.6.8	Data by Purchaser	
6.11.6.8.1	System Fault Level	2kA – 8.75kA
6.11.6.8.2	Type of Grounding	Solidly Grounded
6.11.6.8.3	Fault clearing time	100ms
6.11.6.8.4	Cable Type	XLPE , 70 sq.mm to 400 sq.mm
6.12	For Transformer feeder breaker module	
6.12.1	Current transformer	a) 75-150-400 / 1 amp b) Resin Cast Ring type c) Considering three core cable terminations, mounting flexibility shall be provided for CT's (in horizontal & vertical direction both). Additionally, CAUTION marking (by sticker/ paint) shall be provided to avoid CT's installation above the screen of cable. (i.e. earth potential point.) d) Disconnecting type terminal block shall be provided for CT Circuit. e) Change in CT ratio shall be possible from the disconnecting type TB. Any change in CT ratio from CT secondary will not be acceptable.
6.12.2	CT accuracy class	5P10 minimum
6.12.3	CT burden	CT burden should be 20% higher than the connected relay burden.
6.12.4	Protection relay	a) Self powered, Microprocessor based Numerical relay (with backlit LCD display), IDMT over current / earth fault protection with high set element, manual reset type, flush mounted on panel front

Technical Specification of 11 kV Ring Main Unit

		<ul style="list-style-type: none"> b) Relay Setting 10 % to 250% In insteps of 1% c) The relay should record atleast 10 fault events on FIFO basis d) Relay auxiliary supply shall be 24V DC for all motorized RMU. For non Motorized RMU relay shall be with 240V AC auxiliary for remote tripping e) RS-485 Port to be provided on the Relay for remote communication of the parameters to the SCADA through FRTU over IEC103 Protocol. Necessary internal wiring also shall be done between Relay and FRTU. f) Licensed software shall be provided for Relay communication with Laptop along with necessary cables for interconnection between Laptop and Relay (Based on requirement). g) Appropriate wiring to be done to connect all the relays to the FRTU.
6.12.5	Relay auxiliary contacts for remote indication	Potential free contact 1NO + 1NC wired to terminal block
6.12.6	Shunt trip 24V DC (for WTI trip & door limit switch & for remote trip from SCADA.)	To be wired to terminal blocks
6.12.7	Breaking Timing	40 to 60 ms
6.13	FRTU and Associated equipment battery, BHMU and battery charger	
6.13.1	Battery	
6.13.1.1	Battery type	Li-Ion/SMF lead acid battery
6.13.1.2	Rating	<ul style="list-style-type: none"> a) Li-ion battery(LIB) (R1) b) 24VDC, 26Ah(Min) c) Battery provided in enclosure shall be rated for 10 close & 10 open operations of CB as well as 3 hrs backup for all equipment installed inside FRTU Cabinet (mini FRTU load shall be consider as 50W) d) However the actual battery and battery charger sizing shall be finalized by owner during detail engineering and bidder has to supply the finalized size of battery and battery charger without any price implication.
6.13.1.3	Location	Battery shall be kept in shielded compartment in FRTU panel and fixed with rivet and nut bolt. Individual battery terminal shall be wired upto terminal blocks mounted in FRTU cabinet.
6.13.2	Battery Health Monitoring Unit (BHMU)	<ol style="list-style-type: none"> 1. BHMU will have Auto / Manual test facility. In Auto Mode it ensures battery automatic discharge at preset set period with 100W discharge resistor along with suitable algorithm to check the healthiness based on

Technical Specification of 11 kV Ring Main Unit

		<p>rate of discharge.</p> <ol style="list-style-type: none"> 2. In manual Mode PB provided for battery testing. 3. Provision for Bypass mode of BHMU shall also be provided. 4. Output contacts :230V/24V DC -5A <ol style="list-style-type: none"> a. Battery Fail: 1 CO b. Test In process 5. Indications: <ol style="list-style-type: none"> a. BHMU healthy. b. Battery Fail c. Battery Low d. Test On.
6.13.3	Battery charger	2 no's chargers with auto change over using 10A diodes.
6.13.3.1	MCBs at charger input & output supply	Required 2 nos DP MCB for AC Incoming supply All the MCBs shall be easily accessible for operation, with proper labeling. MCB location shall be preferably away from Battery charger location.
6.13.3.2	Charger temperature rise at heat sink at full load for 2 hours	Maximum 55 deg C above ambient of 40 deg C
6.13.3.3	Battery charger cooling method	Natural without any fans
6.13.3.4	Individual CBs DC control	Required with MCB
6.13.3.5	DC power supply for FRTU	24v DC +/- 1 volt thru 2 Amp MCB. FRTU functionality should not effect during DC voltage supply range 18 to 30V DC.
6.13.4	FRTU	FRTU shall be provided and integrated with RMU and LV compartment with completely wired along with Modem suitable for communicating over GSM network. Bidder shall demonstrate the data communication of FRTU modem with MCC/BCC for the proposed modem for approval of owner in the Pre Order technical evaluation stage. For detailed specification of FRTU, I/O requirements , refer standard specification of Annexure H
6.13.5	Modem	Modem should be dual sim 4G/5G (If available during detail engineering, without any price implication) and shall also have compatibility of 3G/2G network. For detailed technical specification of modem, please refer Annexure G
6.13.6	Transducer	DC voltage transducer (4-20mA) for monitoring of DC battery bus voltage.

7.0 Earth switch (ES)

7.1	Type	Three Pole, operated simultaneously by a common shaft, for each Circuit breaker & Load break switch.
7.2	Switching in dielectric medium	Dry Air in sealed medium or SF6 gas

Technical Specification of 11 kV Ring Main Unit

7.3	Operating mechanism for close & open	Manual
7.4	Fault making capacity	50 kA (Desirable)
7.5	Auxiliary contacts	1NO+1NC wired to terminal block
7.6	Disconnect switch (if provided in series with vacuum bottle)	Desirable to be located on purchaser cable connection side of vacuum bottle
7.7	Minimum number of operations at no load (as per IEC 62271-102)	Mechanical Endurance – Class M0(1000 operations)
7.8	Making capacity endurance of earth switch (as per IEC IEC 62271-102)	Class E2 (Min 10 operations)

8.0 Requirements of sealed housing live parts

8.1	Enclosure	Stainless steel enclosure ensure Degree of protection IP67. Non ferrite & Non magnetic grade 304 stainless steel of minimum 3mm thickness. Stainless steel enclosure welding shall be robotic welding type.
8.2	SF6 gas pressure low alarm	To be given along with NO and NC Contracts
8.3	Provision for SF6 gas filling	NRV
8.4	Provision for SF6 gas pressure indication	Analog Manometer with non return valve Manometer with integrated pressure density switch and temperature compensation required
8.5	Arc interruption method for Vacuum circuit breaker	Puffer type / rotating arc type vacuum interrupter
8.6	Potential free contacts for SF6 gas pressure low	1NO +1NC (Desirable) Two distinct SF6 pressure low Potential Free contacts to be provided.

9.0 Operational interlocks

9.1.1	Interlock type	Mechanical. All interlocks shall be preferably guarded by flap, so as to prevent insertion of handle for wrong operation.
9.1.2	Circuit breaker & respective earth switch	Only one in 'close' condition at a time
9.3	Prevent the removal of respective cable covers if circuit breaker is 'ON'	Electrical / Mechanical
9.3	Prevent the closure of circuit breaker if	Electrical / Mechanical

Technical Specification of 11 kV Ring Main Unit

	respective cable cover is open	
9.4	Cable test plug for CB accessible only if Earth switch connected to earth	Mechanical
	For motorized RMUs	
9.5	Prevent motorized operation of CB during manual operation	Electrical / Mechanical Electrical signal shall cut-off completely during manual operation. If CB fail to operate, the supply to motor shall be disconnected after certain time period to prevent burning of motor due to continuous supply.
9.6	Prevent motorized operation of more than one CB at a time	Necessary feature (Electrical)

10.0 Indication & signals (for SCADA / Local)

10.1	Operation counter on front / Inside the RMU LT chamber	To be provided for each Circuit breaker, with minimum four digits & non resettable type
10.2	Cable charge status indication for all CB	Capacitor type voltage indicators with LED on all the phases (Shall be clearly visible in day light)
10.3	Spring charge status indication	On front for breaker
10.4	Earth switch closed indication (For Each CB)	On front
10.5	Circuit breaker On/OFF indication	Green for OFF / Red for ON
10.6	Circuit breaker protection relay operated on fault	Flag
10.7	Fault passage indication on CB	Flag
10.8	Status signals to SCADA-to be wired to marshalling terminal block	2NO + 2NC
10.8.1	CB close / open	potential free contacts
10.8.2	CB Disconnecter Close/Open	Potential free contacts
10.8.3	CB Earth Switch close /open	potential free contacts
10.8.4	Auto trip	potential free contacts
10.8.5	Battery charger Fail	potential free contacts
10.8.6	Protection relay	potential free contacts

Technical Specification of 11 kV Ring Main Unit

	operated	
10.8.7	FPI operated (both E/F and S/C)	potential free contacts
10.8.8	SF6 gas pressure low	potential free contacts (Desirable)
	Spring Charge Status	Potential free contacts
10.8.9	Ready to close signal to control centre to indicate all interlocks are OK	Potential free contacts. Signal to indicate Ready for remote operation from Scada required for entire closing and entire tripping ckt. with all interlocks accounted for (Make : Gogate with P Card / Eqvt after approvals)
10.8.10	Local / Remote Switch (Motorized RMU only)	<ol style="list-style-type: none"> 1. L/R switch is lockable type 2. A manual Local / Remote selector switch shall be provided for each breaker to disable all control outputs by breaking the power supply connection to the control outputs. 3. When in the "Local" position, the Local/ remote switch shall allow testing of all the control outputs of breaker without activating the control outputs to field devices. A status input indication shall be provided for the Local/ Remote switch to allow the SCADA system to monitor the position of the switch. 4. The status of Local/ Remote switch should be wired and configured in FRTU.
10.8.11	Battery charger 1 and 2	Potential Free contacts
10.8.12	Battery	Potential Free contacts
10.8.13	Battery Health Monitoring Unit	Required
10.8.14	Auxiliary Circuit Healthy	Potential free contacts
10.8.15	FRTU Door open	Potential Free Contacts
10.8.16	Interlock Card Operation fail	Potential Free Contacts
10.8.17	Command Acknowledgement	Potential free Contacts
10.9	Commands from SCADA- to be wired to marshalling terminal block	Cable feeder close / open
		Transformer feeder close / open
		FPI Reset
		Interlocking card reset
10.9	RS 485 MODBUS output of Protection relay/FPI	Required

Technical Specification of 11 kV Ring Main Unit**11.0 Mimic diagram, labels & finish**

11.1	Mimic	<ol style="list-style-type: none">1. Mimic diagram (Shall not be accepted with Stickers)2. On panel front with description of function & direction of operation of handles/buttons3. The paint of Mimic shall be same as RMU external paint
11.2	Operating Instructions	Operating instruction chart and Do's & Don'ts in Hindi / local language to be displayed on left / front side of panel enclosure on anodized Al Sheet 16SWG, duly affixed on panel.
11.3	Name plate on panel front	Fixing by rivet only
11.3.1	Material	Anodized aluminum 16SWG / SS
11.3.2	Background	SATIN SILVER
11.3.3	Letters, diagram & border	Black
11.3.4	Process	Etching
11.3.5	Name plate details	<ol style="list-style-type: none">1. Purchaser Name2. Order no and Date3. Month & year of manufacture,4. Equipment type, input & output rating,5. Guarantee period6. SLD7. CT rating8. Aux PT rating9. Manufacturer serial no.10. Breaker operation at rated load, making operation and no load operation
11.4	Labels for meters & indications	The label shall be riveted and not pasted on the panel compartment door. Preferable the labels shall be engraved on the plate. Anodized aluminum with white character on black background OR 3 ply lamicoid
11.5	Danger plate on front & rear side	Anodized aluminum 16 SWG with white letters on red background
11.6	Painting surface preparation	Shot blasting or chemical 7 tank process for CRCA sheet
11.7	Painting external finish	Powder coated epoxy polyester base grade A, shade -RAL 7032, uniform thickness 60 micron minimum
11.8	Painting internal finish	Powder coated epoxy polyester base grade A, shade -white, uniform thickness 60 micron minimum

12.0 Approved makes

12.1	FRTU	ABB / Schneider/ Siemens/Phoenix/Ashida (R1)
12.2	FPI(E/F & S/C)	EMG/Schneider/SIEMENS/C&S

Technical Specification of 11 kV Ring Main Unit

12.3	Self Powered O/C & E/F Relay	Ashida ADR241S -761/C&S (CSDPR-V2-500) (R1)
12.4	Battery Charger	Allan/Gogate
12.5	Boots	3M/Raychem/KD joshi/Shine
12.6	Vacuum Interrupter	CG/ABB/Schneider/BEL
12.7	Modem (GSM 4G+)	Niseva/Lantronix/Pheonix
12.8	Terminals block	Connectwell/Wago/Phoenix/Elmex
12.9	CT and Aux PT	Narayan Power Tech (NPT)/Gilbert Maxwell, Pragati, Nortex
12.10	Interposing relay with freewheeling diode	ABB/Tyco/OEN
12.11	CBCT (Both for Earth fault and Over current protection)	EMG/Schneider/SIEMENS/C&S
12.12	Battery	HBL/Exide
12.13	Wire	Polycab/Havells/Finolex/KEI
12.14	AC & DC MCB	SIEMENS/Havells/C&S/ Schneider
12.15	Disconnecting type fuses	Connectwell/Wago/Phoenix/Elmex
12.16	Protocol converter	ABB/Tyco/OEN
12.17	DC power connector	Wago/Havells/Connectwell
12.18	Battery Health Monitoring Unit	GOGATE/Allan
12.19	Surge protector	Phoenix

Note – Any other make of component offered by the bidder maybe reviewed & approved by purchaser

13.0 Quality assurance

13.1	Vendor quality plan	To be submitted for purchaser approval
13.2	Inspection points in quality plan	To be mutually identified & agreed
13.3	Quality – Process Audits	BSES shall carryout vendor process audits.
13.4	Field quality plan	Bidder to submit field quality plan along with the bid
13.5	Maintenance manual	Bidder to submit maintenance manual along with the bid

14.0 Inspection & testing

14.1	Type test	1. Equipment of type tested quality only, including internal arc test on various compartments like cable
------	-----------	--

Technical Specification of 11 kV Ring Main Unit

		chamber, SF6 gas tank etc.
		2. Type test certificate to be submitted along with offer for scrutiny.
		3. <u>For motorized RMUs – Bidder to submit following test report for DC charger.</u> a) temperature rise test b) voltage regulation test
		4. FRTU type tests as detailed in specification attached in Annexure H
14.2	Routine test	As per relevant Indian standard
14.3	Acceptance test	To be performed in presence of purchaser at manufacturer works. BSES may carry out integration of the FRTU/Modem and BSES SCADA during Inspection stage. OEM to carry out the configuration of both Modem and FRTU in this case to establish connection between FRTU and SCADA. SIM shall be provided by BSES
		1. Physical inspection & BOM, wiring check
		2. Insulation resistance test (Before & after HV test)
		3. HV test for one minute,
		4. Operation & interlock check
		5. Measurement of resistance of main circuit
		6. Voltage Indication check
		7. Functional testing of Fault passage Indicator for Alarm
		8. Primary current injection test for each circuit breaker feeder with relay
		9. Breaker closing & opening time measurement
		10. Functional test of FRTU
		11. Motor Operation
		12. Raw material docs verification

15.0 Shipping, Handling and Site support

15.1	Packing Protection	Against corrosion, dampness, heavy rains, breakage and vibration
15.2	Packing for accessories and spares	Robust wooden non returnable packing case with all the above protection & identification Label
15.3	Packing Identification Label (Anodized Aluminum Plate)	On each packing case, following details are required:
		1. Individual serial number
		2. Purchaser's name
		3. PO number (along with SAP item code, if any) & date
		4. Equipment Tag no. (if any)
		5. Destination

Technical Specification of 11 kV Ring Main Unit

		6. Manufacturer / Supplier's name
		7. Address of Manufacturer / Supplier / it's agent
		8. Description (Configuration of RMU; e.g. 2CCB + 1 FCB, Motorized / Non Motorized, Extensible / Non Extensible) and Quantity must be prominently displayed at least 3 sides of packing box & on top.
		9. Country of origin
		10. Month & year of Manufacturing
		11. Case measurements
		12. Gross and net weights in kilograms
		13. All necessary slinging and stacking instructions
15.4	Shipping	The seller shall be responsible for all transit damage due to improper packing.
15.5	Handling and Storage	1. Manufacturer instruction shall be followed. 2. Detail handling & storage instruction sheet / manual to be furnished before commencement of supply.

16.0 Deviations

16.1	<p>a) Deviations from this specification shall be listed separately by bidder clause wise (as mentioned in below) along with optional offer and has to submit the list along with bid./quotation. BSES will review the deviations and if BSES is agreed with the deviation, seller has to take written confirmation from BSES on deviation during tender evaluation.</p> <p>b) In the absence of any separate list of deviations from the bidder with bid as well as written confirmation from BSES on deviations, it will be assumed by the Buyer that the Seller complies with the Specification fully.</p> <p>c) Any deviations mentioned in any other submitted bid documents (i.e.in filled GTP, Catalog, BSES old approval, buyer's/seller's standards etc) by seller without separate deviation sheets will not consider as a deviation from this tech spec at any stage of contract.</p>
------	--

Sl. No.	Document Name	Clause No.	Deviation	Reason	Merit to BSES

Technical Specification of 11 kV Ring Main Unit**17.0 Drawings Submission**

S.no	Documents to be submitted	With the bid	After Award	
			For Approval	Dispatch
1	Copy of specification along with company seal & signature on each page.	✓		
2	Detailed reference list of customers using the offered product during the last 5 years with similar design and rating	✓		
3	GA / cross sectional drawing of product showing all the views / sections	✓	✓	
4	Manufacturer's quality assurance plan and certification for quality standards	✓	✓	
5	Type test reports for the type, size & rating of product / equipment offered	✓	✓	
6	Complete product catalogue and Manual.	✓	✓	
7	Recommended spare parts and consumable items for five years of operation and spare parts catalogue with price list	✓	✓	
8	BOM	✓	✓	
9	Schematic and wiring drawings for all components		✓	
10	Terminal arrangement & cable box details including gland plate arrangement etc		✓	
11	Quality Assurance plan	✓	✓	
12	Recommended spare parts and consumable items for five years of operation and spare parts catalogue with price list	✓	✓	
13	Detailed installation and commissioning instructions			✓
14	Battery and battery charger sizing calculations			✓
15	Detailed loading drawing to enable the buyer to design and construct foundations		✓	
16	Transport / Shipping dimensions with weights, wheel base details, un tanking height		✓	

Technical Specification of 11 kV Ring Main Unit

S.no	Documents to be submitted	With the bid	After Award	
			For Approval	Dispatch
17	Deviation Sheet (if any)	✓	✓	
18	Inspection and test reports, carried out in manufacturer's works			✓
19	Test certificates of all bought out items			✓
20	Operation and maintenance Instruction as well as trouble shooting charts/ manuals			✓
21	As built Drawings (one set) along with each RMU hard copy			✓
22	As built Drawings soft copy			✓
23	IO termination chart shall be provided along with the schematic drawing for approval. IO Termination chart shall be provided on the inside of FRTU Compartment door.			✓
24	The FRTU and modem Configuration file for every FRTU shall be shared with BSES after successful on-site integration with SCADA			✓
25	FRTU and modem licensed software to be provided to BSES. Any future software upgrades and support to be provided to BSES without any cost implication till warranty period.			✓

18.0 Equipment ID

13.1	Equipment ID	<p>a) A Slot shall be provided on the Compartment door at a clearly readable height from the base level of FRTU compartment. This slot shall be provided with a Fibre card which shall be accessible from inside only but shall be visible outside. Equipment ID shall be painted/printed on the Fibre Card and</p> <p>b) Equipment ID shall be painted on any appropriate face of RMU at a clearly readable height from the base level. Front recommended type face for the signage is True type or Post script</p> <p>c) Font Size: All painting should be in UPPERCASE. Recommended height of 50 mm with spacing between alphabets of 3 mm.</p>
------	--------------	--

Technical Specification of 11 kV Ring Main Unit

- | | | |
|--|--|---|
| | | <ul style="list-style-type: none">d) Total No's of Character: 18e) Height of Font: 50 mmf) Height of Base: 100 mmg) Spacing between alphabets: : 3 mmh) Paint: Base coat – Dense Yellow. Letters – Black Quick Drying paint 2 coats.i) Equipment ID shall be separately provided by BSESj) Equipment ID painting shall complete at factory by seller on each and every motorized RMU before dispatch. |
|--|--|---|

Annexure A Scope of supply

1.0 The scope of supply shall include following

- 1.1 Design, manufacture, testing at manufacturer works before dispatch, packing, delivery and submission of all documentation the 11kV Ring Main Unit (RMU).
- 1.2 11kV RMU shall be as per scheme enclosed as Annexure E.
- 1.3 FRTU along with necessary software's and hardware shall be provided as per detailed specification in Annexure H
- 1.4 Supply of dual SIM Modem (Auto change over, 4G/5G and GSM) for FRTU communication with MCC/BCC as per specification in Annexure G. SIM card shall be provided by BSES.
- 1.5 Battery, Battery Charger and BHMU
- 1.6 Configuration of 11kV RMU shall be as per Purchase Requisition.
- 1.7 Testing & commissioning supervision of all motorized RMUs at site included in the scope of vendor including all operational checks, LV wiring checks, battery / charger checks, VPI , FPI, self powered relay. Supervision of testing & commissioning of all the panels at site. Vendor shall depute the service team with 2 days prior notice from owner.
- 1.8 FRTU customization, parameterization along with integration of FRTU with Control centre has to be carried out at all sites by bidder and OEM engineer.
- 1.9 Guarantee Period for RMU along with all hardware installed inside the FRTU cabinet: 66 months from the date of supply or 60 months from date of commissioning, whichever is earlier.
- 1.10 Service Performance Requirements During Guarantee Period:
 - a) RMU including battery charger: Complaint to be attended on urgent basis and to be resolved within 24 hrs, 1 day from intimation. Adequate quantity of necessary spare should be maintain by bidder service team at Delhi till completion of guarantee period.
 - b) FRTU: After reporting of FRTU modules compliant / failure, within 24 hours FRTU modules shall be replaced by vendor at site. Adequate quantity of necessary spare should be maintain by bidder service team at Delhi till completion of guarantee period.
 - c) Modem: After reporting of Modem compliant / failure, within 24 hours Modem should be rectified / replaced by bidder service team at site. Adequate

Technical Specification of 11 kV Ring Main Unit

quantity of necessary spare should be maintain by bidder service team at Delhi till completion of guarantee period.

- 1.11 Each RMU shall be supplied with 2 sets of Operating Handle.
- 1.12 All the accessories mentioned above shall be supplied along with RMU's as a composite unit. Inside the composite unit, battery and battery charger shall be inbuilt inside RMU compartment and FRTU, modem shall be inbuilt inside LV compartment.
- 1.13 Supplier scope includes training of BSES team – 4 batches (each batch with 4-6 engineers or team member as per BSES requirement.) for minimum 3 days each at factory as well as at BSES site for erection, testing commissioning and maintenance trouble shooting mechanism of Motorized RMU including Automation part. This shall be carried out 1 week from date of 1st shipment/ dispatch. Supplier shall also provide training for Self Powered relay & FRTU at respective manufacturer' factory as well as at BSES site for minimum 3 days for BSES team – 4 batches (each batch with 4-6 engineers or team member as per BSES requirement.) . This is applicable for each and every P.O. of Motorized RMU's.
- 1.14 Unit price for Conversion kit should be offered separately for converting the RMU from single cable termination design to double cable termination design, at site.
- 1.15 BOQ as following –

Sr No	Purchaser Equipment Tag No / SAP code	RMU standard configuration Type	Unit	Quantity
1		<i>Example – Type A2</i>	No	<i>e.g. 1</i>
2		<i>Example – Type R5</i>		
3				
4				

2.0 Submission of documents

	Along with offer	For Approval after award of contract	Final after approval
Documents as given in clause no 17 of specification	3 copies + 1 soft copy in USB	4 copies + 1soft copy in USB	6 copies + 1 soft copy in USB for all type of documents

Technical Specification of 11 kV Ring Main Unit**3.0 Delivery schedule**

3.1	Delivery period start date	-	from date of purchase order
3.2	Delivery period end date	-	as agreed with supplier
3.3	Material dispatch clearance	-	after inspection by purchaser

Annexure B Technical particulars (Data by purchaser)

Sr No	Description	Data by purchaser
1.	Reference design ambient temperature	40 deg C
2.	Maximum ambient temperature	50 deg C
3.	Relative humidity	85%
4.	Seismic zone	Zone IV

Technical Specification of 11 kV Ring Main Unit**Annexure C Guaranteed Technical Particulars (Data by Supplier)**

- a. Bidder shall furnish the GTP format with all details against each clause.
- b. Bidder shall not change the format of GTP or clause description.
- c. Deviation sheets shall be submitted separately along with company seal and sign. Deviation mentioned in submitted GTP or any other documents except deviation sheet shall not be considered as a deviation.

Sr. No.	Description	Data to be filled by Manufacturer
1	11kv RMU (as per scope of supply annexure A)	Separate GTP to be filled for each type of RMU
2	Equipment make	
	Equipment type / brand name	
3	Conformance to design standards as per specification clause no 2.0 –	Yes/No
4	Conformance to specification clause no 3.0 to 17.0 –	Yes/No
5	If NO for pt 3 or pt 4 above, Submission of deviation sheet for each specification clause no –	Yes/No
6	Panel overall dimensions in mm	
6.1	Width (measured from front)	
6.2	Depth	
6.3	height	
7	Panel weight in kg	
8	Panel extensible on both sides – Yes / No	
9	Panel enclosure protection offered	
10	Panel tested for internal arc (Cable & other compartments) –Yes / No	
11	Heat generated by the panel in Kw	
12	Insulation level for complete panel	
12.1	Impulse withstand (Kv peak) -70kvp min	
12.2	Power frequency withstand (Kv rms) – 28kv min	
13	Bus bar	
13.1	Material & grade	
13.2	Bus bar cross section area in sq mm	
13.3	Bus bar rated current in amp i) at designed 40 deg.C ambient	

Technical Specification of 11 kV Ring Main Unit

Sr. No.	Description	Data to be filled by Manufacturer
	ii) at 50 deg.C ambient	
13.4	Max temperature rise above reference ambient of 50 deg C	
13.5	Short time current withstand capacity for 3 seconds (in KA)	
13.6	Bus bar clearances in mm P-P / P-E	
13.7	Bus bar with insulation sleeve / barriers	
13.8	Bus bar support insulator type	
13.9	Bus bar support insulator voltage class	
13.10	Bus bar support insulator minimum creepage distance / mm	
13.11	Earth bus bar material	
13.12	Earth bus bar size	
13.13	Cable compartment	
13.13.1	C-C distance between bushings	
13.13.2	Phase to Phase Clearance (Min)	
13.13.3	Phase to Earth (Min) Clearance	
13.13.4	Impulse Withstand Voltage of design tested	
13.13.5	IAC level – Cable compartment / RMU Tank	
14	Circuit breaker type – VCB	
14.1	Rated voltage & frequency	
14.2	Rated current in amp	
14.3	Rated breaking current – KA rms symmetrical	
14.4	Short time withstand capacity in KA for 3 sec	
14.5	Rated making current - KA peak	
14.6	Breaker total opening time at rated breaking capacity (in milliseconds)	
14.7	Number of breaks per pole	
14.8	Total length of contact travel in mm	
14.9	No of circuit breaker operation cycles (close & open) guaranteed at rated current, Electrical endurance class	25% rated current -
		50% rated current -
		75% rated current -
		100% rated current -

Technical Specification of 11 kV Ring Main Unit

Sr. No.	Description	Data to be filled by Manufacturer
14.10	No of breaker opening operations guaranteed at rated fault current, Electrical Endurance Class	
14.11	No of breaker mechanical operation cycles (close & open) guaranteed at zero current , Mechanical endurance class	
14.12	Contact material	
14.13	Operating mechanism – trip free	
14.14	Motorized/Manual Spring charge type	
14.14.1	Spring charging motor rating - Watt	
14.14.2	Spring charging motor rated DC voltage	
14.14.3	Closing coil wattage & rated DC voltage	
14.14.4	Trip coil wattage & rated DC voltage	
14.14.5	Operating motor voltage with acceptable % variation	
14.15	Minimum permissible SF6 gas pressure (For SF6 type RMU only)	
14.16.1	Capacitor type cable voltage indication provided?	Yes / No
14.16.2	Voltage Presence Indicator- Make / Model	
14.17	Operation counter provided	Yes/ No
15.1	Disconnect switch continuous rating (Amp)	
15.2	Disconnect switch Short time withstand rating -20kA for 3 sec minimum	Yes / No
16	Earth Switch	
16.1	Minimum number of operations at no load- Mechanical Endurance class	
16.2	Making capacity endurance of earth switch – Electrical endurance class	
17	Self Powered Relay – Make / Model	
17.1	CT Input	
17.2	IDMT Setting Range 4 element – Over Current & Earth fault & steps	Overcurrent- Earth Fault- Instantaneous O/C- Instantaneous E/F-
17.3	Operating Time	Over Current – Curves Instantaneous

Technical Specification of 11 kV Ring Main Unit

Sr. No.	Description	Data to be filled by Manufacturer
17.4	Pick up Current	
17.5	Resetting Current	
17.6	Relay Burden	
17.7	Time Accuracy	
17.8	Tripping Coil O/P – type & duration	
17.9	Fault Current Display	
17.10	No of Fault Current Latching with time stamping	
17.11	Display Facility / Type	
17.12	Operational Indicators	
17.13	Potential Free Output Contacts	
17.14	Thermal Withstand Capacity of Relay	
18	Current Transformer- Make	
18.1	Ratio	
18.2	Burden	
18.3	Accuracy Class	
19	Fault Passage Indicator (shall be for both earth fault and over current protection)	
19.1	CBCT	
19.1.1	Type	
19.1.2	Mounting Arrangement	
19.1.3	CT to indicator connection	
19.1.4	ID of sensor	
19.2	Earth Fault/Short Circuit Indicator make	Make / Model
19.2.1	Sensing Current (i) Earth Fault (ii) Short Ckt Indicator	
19.2.2	Sensing Time (i) Earth Fault (ii) Short Ckt Indicator	
19.2.3	Indication	
19.2.4	Reset Time (i) Earth Fault (ii) Short Ckt Indicator	
19.2.5	Resetting Facility	
19.2.6	Output Contact	

Technical Specification of 11 kV Ring Main Unit

Sr. No.	Description	Data to be filled by Manufacturer
19.2.7	Contact Rating	
19.2.8	Aux Power Supply	
19.2.9	Degree of Protection	
19.2.10	Mounting Arrangement	
19.2.11	Ambient Temperature	
20	DC charger rating in amps – min 10 Amp Dual	Yes/No
20.1	MCB rating at 230V AC input of charger	Amp
20.2	MCB rating at 24V DC output of charger	Amp
20.3	Charger heat sink temperature rise (max 55 deg C above ambient 40 deg C)	
20.4	Voltage variation in 24V Dc output for FRTU	(Max +/-1 V)
20.4.5	Charger with natural cooling (no cooling fans)	Yes/No
20.4.6	Charger tested for input supply voltage regulation test (input variation 150V-250V, output Dc voltage variation +/- 1 volt max)	Yes/No
20.4.7	Charger temperature rise test certificate submitted	Yes/No
20.5	DC battery rating in Ah – 26Ah (mini) OR as approved battery sizing during detail engineering, whichever is higher.	Yes/No
20.6	DC charger changeover – Diode rating 10A min OR as approved during detail engineering whichever is higher.	Yes/No
21.1	Cable termination – Height of power terminal from gland plate	mm
21.2	Torque required for tightening terminal lug	
22	Mimic diagram, labels & finish as per cl no 11	Yes / No
23	Submission of RMU / component catalogue	Yes/No
24	Unit price for Conversion kit offered separately for converting the RMU from single cable termination design to double cable termination design	Yes / No
25	FRTU	
25.1	Make & Model No	
25.2	No of DI Modules	



BSES-TS-18-MRMU-R1

Technical Specification of 11 kV Ring Main Unit

Sr. No.	Description	Data to be filled by Manufacturer
25.3	No of DO Modules	
25.4	No of AI Modules	
25.5	Make of Protocol converter	
25.6	Modem	Ethernet Type
25.6.1	Type – Dual SIM 4G/5G and compatible to 3G & 2G Refer Modem Specifications	Yes / No
25.6.2	Make	
25.6.3	Serial port Isolator provided	Yes / No
25.7	Interposing Relay with freewheeling diode	
25.7.1	Make	
25.7.2	Rating	
25.7.3	Model No	
25.8	Terminal Blocks, Disconnecting type	
25.9	MCB make	
26	Surge Protection devices required for	
26.1	Each Serial Ports	
26.1.1	Quantity	
26.1.2	Make and Model	
26.2	Each RJ pot	
26.2.1	Quantity	
26.2.2	Make and Model	
26.3	Charger Output	
26.3.1	Quantity	
26.3.2	Make and Model	

Bidder / Vendor seal / signature

Name of the bidder	
Address of bidder	
Name of contact person	
Telephone no & email id	

Technical Specification of 11 kV Ring Main Unit**Annexure D Mandatory Spares and Recommended spares****1.0 Mandatory Spares (To be supplied with RMU supply)**

Sr No	Description of spare part	Unit	Quantity
1	FRTU (with DI/DO/AI cards)	Nos	Minimum 2 no's of Each type or 5% whichever is higher
2	Modem	Nos	Minimum 2 no's or 5% whichever is higher
3	High gain Antenna	Nos	5
4	Single Phase Transformer as per tender requirement	Nos	1
5	HRC Fuses for Aux Transformer	Nos	20
6	Auxiliary relays	Nos	Minimum 10 no's or 5% whichever is higher
7	Interlock card	Nos	Minimum 2 no's or 5% whichever is higher
8	Motor kit of each type	Nos	Minimum 2 no's or 5% whichever is higher
9	Battery Charger	Nos	Minimum 2 no's or 5% whichever is higher
10	SPD (each type)	Nos	Minimum 2 no's or 10% whichever is higher
11	BHMU Module	Nos	Minimum 2 no's or 5% whichever is higher

2.0 List of recommended spares as following

Sr No	Description of spare part	Unit	Quantity
1	FPI	Nos	limited to 10% of order quantity of RMU
2	VPIS	Nos	limited to 10% of order quantity of RMU
3	Manometer with pressure indicator switch	Nos	limited to 10% of order quantity of RMU
4	Self Powered Relay	Nos	limited to 10% of order quantity of RMU
5	Aux Switches	Nos	limited to 10% of order quantity of RMU
6	CPU with Power Supply Card, I/O Adapter Board, rack,relay board etc	Nos	limited to 10% of order quantity of RMU
7	Battery	Nos	limited to 10% of order quantity of RMU

Any additional spares, if required shall be separately listed by bidder. Unit price for each spare item to be provided.

Technical Specification of 11 kV Ring Main Unit

Annexure E Typical scheme of RMU

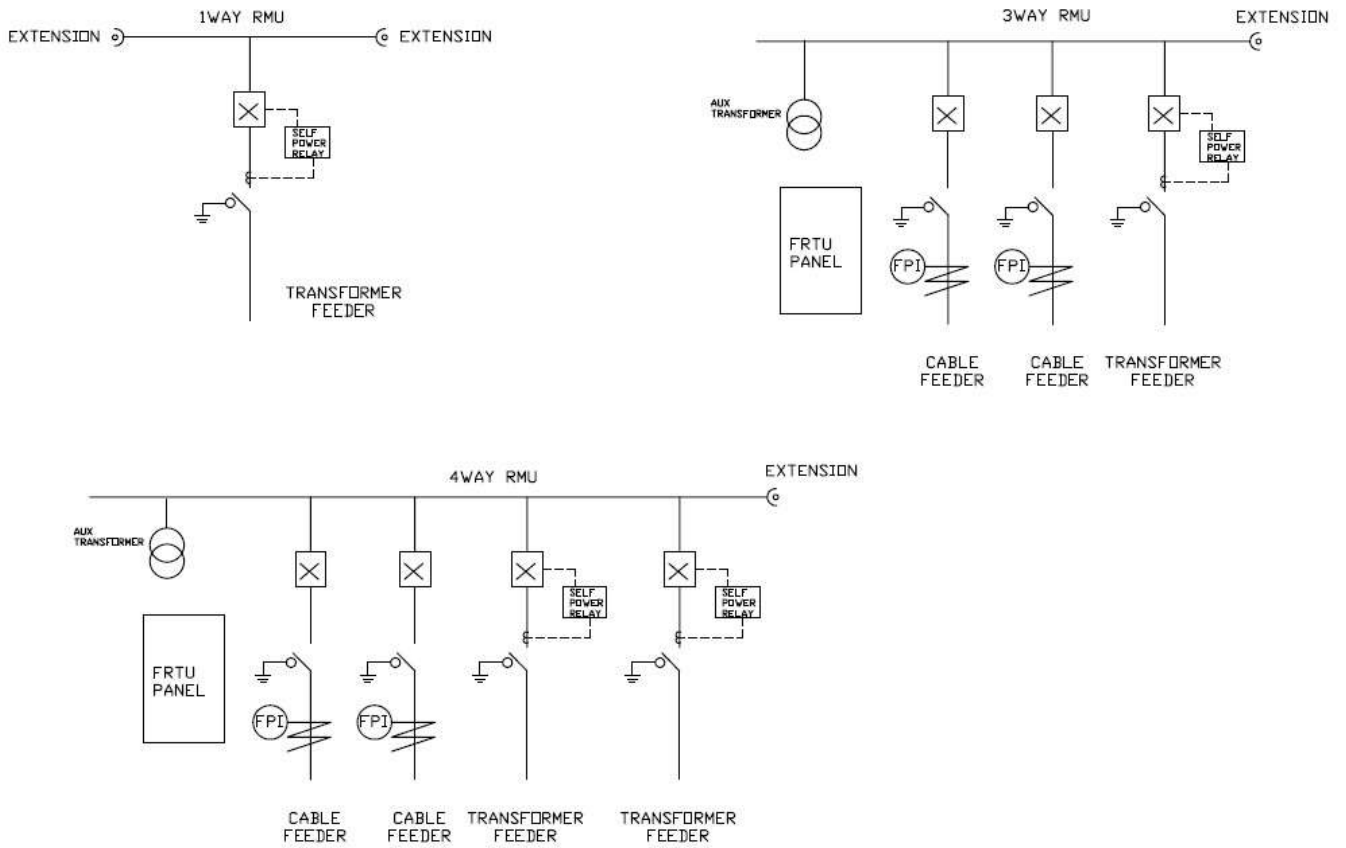

- a) 11kV RMU shall have Feeder Circuit breaker (FCB) and Transformer circuit breakers (TCB) all are motorized
- c) 1Way RMU is extensible on both sides and 3Way 4Way RMU shall be suitable for extension on one sides for addition of TCB or FCB.
- d) Self Power relay is provided for transformer circuit breaker feeder.
- e) Fault passage indicator (FPI) including associated CT & connecting cable is shown by letter 'FPI'.

Technical Specification of 11 kV Ring Main Unit

Annexure F Drawing of Bimetallic Ring Type Lug

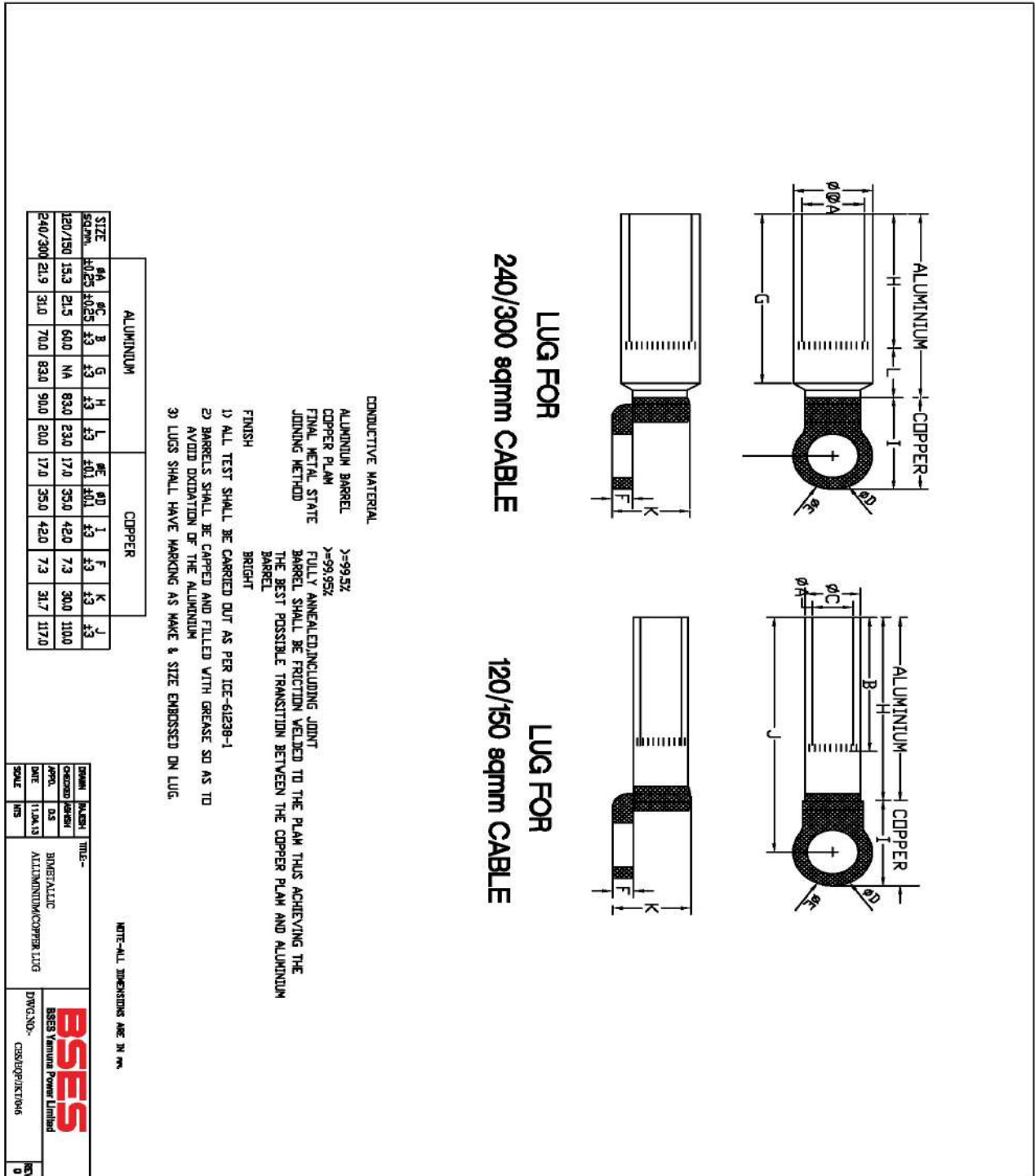

Annexure G Specification of 4G Ethernet Modem for FRTU

1. **Module:** 4G Dual SIM with compatible 3G /GSM GPRS
 - a) FDD LTE: B1 (1920-1980/2110-2170) / B3 (1710-1785/1805-1880) / B8 (880-915/925-960) / B20 (800) MHz
 - b) TDD LTE: B38 (2570-2620) / B39 (1880-1920) / B40 (2300-2400) / B41 (2496-2690)
 - c) HSPA / UMTS: B1 (2100) / B8 (900) /800/850/1900 MHz
 - d) GSM: 900/1800/ MHz Class 10
2. WAN Protocol: PPP/IPCP over Asynchronous HDLC with PAP/CHAP Authentication.
3. Modem shall be compatible with IPv4 & IPv6 scheme
4. Console Interface: RS232 on RJ45 connector.
5. LAN Interface: 10/100 Base-T complying to IEEE 802.3 / ANSI 8802-3 on RJ45 connector.
6. Support for SCADA Protocols in transparent pass through mode.
7. Network Protocols: PPP, IPCP, PAP, CHAP, ARP, IP, ICMP, TCP, UDP, IPSEC, SNTP, TFTP.
8. Support for NAT and Port forwarding.
9. Management: Serial, HTTP,HTTPS, Telnet & via SMS, Port Mapping, Event Log & Upload. Firmware Upgrade
10. Modem shall have self healing capability to recover from dead lock situation.
11. Status Monitoring: ICMP to 4 destinations for Keep Alive & Self Heal. Signal Strength & LEDs.
12. SIM Interface: External with locking provision.
13. AT Commands Interface: Supporting AT commands for dialing from FRTU through RS-232 serial port to modem.
14. Communication Interface: Remote management features like telnet & remote download facility
15. LED Indications: Power ON, Network–Signal strength, SIM availability, Ethernet link
16. Connectors: RJ45 Ethernet Port, SIM Card Holder, DC power connector, SMA Antenna connector

Technical Specification of 11 kV Ring Main Unit

17. Power Supply: 24V DC (with reverse current protection) with 2 numbers Terminal Block without adapter. Modem functionality shall not affect during DC voltage supply range of 18 to 30V DC.
18. Enclosure: Metallic Extrusion
19. Mounting: DIN Rail Mounting
20. Temperature: Operating (-10 to 70 Degree Centigrade), 95% Humidity
21. Antenna: 12dB High Gain Antenna with SMA connector. 15mtr wire length to be provided with the High Gain Antenna.
22. Accessories:
 - a) 1 Meter cable for connecting to external DC power source (24 V)
 - b) 1 Meter Standard Ethernet (Straight) data cable
 - c) Standard Console cable for diagnostic port of Modem
 - d) 1 Meter serial cable for dialing modem from FRTU
23. Certification:
 - a) Conducted Immunity : IEC61000-4-6
Measure emission of the device (referenced to earth) on power mains and to compare them with specified limits to ascertain that the device will not disturb other equipments
Frequency : 0.15MHz to 80MHz
Modulation : 80% AM at 1 KHz
Test Voltage : 3V
 - b) Electrostatic Discharge (ESD):IEC61000-4-2
Check immunity against discharge of static electricity that may occur when a charged operator touches the device
Contact Discharge : 4KV
Air Discharge : 8KV
No of Discharge : 10 at pre-selected spots
Positive & Negative Polarity
 - c) EN55022 CLASS B
Immunity characteristics of the device when subjected to continuous conducted noise
Conducted Emission : Frequency - 150 KHz - 30 MHz
Radiation Emission : Frequency – 30 MHz - 1000 MHz
24. Warranty period: 5 years

Annexure H Specification for Feeder Remote Terminal Unit for RMU

1.0.0 Scope of Supply & Work

This document defines the scope of supply, including spares and scope of work of installation, testing & commissioning including interfacing/ integration with RMU and owners SCADA system for acquisition of real time status and control functions associated with the same.

1.0.1 Scope of Supply

The specification covers design, engineering, manufacturing, FAT, SAT, packaging and delivery of FRTU for RMU automation. The system should be completely wired up with all the required accessories to make the system capable of SCADA data acquisition and controlling of all components of RMU system. The scope of supply also covers the required spares that are to be supplied along with the system as per detail given under Spares, Accessories & Tools, refer clause 1.6.0.

1.0.2 Scope of Work

- a) The specification covers engineering, installation, testing and commissioning of FRTU system, to make the system capable of SCADA data acquisition and controlling of complete accessories of RMU system at site.
- b) The scope also covers the interfacing/ inter-connecting of FRTU with RMU. The details are as per the clause 1.5.3. SAT is also included in the scope of work as defined in the document.
- c) Any firmware up-gradation meets the protocol requirement of MCC/ BCC communication protocol (IEC 60870-5-104) to be made available by the supplier engineer.
- d) End to end testing from MCC/ BCC to be carried out in presence of the supplier engineer. If any change is required for operation and monitoring of the RMU system to be made by the bidder without any price implication to owner.

1.1.0 Applicable Standards

FRTU shall comply with the requirements stated in the latest editions of the following recommendations, standard and specifications:

- a) International Electro technical Commission (IEC),
- b) Institute of Electrical and Electronics Engineering (IEEE),
- c) American National Standards Institute (ANSI),
- d) National Equipment Manufacturers Association (NEMA) standards

1.2.0 Technical Requirements

1.2.1 FRTU Functionalities:

FRTU shall contain all the functions required for SCADA data acquisition and controlling/monitoring of the complete accessories used in RMU.

Technical Specification of 11 kV Ring Main Unit

- a) It should be capable of handling minimum 250 DP(data point) respectively.
- b) FRTU shall have serial port, configurable RS485/RS232 for MODBUS serial and IEC 103 protocol communication.
- c) FRTU shall have TCP/IP port for Modbus TCP/IP and IEC 61850 communication.
- d) Ethernet ports for interfacing with IEC 60870-5-104 protocol to communicate with MCC and BCC.
- e) Ethernet port should be configured for IEC 60870-5-104 protocol as a slave.
- f) Built in optical couplers to isolate the field signals and field communication channels.
- g) FRTU shall support event storage capacity as measured events (500), system events (50), alarms (50) and normal events (250). Events should be stored on the basis of FIFO.
- h) Local viewing of all events shall be possible.
- i) FRTU DI/ DO and AI communication channel capacity should be such that it can fulfill automation of complete substation system.
- j) FRTU shall support web based monitoring from remote as well as local.
- k) All DI/ DO and AI communication channels should have individual LED indications.
- l) FRTU shall support feature of remote configuration as well as diagnosis.
- m) FRTU system shall support communication with 4 Nos. master stations simultaneously.
- n) All DI/DO/AI communication card installed in FRTU shall support HOT swap feature.
- o) As the SCADA/ DMS system will use public domain such as RF/ GPRS etc., therefore it is mandatory to guard the data/ equipment from intrusion/ damage/ breach of security & shall have SSL VPN based security.
- p) FRTU shall support SNMP (Simple Network Management Protocol).
- q) Capability of time synchronization with GPS receiver and SCADA MCC/ BCC.
- r) FRTU system should be modular and expandable.
- s) FRTU should be capable to store the configuration program in detachable flash memory card.
- t) FRTU shall have console port with console cable.

1.2.2 CPU Module:

- a) 32 bit ARM core CPU, operating @ minimum 450 MHz.
- b) Internal memory minimum 128MB and RAM 64MB, suitable for handling the RMU data acquisition and controlling the RMU, DT monitoring, ACB, LT panel and APFC used in substation.
- c) Real Time Clock (RTC)
- d) Display to show the error code and status of the processor.

1.2.3 Communication Ports:

- a) FRTU shall have the following port for communications

S. No	Communication With	Communication Protocol	Physical Layer		Connecting Cable	Required Qty
			Interface	Physical		

Technical Specification of 11 kV Ring Main Unit

				Port		
1	Master station(s)	IEC 60870-5-104	Ethernet	RJ45	CAT VI	1
2	LT panel/ Transformer	IEC 61850	Ethernet	RJ45	CAT VI	1
3	Local Configuration	_	RS232	USB/DB9	Console Cable	1
4	Protection relays	IEC 103	RS485	Terminal Block	Shielded RS485 Twisted Copper Cable	1
5	MFM/FPI	MODBUS	RS485	Terminal Block	Shielded RS485 Twisted Copper Cable	1
6	LT panel/Transformer	MODBUS	RS485	Terminal Block	Shielded RS485 Twisted Copper Cable	1
Total						6

- b) Each Serial port should be capable of handling minimum 10 Nos. devices on the network with same communication settings.
- c) The settings of Ethernet and serial ports should be programmable.
- d) System should have the capability to increase TCP/ IP Ethernet and serial ports for communication by addition of communication modules.

1.2.4 MCC/ BCC Communication Protocol:

- a) FRTU system shall be configured to communicate with MCC/ BCC simultaneously on IEC 60870-5-104 protocol.
- b) FRTU shall support periodic reporting of analog data that shall be configurable upto 1 hour poling delay.
- c) Digital status data shall have higher priorities as compared to the analog data.
- d) Dead band for reporting analog values shall be programmable for the full scale value.

1.2.5 Communication between FRTU, MFMs and Protection Relays:

- a) FRTU can acquire analog values from MFMs/FPIs and protection relay through RS485 serial communication port using MODBUS and IEC 103 protocol respectively.
- b) Communication of ACB/MCCBs on Modbus TCP/IP / IEC 61850 protocol.
- c) MFM/FPI and protection relay will act as slaves to the FRTU. The FRTU shall transmit these analog values to master station by using IEC 60870-5-104 protocol.
- d) To protect the serial communication port(s), optical isolation is required which is mandatory to avoid damage to FRTU channels.

Technical Specification of 11 kV Ring Main Unit**1.2.7 Digital Input Module:**

- a) FRTU shall be capable of accepting isolated potential free contact status inputs.
- b) FRTU shall provide necessary sensing voltage, current, optical isolation for each status input.
- c) FRTU shall be capable to configure re-bounce filtering for each input.
- d) The sensing voltage of input module should be 24V DC.
- e) The FRTU shall accept two types of status input: Single point and double point.
- f) Single point status input represented by 1 Bit in the protocol message whereas double point status input represented by 2 Bits in the protocol message.
- g) FRTU configuration software shall have the capability to invert the DI signal value required in the configuration.
- h) There shall be channel wise visual indication on all DI module installed in the FRTU panel for troubleshooting problems.
- i) Digital Input module should have hot swap compliance.

1.2.8 Digital Output Module:

- a) FRTU shall provide the capability for master station to select and change the state of Digital output points.
- b) These control outputs shall be used to control power system devices such as circuit breakers, isolators and other two state devices which shall be supported by FRTU.
- c) FRTU should also support single command output to reset FPI operation.
- d) The output contact shall be rated to operate RMU motor, ACB, LT MCCB, APFC and other signals used in substation.
- e) In case control output module of FRTU does not provide potential free control output of required rating then separate control output relays shall be provided.
- f) There shall be channel wise visual indication of DOs available in FRTU panel and command issued for any digital channel for troubleshooting the problem.
- g) DO modules should have the capability to configure for a single as well as double command output.
- h) Digital Output module should have hot swap compliance.

1.2.9 Analog Module:

- a) FRTU analog module should be capable of connecting universal type of analog value ($\pm 20\text{mA}$, $\pm 10\text{V}$).
- b) FRTU should have the capability to configure the analog channel for any value of universal analog input through the FRTU configuration software.
- c) Analog module should be 16 Bit, bipolar.
- d) Analog module should have hot swap compliance.
- e) There shall be channel wise visual indication of AIs card available in FRTU panel.

1.2.10 Interfacing of FRTU system with RMU

- a) RMU signal connections should be terminated in RMU bay wise and extension of the signals from the each equipment TB (Terminal Block) to FRTU TB through cable connectors, bay wise.

Technical Specification of 11 kV Ring Main Unit

- b) Separate multi-core cable for Interconnection of FRTU with RMU with suitable size and length.
- c) Male and female connector with cable for interconnection should be provided in FRTU panel.
- d) Minimum 2.5/ 4 sqmm multi-strand copper wire/ cable of suitable length for connecting the battery bank and battery charger placed in FRTU cabinet.
- e) Supply and dressing of inter-connecting cables through suitable size PVC duct are in the supplier scope.
- f) Interconnections should have proper lugs, ferrules etc.

1.2.11 Troubleshooting:

- a) FRTU should be configurable using web based configuration and maintenance tool.
- b) FRTU shall have proper diagnosis tool for troubleshooting the failures related to the following from remotely as well as locally. Supplier shall consider all required configuration and diagnosis cable and software with each supplied FRTU with license if any.
- c) Communication of FRTU with master
- d) Communication of MFM with FRTU
- e) Communication of DI/ DO/AI
- f) Communication with Protection Relay

1.2.12 Programmable Logic Control (PLC):

- a) FRTU shall be provided with the PLC license.
- b) FRTU should have the functionality of logic development and perform the task using its own CPU.
- c) FRTU should have the capability to run more than one PLC tasks at a time.

1.2.13 Cyber Security:

The FRTU shall support the advanced cyber security standard ISO 27002 2005 (previously known as ISO IEC 17799 2005), NERC CIP-009-1 and ISA-99.02.01[5]-[7].

FRTU should have following features:

- a) User level configuration
- b) User wise authentication like system admin, configuration admin, control, operator.
- c) Disabling the DNS
- d) Disabling, enabling & configuration of TCP/ IP and UDP ports.
- e) Door lock alarm integration with FRTU.

1.3.0 General Construction of Enclosure:

- a) FRTU system housed in suitably sized panel, fabricate steel plate with mini 2mm thick frame and 2.0 mm thick CRCA sheet with seven tank process for indoor and for outdoor of protection mini IP 54 with safety lock of good quality. The cabinet

Technical Specification of 11 kV Ring Main Unit

- shall have adequate space for installation of other hardware's like modem, battery charger and battery as well as shall have at least 10% spare space.
- b) It is suitable class of IP 54 protection as per indoor and outdoor applications.
 - c) Enclosure fabricated with double door, swing frame type with proper pad lock arrangement to avert the theft of the equipment fitted inside.
 - d) The component and accessories to be mounted on mounting plate of FRTU.
 - e) Enclosure should have proper illumination, universal type socket and laptop stand and Drawing pocket.

1.4.0 FRTU Power Supply

- a) Power supply for FRTU shall be on 24V DC system which would be made wired from Battery Charger/batteries housed in FRTU cabinet.
- b) The main DC circuits shall be protected by incoming circuit breakers. Each circuit shall be tapped through single pole MCBs so as to provide an individual DC feed to each of the I/O modules, modems and protocol converters. Contractor shall provide maximum power consumption data of each of the type of FRTU. To protect the batteries from the theft the battery in RMU compartment should have separate pad lock arrangement.
- c) Power supply system should have redundant battery charger to provide the supply to FRTU system as well as to charge the battery.
- d) Type 3 Pluggable Surge Protection Device in accordance with IEC 61643 with KEMA & UL approval must be installed at the incoming power supply of FRTU. DIN Rail Mounted Suitable Surge Protection must be installed on all communication lines (i.e. on Ethernet/RS 485 lines)

1.5.0 FRTU Type and Routine Tests

1.5.1 Type Tests

The FRTU's shall have passed type tests carried out by government accredited labs and in accordance with IEC 255-4, 255-5, 255-6, 801-2, and 801-3 to demonstrate that the FRTU's comply with the ratings stated in these standards. As a minimum, certificates for the following type tests shall be furnished:

- a) Dielectric test
- b) Impulse voltage withstand test
- c) High frequency disturbance test
- d) Thermal requirement test
- e) Mechanical requirement test
- f) Limiting dynamic value test
- g) Contact performance test
- h) Electromagnetic radiation susceptibility test
- i) Electrostatic discharge susceptibility test

1.5.2 Routine Tests

The FRTU's shall pass the Manufacturer's standard routine tests in accordance with the referenced standards.

In addition to the tests described in the IEC standards, the routine tests and test report of the FRTU's shall include the following:

- a) Visual tests to confirm that construction and sizing requirements have been met.
- b) Rigorous testing of each input and output function of the FRTU's. This shall include the fault detection and the disturbance data storage functions as well as the operation and performance of the FRTU time and date facilities.
- c) Verification of the use of the FRTU test equipment for maintenance and testing.
- d) Verification of the ability to download parameters and configuration data from the SCADA/DMS master station.
- e) Verification that FRTU software and firmware support FRTU sizing and expansion requirements.
- f) Verification of successful communications (i.e. protocols) at all the required data rates.
- g) Testing for secure operation, including verification that
 - i) Communication errors are detected.
 - ii) SCBO procedures are properly performed for control outputs.
 - iii) No erroneous control operation occurs and no incorrect data is generated when power is turned on or off or when operating on low battery voltage.

1.5.3 SAT

This document exclusively covers the SAT for FRTU system.

After the successful commissioning and testing of the FRTU system and liquidation of all punch points, the system will be put on continuous running mode for a cycle of minimum thirty (30) days after clearance on punch-points. During this period, if the FRTUs performance due to configuration and/ or hardware does not meet the criteria as per Technical Requirements of this document, the cycle will be reset.

During the cycle, availability and operational efficacy in regard of the supplied FRTU system will be checked and after successful validation, SAT will be concluded.

SAT will include the validation of the following:

1. Network
2. FRTU availability and operational efficacy
3. Validation of SOE
4. Indication, Command and Measured data

BSES reserves the right to financially penalize the supplier on failure of SAT as per the technical and tender document.

1.6.0 Spares, Accessories & Tools:

- a) Bidder should provide mandatory spare (refer annexure D) of each and every equipment's and parts of the equipment for 5 years for trouble free operations.
- b) The recommended spares of FRTU and accessories to be approved by the engineering in-charge of SCADA- DMS.
- c) The cost of spares is part of the tender and should not be considered separately.
- d) All software license shall be provided for programing, configuration, troubleshooting and diagnosis shall not be hardware/Machine specific. In case software's are machine or hardware specific mini two numbers of such software shall be supplied.
- e) The bidder shall provide all license software package (system/application/antivirus) required by the system for meeting the intent, functional, parametric and performance requirement of the specification. As a customer support, the bidder shall periodically inform and upgrade the provided software till completion of warranty period.

1.7.0 Software / Firmware

The term software is used in this Technical Specification to mean software or software implemented through firmware. All software shall be implemented according to the Contractor's latest established design and coding standards. Complete and comprehensive documentation shall be provided for all software. Contractor should provide windows based software as it is preferred for its user friendliness.

1.7.1 General

- a) A real-time non-proprietary operating system that is capable of managing the FRTU applications shall be provided.
- b) This software shall provide automatic restart of the FRTU upon power restoration, memory parity errors, hardware failures, and manual request. The software shall initialize the FRTU and begin execution of the FRTU functions without intervention by the SCADA/DMS master station. All restarts shall be reported to the SCADA/DMS.
- c) The software shall be prepared in a high level language and shall be documented in detail. No separate licensing charges or agreements shall attach to the FRTU software or its underlying operating system.
- d) In order to easily support the system under continuously changing site conditions all protocol, configuration, and application data must be contained in easily programmable non-volatile memory such as Flash EPROM.
- e) The FRTU design shall be independent of any communication protocol that would impose restrictions on the flexibility or functionality of the FRTU. Protocol changes shall be accomplished by software/firmware changes only.

1.7.2 Diagnostic Software

Software shall be provided to continuously monitor operation of the FRTU and report FRTU hardware errors to the SCADA/DMS. The software shall check for memory, processor, and input/output errors and failures. It is desirable that internal diagnostics be sufficiently detailed to detect malfunctions to the level of the smallest replaceable component. The FRTU shall facilitate isolation and correction of all failures and shall include features that promote rapid fault isolation and component replacement. All functional module nodes shall

Technical Specification of 11 kV Ring Main Unit

be designed with integrated on-line diagnostic functions. The results of these diagnostics shall be reported to the central processing module. The central module shall store this information and report it to the SCADA/DMS as permitted by the protocol. FRTU shall be able to access from remote (BCC/MCC) for down loading configuration.

1.8.0 Service Life and Warranty Support

Service Life:

BSES prefers that the major equipments of FRTU system shall be capable of complying with this standard, including performing its intended purpose, for a minimum of 5 years from the date of supply.

The supplier shall provide a service support letter containing:

- a) The date at which the product was released for sale.
- b) The anticipated date at which the product will be withdrawn from sale, but support will continue to be supplied.
- c) The anticipated date of when the product support will be withdrawn i.e. spares will no longer be available and technical support will no longer be provided.

1.9.0 Trainings & Hands-on

The supplier personnel who are experienced instructors and who speak understandable English shall conduct training. The supplier shall arrange on its own cost all hardware training platform required for successful training and understanding at BSES works. The supplier shall provide all necessary training material. Each trainee shall receive individual copies of all technical manuals and all other documents used for training. These materials shall be sent to BSES at least one (1) months before the scheduled commencement of the particular training course. Class materials, including the documents sent before the training courses as well as class handouts, shall become the property of BSES. BSES reserves the right to copy such materials, but for in-house training and use only. Hands-on training shall utilize equipment identical to that being supplied to BSES. The schedule, location, and detailed contents of each course will be finalized during BSES and supplier's discussions. If the supplier has utilized 3rd party equipment or outsourced work to a 3rd party then experienced instructors of the 3rd party are required to be part of the training sessions.

1.9.1 FRTU System Hardware Course

A computer system hardware course shall be offered, but at the system level. The training course shall be designed to give BSES hardware personnel sufficient knowledge of the overall design and operation of the system, so that they can correct obvious problems, configure the hardware, perform preventive maintenance, run diagnostic programs, and communicate with contract maintenance personnel. The following shall be covered:

- a) System hardware design architecture overview: Configuration of the system hardware.

Technical Specification of 11 kV Ring Main Unit

- b) Equipment Maintenance: Basic theory of operation, maintenance techniques and diagnostic procedures for each element of the computer system, e.g., processors, auxiliary memories, Ethernet, routers and printers. Configuration of all the hardware equipment.
- c) System Expansion: Techniques and procedures to expand and add equipment such as loggers, monitors and communication channels.
- d) System Maintenance: Theory of operation, maintenance techniques and practices, diagnostic procedures and (where applicable) expansion techniques and procedures. Classes shall include hands-on training for the specific subsystems that are part of BSES equipment or part of similarly designed and configured subsystems. All interfaces to the computing equipment shall be taught in detail.
- e) Operational Training: Practical training on preventive and corrective maintenance of all equipment, including use of special tools and instruments. This training shall be provided on BSES equipment or on similarly configured systems.

1.9.2 FRTU System Software Course

The contractor shall provide a computer system software course that covers the following subjects:

- a) System Programming: Including all applicable programming languages and all stand-alone service and utility packages provided with the system. An introduction to software architecture, effect of tuning parameters (OS software, Network software, database software etc.) on the performance of the system.
- b) Operating System: Including the user aspects of the operating system, such as program loading and integrating procedures, scheduling, management, service and utility functions and system expansion techniques and procedures.
- c) System Initialization and Failover: Including design, theory of operation and practice
- d) Diagnostics: Including the execution of diagnostic procedure and the interpretation of diagnostic outputs.
- e) Software Documentation: Orientation in the organization and use of system software documentation.
- f) Hands-on Training: One week, with allocated computer time for trainee performance of unstructured exercises and with the course instructor available for assistance as necessary.

1.9.3 FRTU Application Software Course

The supplier shall provide comprehensive application software courses covering all applications including the database and display building course. The training shall include:

- a) Overview: Block diagrams of the application software and data flows. Programming standards and program Interface conventions.
- b) Application Functions: Functional capabilities, design and major algorithm. Associated maintenance and expansion techniques.

Technical Specification of 11 kV Ring Main Unit

- c) Software Development: Techniques and conventions to be used for the preparation and integration of new software functions.
- d) Software Generation: Generation of application software from source code and associated software configuration control procedures.
- e) Software Documentation: Orientation in the organization and use of functional and detailed design documentation and of programmer and user manuals.
- g) Hands-on Training: One week, with allocated computer time for trainee performance of unstructured exercises and with the course instructor available for assistance as necessary.

1.9.4 Requirement of Training

The supplier shall provide training for a batch (maximum of 10 people) for five (5) days in two slots (Time of which will be decided by BSES and supplier) on the following courses.

Name of Course:

- a) System Hardware
- b) System Software
- c) Application Software

1.10.0 Drawings & Documents

The bidder shall submit all the standard and customised FRTU documents for review and approval which includes the following:

- a) FRTU function design document
- b) FRTU hardware description document & all the documents referred there in to meet all the clauses of the specification.
- c) FRTU Test equipment user documents
- d) FRTU user guide
- e) FRTU Operation & Maintenance document
- f) FRTU training documentation
- g) FRTU database document
- h) FRTU I/O list (as build) after the execution
- i) FRTU Test procedures
- j) Data Requirement Sheet (DRS) of all items
- k) Protocol documentation including implementation profile etc.
- l) FRTU installation and layout, GA, BOQ, schematics and internal wiring drawings for each FRTU site

Technical Specification of 11 kV Ring Main Unit

Following Technical documents shall be submitted in addition to Commercial Documentation based on Statutory Requirements and shall be submitted along with the bid:

S. No.	Description	For Approval	For Review	Final Submission
1	GTP	✓		✓
2	GA Drawing	✓		✓
3	Installation Instruction			✓
4	Manual/ Catalogues		✓	✓
5	Dimension drawing		✓	✓
6	QA & QC plan	✓	✓	✓
7	Test Certificates	✓	✓	✓

After the award of the contract, bidder shall submit 4 copies of Drawings describing the equipment in detail and forward for approval before final dispatch of the equipment. Soft copy of all the Drawings, GTP, Test certificates shall be submitted for final approval by BSES. All the documents & drawings shall be in English language.

1.11.0 FRTU DI/DO/AI list

RMU configuration	FRTU DI/DO/AI requirement		
	Digital Input Channels	Digital Output Channels	Analogue Channels
3Way & 4Way RMU	48	16	6
5Way	64	32	6
6Way	80	40	6

FRTU configuration DI/ DO/AI Channel requirement is indicated in the Table given below

Signals List for Motorized RMU						
Digital Inputs	Equipments	Signals	DI for 3Way		DI for 4Way	
	Cable Circuit Breaker		CBON	DI1, DI2	2	DI1, DI2
		CBOFF	DI3, DI4	2	DI3, DI4	2
		Disconnecter Open	DI5, DI6	2	DI5, DI6	2
		Disconnecter Close	DI7, DI8	2	DI7, DI8	2
		Earth Status	DI9, DI10	2	DI9, DI10	2
		FPI operated (E/F)	DI11, DI12	2	DI11, DI12	2

Technical Specification of 11 kV Ring Main Unit

		FPI Operated (S/C)	DI13,DI14	2	DI13, DI14	2
		Local/Remote	DI15, DI16	2	DI15, DI16	2
		VPIS Status	DI17, DI18	2	DI17, DI18	2
Circuit Breaker	CB ON	DI19	1	DI19, DI20	2	
	CB OFF	DI20	1	DI21, DI22	2	
	Disconnecter Open	DI21	1	DI23, DI24	2	
	Disconnecter Close	DI22	1	DI25, DI26	2	
	Earth Status	DI23	1	DI27, DI28	2	
	Ready to Close Signal to control centre to indicate all interlocks are OK (including spring charge and trip ckt healthy)	DI24	1	DI29, DI30	2	
	Auto Trip	DI25	1	DI31, DI32	2	
	Local/Remote	DI26	1	DI33, DI34	2	
	SF6 Low	DI27	1	DI35	1	
	VPIS Status	DI28	1	DI36, DI37	2	
	Common Signals	AC Fail	DI29	1	DI38	1
		Battery Charger-1 Fail	DI30	1	DI39	1
		Battery Charger-2 Fail	DI31	1	DI40	1
Command Acknowledgement		DI32	1	DI41	1	
Battery Health Monitoring Unit/Battery in Trouble		DI33	1	DI42	1	
FRTU Door Open		DI34	1	DI43	1	
Interlock Card operation Fail		---	0	---	0	
Auxiliary Circuit Healthy (Control Ckt healthy)		DI35	1	DI44	1	
MOG Alarm from field		DI36	1	DI45	1	
WTI Alarm from field		DI37	1	DI46	1	
APFC	APFC Incomer MCCB Trip	DI38	1	DI47	1	
	APFC Fan MCCB Trip+Other common alarm	DI39	1	DI48	1	
		Total	39	Total	48	
Spare DI			9		0	
TOTAL			48		48	

Signals List for Motorized RMU

Digital Outputs	Signals	DO for 3 way		DO for 4Way	
	Cable CBON	DO1, DO2	2	DO1, DO2	2
Cable CBOFF	DO3, DO4	2	DO3, DO4	2	
FPI Reset	DO5, DO6	2	DO5, DO6	2	

Technical Specification of 11 kV Ring Main Unit

Transformer CB ON	DO7	1	DO7, DO8	2
Transformer CB OFF	DO8	1	DO9, DO10	2
Interlock card remote reset	DO9	1	DO11	1
Modem interlock card remote reset	DO10	1	DO12	1
Modem Remote Reboot	DO11	1	DO13	1
FRTU Remote Reboot	DO12	1	DO14	1
Auto Trip Reset	DO13	1	DO15, DO16	2
	total	13	total	16
Spare DO	DO14-DO16	3	DO16	0

Analog Inputs	LT Palm Temp	AI1
	Oil Temp of Trf.	AI2
	Oil Level	AI3
	Spare	AI4 to AI6

Serial Port	DT Energy Meter Data	SP1
	Relay and FPIs of RMU (Both relays and FPIs to be connected to FRTU through daisy chain)	SP2
	LT ACB/field Data	SP3

1.12.0 Guaranteed Technical Documents

(Vendors shall furnish the General Technical Particulars along with their offer)

Sr. No.	Description	Buyer's Requirement	Vendors Data
1	Vendors Name		
2	Guarantee period	5 yrs	
3	Make of FRTU base module		
4	No. of DI modules	3 x 16	
5	No. of DO modules	2 x 8	
6	No. of AI modules	1x 6	
7	Dimensions & Weight of FRTU	Vendor shall provide	
8	Dimensions of FRTU panel	Vendor shall Provide	
9	Make of protocol converter	Vendor shall provide	

Technical Specification of 11 kV Ring Main Unit

10	Interposing relay with freewheeling diode		
10.1	Make	ABB / SCHNEIDER/SIEMENS	
10.2	Capacity	>8 A	
10.3	Model	CR-P with 2C/O contacts / Eqv	
11	AC & DC MCB	Merlin & Gerin / Protec / Indokopp	
12	Terminal Blocks	Elmex / Connectwell / Phoenix	
13	Disconnecting type fuses	Elmex / Connectwell / Phoenix	
14	Enclosure		
14.1	Indoor		
14.1.1	Sheet steel thickness	Mini 2 mm	
14.1.2	Painting process	7 tank	
14.2	Outdoor		
14.2.1	Galvanized sheet (120GSM min)	Mini 2 mm	
14.2.2	Powder Coating	80 Microns	
14.3	Construction of steel according to IEC 529 , index of protection	IP55	
14.4	Shade	RAL-7035	
14.5	Louvers with filters	2 Nos	

Technical Specification of 11 kV Ring Main Unit**Annexure 'I' 11 kV Metering Cubicle****1.0 General Requirement**

1	Panel Type	Outdoor, Metal enclosed, framed, Compartmentalized panel construction
2	Service Location	Outdoor
3	Mounting	Free Standing
4	Overall Enclosure Protection	IP 54 Minimum (Complete unit i.e. RMU coupled to Metering unit shall be IP54)
5	Panel Fabrication	The metering cubicle shall be fabricated with 2.0mm CRC sheet. Load bearing members and high voltage compartments shall be 3.0 mm. The panel shall be vermin proof and totally enclosed. CT/PT compartment shall be fabricated after bending the M.S. Sheets on three sides and fourth side shall be welded to make the complete assembly tamper proof. Pressure release device/ explosion vent should be provided on the CT PT compartment at the rear side.
6	Compartmentalized panel construction	The panel shall have four separate compartments. All the compartments shall be completely segregated from each other. 1. Meter Compartment 2. CT- PT compartment 3. Incoming 4. Outgoing
7	Meter Compartment	The Upper compartment i.e. the "meter compartment" shall be suitable for housing 3 phase 4 wire Energy Meter (energy meter not in bidder's scope of supply) and associated wiring.
7.1	Double door	1. Double door arrangement as front and back door to meet IP54 requirement. Both the doors should have 02 no's concealed type (Anti Theft) hinges. 2. Front door should have at least 01 no's padlocking and 02 no's sealing arrangements.

Technical Specification of 11 kV Ring Main Unit

7.2	Meter reading Window	<p>Provided on front and back door to enable the meter reader to perform inspection of meter compartment and note down the reading of meter.</p> <ol style="list-style-type: none"> 1. Front Door: window of size 350 (W) X 300 (H) mm approximately with colour-less transparent acrylic sheet and wire mesh welded from inside. 2. Back door: window of size 350 (W) X 300 (H) mm approximately with colour-less transparent acrylic sheet. 																								
7.3	Data Downloading slot	<p>Slot to facilitate installation of data downloading cable with DB9 serial connector.</p> <ol style="list-style-type: none"> 1. Front door: Slot of size 25mm X10 mm (+/- 2 mm) should be provided on front door with sealable cover. 2. Back door: Slot of size 30 mm X 50 mm shall be provided to facilitate installation of data downloading cable. 																								
7.4	Meter hanging arrangement	The meter compartment shall contain hanger arrangement of slotted angle for mounting meter so that meter can be adjusted vertically and horizontally. Two horizontal and two vertical slotted channels should be provided for the same.																								
8	CT PT Compartment	The CT/PT compartment shall be completed welded type and house the 11 KV dry type current transformers (3 no's) and 3 phase dry type potential transformer.																								
8.1	Current Transformers	The metering current transformers shall be suitable for 11 KV; 50Hz effectively earthed neutral system. The CT shall be single core, epoxy resin cast, copper wound primary type with rated burden 5VA and accuracy class 0.5s or better conforming to IS:2705 (Part-I&II). Instrument security factor shall be less than or equal to 10. CTs should have solid copper bus bar type primary terminals for connection with main busbar/bushing terminal. Secondary terminals of CTs should be made of copper or brass.																								
8.2	STC of CT	<table border="1"> <thead> <tr> <th>SL</th> <th>CT ratio</th> <th>Short time rating</th> <th>Size of main Bus bar</th> </tr> </thead> <tbody> <tr> <td>1</td> <td>15 / 5 A</td> <td>6 KA for 1 sec.</td> <td>30 x 4 sqmm</td> </tr> <tr> <td>2</td> <td>30 / 5 A</td> <td>6 KA for 1 sec.</td> <td>30 x 4 sqmm</td> </tr> <tr> <td>3</td> <td>60 / 5 A</td> <td>18KA for 1 seconds</td> <td>30 x 4 sqmm</td> </tr> <tr> <td>4</td> <td>100 / 5A</td> <td>18KA for 1 seconds</td> <td>30 x 4 sqmm</td> </tr> <tr> <td>5</td> <td>150 / 5 A</td> <td>18KA for 1 seconds</td> <td>30 x 4 sqmm</td> </tr> </tbody> </table>	SL	CT ratio	Short time rating	Size of main Bus bar	1	15 / 5 A	6 KA for 1 sec.	30 x 4 sqmm	2	30 / 5 A	6 KA for 1 sec.	30 x 4 sqmm	3	60 / 5 A	18KA for 1 seconds	30 x 4 sqmm	4	100 / 5A	18KA for 1 seconds	30 x 4 sqmm	5	150 / 5 A	18KA for 1 seconds	30 x 4 sqmm
SL	CT ratio	Short time rating	Size of main Bus bar																							
1	15 / 5 A	6 KA for 1 sec.	30 x 4 sqmm																							
2	30 / 5 A	6 KA for 1 sec.	30 x 4 sqmm																							
3	60 / 5 A	18KA for 1 seconds	30 x 4 sqmm																							
4	100 / 5A	18KA for 1 seconds	30 x 4 sqmm																							
5	150 / 5 A	18KA for 1 seconds	30 x 4 sqmm																							

Technical Specification of 11 kV Ring Main Unit

		6	300 / 5 A	18KA for 1 seconds	40 x 6 sqmm
		7	400 / 5 A	21KA for 1 seconds	40 x 6 sqmm
8.3	Potential Transformer	The Potential Transformer shall be dry type Epoxy resin cast, Copper wound suitable for 3 phase 11KV, 50Hz effectively earthed neutral system. The PT shall be connected in star to have ratio $11KV/\sqrt{3} / 110/\sqrt{3}$ V with rated burden of 10VA per phase and accuracy class 0.5 or better conforming to IS:3156 (Part I & II). Primary terminal of PT should be of copper. Secondary terminals of PT should be made of copper or brass.			
8.4	Pressure release device	Pressure release device/ explosion vent should be provided on the CT PT compartment at the rear side.			
9	Incoming	<ol style="list-style-type: none"> 1. Coupled to the breaker module of RMU. 2. Coupling arrangement should meet the IP54 requirement. 			
10	Outgoing	Cable compartment with cover/ door.			
10.1	Cable type & size	3C x 400 sq mm Aluminum conductor XLPE with armor & PVC outer sheath			
10.1	Cable Entry	<ol style="list-style-type: none"> 1. Bottom 2. Gland plate - 3mm metallic, removable & split type in two parts, with 1no. 90 mm diameter knocks out punch/hole in the centre. Approval should be taken for the same during drawing submission 			
10.2	Cable support	'HDPE' cleat(s) shall be provided.			
10.3	Termination Type	Suitable for heat shrinkable type			
10.4	Terminals for 11kV cable termination	<ol style="list-style-type: none"> 1. Suitable for Ring Type Bimetallic lug. 2. Material of Nut, bolts and spring washer- Brass 3. Size of Nut bolt- M16 			
10.5	Termination height	From gland plate 900 mm minimum			
10.6	Right angled boots	Single piece cold shrink type (make – 3M or Raychem)			
11	Panel Wiring	<ol style="list-style-type: none"> 1. Secondary wiring of CTs and PTs shall be done with 2.5 sq. mm PVC insulated cables with stranded copper conductor. 2. CT and PT wiring should run in independent rigid steel conduit pipes of appropriate size from CT/PT compartment 			

Technical Specification of 11 kV Ring Main Unit

		<p>to meter compartment.</p> <ol style="list-style-type: none">3. Conduit pipes shall be clamped with the inner wall of the panel and shall be so laid that none of the wires can be tampered from outside.4. Current transformer and Potential transformer secondary wiring shall be colour coded as per IS and shall be suitably ferruled for identification.5. No link or test terminals shall be provided in wire from CT/PT to meter terminals.
12	Earthing	<ol style="list-style-type: none">1. The assembly comprising of the chassis, framework and the fixed parts of the metal casing shall be provided with two separate earthing terminals of M10 or above.2. These terminals shall be provided over and above all other means provided for securing and earthing metallic enclosures (armour or other metallic coverage) or current-carrying cables.3. The earthing terminals shall be readily accessible and so placed that the earth connection of the CT/ PT chamber is maintained when the cover or any other movable part is removed.4. The earthing terminals shall be protected against corrosion and shall be metallically clean.5. Earth continuity shall be provided to all Gasketed joints by copper braid suitable for rated fault current.6. Under no circumstances shall a movable metal part of the enclosure be insulated from the part carrying the earthing terminals when the movable part is in place.7. The earthing terminals shall be identified by means of the symbol marked in a legible and indelible manner on or adjacent to the terminals.
13	Bushing	<p>Bushing should be made of homogeneous epoxy / polymeric material free from laminations, cavities and other flaws or imperfections that might affect the mechanical or dielectric quality. Bushings shall be designed to have ample insulation level, mechanical strength and rigidity for the conditions under which they will be used. The hollow porcelain bushings shall conform to IS-5621.</p> <p>Bushing clamping accessories, bolts, studs etc shall be hot dip galvanized. All the nuts and washer shall be SS-304. All iron parts shall be hot tin galvanized and all points shall be airtight. All current carrying contact surfaces shall be silver</p>

Technical Specification of 11 kV Ring Main Unit

		plated. The creepage distance of the bushing shall not be less than 31 mm/KV. Bushing shall be tested in accordance with IS-2099. Routine as well as type tests reports in conformity with IS-2099 shall be furnished to the purchaser.
14	Connections	<ol style="list-style-type: none">1. No joint in the primary winding of CT shall be acceptable.2. Connection between CT terminal and bushing terminals shall be done with solid copper busbar of adequate size.3. Flexible copper strip / rope are not acceptable for primary connection.4. PT should be connected to primary busbar through bus bar of appropriate size (connections using flexible conductor are not acceptable).5. All bus bars/ connections in the CT/PT compartment shall be encapsulated in epoxy.
15	Lifting Lug	<ol style="list-style-type: none">1. 04 No's lifting lugs shall be provided at the top of the metering cubicle for transportation.2. All nuts, bolts, flat and spring washers shall be SS only.
16	Height of the Base frame	The total height including base channel shall not be more than 2000 mm. Width and depth should be minimum possible and may be increased suitably to accommodate CT's/PT's.
17	Provision for Sealing	Welded Stud with nut must be provided for the purpose of sealing on the following compartments/ locations. <ol style="list-style-type: none">1. Meter compartment2. Coupling arrangement of RMU and metering cubicle.3. Outgoing cable compartment

2.0 Labels & painting

1	Name plate	The metering cubicles shall be provided with a non detachable type nameplate with legible and indelible marking fixed on the enclosure sheet with welded arrangement so that in case name plate is removed no passage holes are left. (separate name plate should be provided for RMU & metering cubicle)
2.1	Location	Name plate having complete data shall be provided outside as well as inside the metering cubicle at a suitable place where it can be easily read.
2.2	Material	Anodized aluminum 16SWG / SS

Technical Specification of 11 kV Ring Main Unit

2.3	Background	SATIN SILVER
2.4	Letters, diagram & border	Black
2.5	Process	Etching
2.6	Name plate details	<ol style="list-style-type: none">1. BSES Property2. Supplier's name3. P.O. No. & Year of manufacturing4. Sr. No. of metering cubicle5. Particulars of CT's such as ratio, VA burden, accuracy class, SC rating, BIL.6. Particulars of PT's such as ratio, accuracy class, VA burden, BIL.7. Standard connection diagram8. Consumer account no9. Sanctioned load.10. Date of release of connection.
2.7	Labels for CT Ratio	On CT PT compartment by anodized aluminum with white character on black background OR 3 ply lamicoid
2.8	Danger plates	<ol style="list-style-type: none">1. On CT PT compartment and each cable compartment2. Anodized aluminum 16 SWG with white letters on red background
2.9	BSES Insignia	<ol style="list-style-type: none">a) 01 no'sb) Shall be etched on anodized aluminium 16SWG / SS plate.c) Details shall be finalized during drawing approval.
2.10	Enclosure painting surface preparation	Shot blasting or 7 tank chemical process
2.11	Enclosure painting internal/ external finish Powder coated epoxy polyester base	Hot dip galvanizing – 80 micron thick grade A, shade - RAL 7032, uniform thickness 60 micron minimum.

Technical Specification of 11 kV Ring Main Unit**3.0 Technical requirement of CT and PT**

SL	Description	Requirement for CT	Requirement for PT
1	Nominal System Voltage (KV rms)	11KV	11KV
2	Highest System Voltage (KV rms)	12KV	12KV
3	Type	Single phase Indoor CT's	Three phase Star/Star PT.
4	Ration	As specified in purchase enquiry	
5	Accuracy Class	0.5s	0.5
6	Primary fuses		3A
7	Rated frequency	50Hz	50Hz
8	Rated Secondary Current Amp.	5 Amp	N / A
9	Rated continuous thermal current	1.2 times of rated primary current,	NA
10	Max Ratio error	As per IS 2705	As per IS 3156
11	Max Phase angle error	As per IS 2705	As per IS 3156
12	Rated burden	5VA at 0.8 pf (Lag)	10VA/ phase at 0.8 pf (Lag)
13	Rated voltage factor	N / A	1.2 times continuous and 1.5 times for 30 seconds
14	Short time current rating		
14.1	Thermal rating	As provided in section 3.2	N / A
14.2	Dynamic rating	2.55 times of short time thermal current rating	N / A
15	One minute high voltage power frequency withstand voltage		
15.1	On primary winding KV rms On secondary winding KV rms	28KV (rms) for 1 minute for 11 KV class 3KV (rms) for 1 minute	28KV (rms) for 1 minute for 11 KV class 3KV (rms) for 1 minute
15.2	1.2 / 50 impulse withstand voltage	75 KV (peak) for 11 KV class	75 KV (peak) for 11 KV class

Technical Specification of 11 kV Ring Main Unit

16	Winding materials	Copper	Copper
17	Insulation class	Class B	Class B
18	Insulation security factor	< 10	N / A

4.0 Inspection & testing

1	Type test	<ol style="list-style-type: none">1. Metering cubicle shall be type tested as per IS 34272. CT and PTs shall be type tested as per IS2705 and IS3156 respectively.3. Bushings shall be type tested in accordance with IS2099.4. Type tests should not pertain to period earlier than five Years.
2	Routine test	<ol style="list-style-type: none">1. Metering cubicle shall be tested as per IS 34272. CT and PTs will be tested in accordance with IS2705 and IS3156 respectively.3. Temperature rise test will have to be carried out during Inspection.4. During inspection, all routine and acceptance tests shall be carried out in presence of purchaser's representative.
3	Physical Inspection	<ol style="list-style-type: none">1. Checks of all mounting plates / fasteners.2. Checking of components as per drawing.3. Electrical circuit's fasteners tightness / surface area contacts.4. Labels / identification / nameplates.5. All doors checks – safety and accessibility.6. Panel surface finish / smoothness.
4	Right to waive off tests	Reserved by Purchaser

Technical Specification of 11 kV Ring Main Unit**5.0 Guaranteed Technical Particulars (Data by Supplier)**

SL	Description	Requirement	Data By Supplier
1	Name of Manufacturer		
2	Type and Designation	Outdoor type with resin cast CT and PT	
3	Normal system voltage	11KV	
4	Highest system voltage	12KV	
5	Frequency	50Hz	
6	Insulation Class		
7	Impulse Withstand Voltage (On assembled CT-PT set)	75 KV peak	
7.1	One minute power frequency dry withstand voltage (On assembled CT-PT set Primary)	28KV rms	
7.2	Secondary	3KV rms	
8	Current Transformers:	(3 nos. total, 01 no. per phase)	
8.1	Type	Resin cast wound type	
8.2	Transformation ratio (CT Ratio)	As per requirement	
8.3	Rated Output (VA Burden)	5VA	
8.4	Class of accuracy	0.5s	
8.5	Rated continuous thermal current	1.2 times of rated primary current	
8.6	Short time thermal current rating for one second	As per CT ratio and specification	
8.7	Rated Dynamic current	2.55 times of short time thermal current rating	
8.8	Security factor	Less than 10	
8.9	Insulation level	28KV for 1 min	

Technical Specification of 11 kV Ring Main Unit

SL	Description	Requirement	Data By Supplier
8.10	No. of cores	One	
8.11	Max Ratio error	As per IS:2705/1992	
8.12	Max phase angle error	As per IS:2705/1992	
8.13	Max. temp rise over max ambient temp of 50 deg C at rated continuous thermal current at rated frequency & withstand burden	As per IS:2705/1992	
8.14	Make and Grade of epoxy resin		
9	Potential Transformers	(3 Phase 4 wire unit)	
9.1	Burden in VA/Phase	10 VA/phase	
9.2	Transformation ratio	11KV/110V (L-L)	
9.3	Primary Fuse	3A	
9.4	Class of accuracy	0.5	
9.5	Winding connection	Star/Star	
9.6	Insulation level	28KV for 1 min	
9.7	Rated voltage factor and time	1.2 continuous and 1.5 for 30 seconds	
9.8	Temp rise over max ambient temp	Within limits of IS-3156/1992	
9.9	Max phase angle error	Within limits of IS-3156/1992	
9.10	Max Ratio error	Within limits of IS-3156/1992	
9.11	Make and Grade of epoxy resin		
10	Size of main busbar		
10.1	For CT ratio less than and equal to 150/5	30 x 4mm (minimum)	
10.2	For CT ratio of 300/5 and	40 x 6mm (minimum)	

Technical Specification of 11 kV Ring Main Unit

SL	Description	Requirement	Data By Supplier
	400/5		
11	Core material	CRGO (Virgin grade)	
12	Minimum creepage for HT Bushing	31mm/kV	
13	Clearances a. Phase to phase clearance b. Phase to earth clearance		
14	No. of Paint coats a. Primer b. Enameled RAL 7032	2 coats 2 coats	
15	Weight of complete unit		
16	Gauge of a. Meter box b. HT compartments	2mm (min) 3 mm (min)	
17	Dimensions of complete Metering cubicle a. Height (mm) b. Breadth (mm) c. Length (mm)		
18	Meter compartment		
18.1	Dimensions of meter compartment with double door (minimum sheet thickness 2mm) a. Height (mm) b. Breadth (mm) c. Length (mm)		
18.2	Protection class	IP 5X	
18.3	Provision of Acrylic window		
18.4	Provision of slotted channel (40*12mm) suitable for 6mm bolts (4 Nos)	Required	
18.5	Provision of Pad locking & sealing arrangement of door		
18.6	Provision of mounting metering reading port on door.		
19	Metering cubicle mounting	Floor mounting	

Annexure J Service and Warranty requirement**INDEX**

- 1.0 Purpose**
- 2.0 Applicability**
- 3.0 Priority**
- 4.0 Liability**
- 5.0 Warranty Requirements**
- 6.0 Process Requirements**
- 7.0 Documents/records/report submission**
- 8.0 Qualification requirement for service engineers**
- 9.0 Safety**
- 10.0 Communication**
- 11.0 Changes/revision management**

Technical Specification of 11 kV Ring Main Unit**1. Purpose**

This document is prepared to specify the servicing requirement and Warranty / Guarantee handling procedure in case of difficulty that arises in the supplied equipment within the useful service life of the equipment being procured by BSES Rajdhani Power Limited/ BSES Yamuna Power Limited.

2. Applicability

It is applicable to any equipment supplied directly or indirectly for installation / use in BSES Rajdhani Power Limited/ BSES Yamuna Power Limited.

3. Priority

This document which include service, warranty / guarantees management / handling procedures shall be considered a final in case of any contradiction with other contractual document.

4. Liability

- i) Supplier shall be liable to arrange OEM qualified service engineers as and when required by BSES Rajdhani Power Limited/ BSES Yamuna Power Limited to attend defects, trouble shooting to restore equipment health to ensure 100 % capacity availability.
- ii) OEM shall be liable to provide essential spares at reasonable price for entire lifespan of the equipment.
- iii) Service call shall be attended within reasonable time frame as mentioned in this document.
- iv) Service cannot be denied by supplier/OEM till completion of useful life of the equipment.
- v) The commercial liability shall be restricted to supply/service contract provision.

It will be liability of manufacturer /vendor tie up with accessories / component manufacturer to full fill requirement stipulated this document.

5. Warranty Requirements

- i) The equipment failed / malfunctioned within stipulated warranty period shall be attended free of cost for the reasons not attributed to BSES.
- ii) The cost incurred for service, spares, transportation, consumable and manpower / labour shall be borne by supplier.
- iii) OEM is bound to send service engineer to site on request for troubleshooting promptly.
- iv) There is no cap on number of visit or spare replacement required to repair / trouble soot the problem in the equipment during warranty period.

Technical Specification of 11 kV Ring Main Unit

- v) Each break down / problem reported shall be analysed scientifically to establish the root cause of breakdown.
- vi) In case it is established that any component or accessories is not performing satisfactorily or causing repeated failure due to poor performance, manufacturing mistakes, design mistakes or not suitable to our environment condition applicable to NCR region, the OEM shall be liable to rectify or replace the same in all equipment supplied to BSES irrespective of warranty period.
- vii) In case if RMU supplier is not OEM of the equipment / accessories, the supplier will be liable to tie up with OEM to provide service / spares to meet warranty / servicing requirement stipulated in this documents.
- viii) Irrespective of onsite or workshop repairing, it will be responsibility of OEM to maintain work quality to ensure no compromise on performance and useful life of the equipment.

6. Process requirements**6.1 Complain Registration.**

- i) Supplier to provide communication details for complaint registration in O&M Manual, on website as well as shall be printed on the equipment. In case of changes, same shall be communicated to BSES.
- ii) BSES will register complain through a e-mail / telephonic call to the call centre / service centre

6.2 Confirmation and Service time Schedule.

- i) All timing will be counted from date of call registration by BSES till restoration of equipment health at respective site in operation condition satisfactory of BSES engineer.
- ii) Service call confirmation & service engineer visit schedule shall be provided within two hour for working hour call (09:00AM to 06:00PM, Monday to Saturday) and before 10 AM next working day for off working hour calls.
- iii) Emergency trouble shooting calls - within 12 Hrs including spare arrangements.
- iv) Normal trouble shooting call - within 48 Hrs.
- v) On site repairing / component replacement - within 7 days.
- vi) OEM workshop repairing - within 30 days including returning to BSES stores.
- vii) Replacement of complete RMU - within 45 days including delivery to BSES Stores
- viii) The service engineer shall intimate necessary requirement to attend call along with confirmations

Technical Specification of 11 kV Ring Main Unit

- ix) Site visit & Investigation.
- x) The OEM shall depute qualified and experienced engineer to carryout trouble shoot as well as testing and collecting necessary data / details essential for root cause analysis.
- xi) The service engineer shall collect preliminary details to understand and estimate the spare requirement, shutdown time requirement from our respective area engineer whose details will be provided along with service call.
- xii) The necessary tools shall be carried by service engineer attending calls.
- xiii) Service engineer to get call attendance certificate from respective area BSES engineers.
- xiv) Service engineer to intimate necessary precaution required to prevent repetition of problem to respective area BSES engineer as well as CES Team.
- xv) Detailed technical report (root cause analysis) to be submitted to CES Team for records and analysis against each call.

6.3 Recommendation.

- i) Shall be based on scientific study / test results only.
- ii) Shall cover root cause analysis for failure.
- iii) Shall cover spares / component list for repairing.
- iv) Shall cover time requirement.
- v) Shall cover site preparation / condition requirement.
- vi) Other critical measures essential for quality work.

6.4 On Site Repairing.

- i) All site repairing shall be under supervision of OEM engineer and shall meet all OEM recommendation to ensure quality of work.
- ii) All spares arrangement shall be carried out well in advance to minimize outage time. The list must be shared with CES team
- iii) Necessary repairing process to be intimated to CES team in advance. It shall include in process & final quality and performance checks / test.
- iv) The repairing process shall be certified by OEM design / quality expert.
- v) Detailed time schedule and spares arrangement details shall be submitted to CES team for necessary planning.

Technical Specification of 11 kV Ring Main Unit

- vi) The repairing work shall be witness by BSES CES engineer, who may insist in process / performance checks / test in addition to above if felt essential.
- vii) If BSES engineer observed any quality problem / skill problem, may insist for repairing at OEM facility.

6.6 Repairing at OEM facility.

Following requirement shall be fulfilled during OEM workshop repairing work: -

- i) During site inspection, if service engineer felt necessary to send equipment to OEM facility, the same shall be organized by OEM.
- ii) In case if BSES felt that site repairing is not up to the required quality or felt necessary to analyze cause of failure, the same shall be organized by OEM.
- iii) Equipment unpacking, testing and opening for analysis inspection shall be carried out in presence of BSES engineer. It shall be intimated to BSES at least 3 days in advance for necessary travel arrangement.
- iv) If cause of failure observed due to design mistake / manufacturing mistakes, the same shall be rectified in all other similar design equipments without any cost to BSES.
- v) OEM to intimate the final testing for inspection. BSES may depute engineer or third party representative to carryout inspection / testing before dispatch.
- vi) Dispatch shall be carried out only after BSES clearance.
- vii) Necessary lifting, shifting, loading / unloading & transportation arrangement shall be in the scope of OEM / supplier.
- viii) A document required essential for lifting and shifting of equipment will be intimated at least two days in advance.

6.5 Witness / Inspection stages.

Even though OEM is liable for overall quality of work, BSES may witness / Inspection following activity:-

- i) On site inspection, repairing/replacement work.
 - ii) Testing / inspection equipments / any accessories / component to establish the cause of failure.
 - iii) Opening of equipment for internal part inspection.
 - iv) Final testing/inspection before despatch.
- i) Testing / checking of the evidence causing failure / problem.

Technical Specification of 11 kV Ring Main Unit

Note: It will be responsibility of OEM / Supplier to establish with facts, figure, photographs, and evidence to prove that cause of failure not attributed to design.

7. Documents / records / report submission

The following be recorded and provided to BSES by OEM against each call / repairing / rectification works for BSES clearance and future reference:-

- i) Root cause analysis report.
- ii) All test report.
- iii) Minutes of meeting.
- iv) Spares / accessories test report / calibration certificates.
- v) Proof of expenditure for cost incurred to BSES.
- vi) Copy of transportation documents.
- vii) All technical details of parts / accessories being replaced.

8. Qualification requirements for service engineers

i) All work must be carried out by only qualified, experience engineer certified by OEM. BSES may request qualification and experience details if felt necessary.

9. Safety.

- i) All necessary personal protective equipments requirement for the personal and labour will be in the scope of OEM / supplier.
- ii) It will be liability of OEM / Supplier to meet the necessary safety norms , standards, rules & regulation .
- iii) BSES may audit the same during on site work.

10. Communications.

For better coordination, single channel communication must be followed. BSES and OEM / Supplied to communicate to each other their team for communication time to time in case of any changes.

At present, all warranty related communication is to be done with CES team.

11. Changes / revision management.

Necessary approval of O&M analytic cell is essential for changes in this document. In case if any stack holders do not agree or wish to amend its content may send request to BSES O&M analytic cell for approval. The request will be in effect only on consideration and authorized release of revision in document by O&M analytic cell