

## **Tender Notification for**

# **RATE CONTRACT FOR SUPPLY 11KV GRADE ALUMINIUM CONDUCTOR POWER CABLE OF SIZE 11KV 3Cx400 SQ.MM CCD- CABLE IN CO-EXTRUDED DUCT**

**NIT No. CMC/BR/25-26/FK/PR/KG/1245, DT 05.02.2025**

**Due Date for Bid Submission: 25.02.2025 1500HRS**

### **BSES RAJDHANI POWER LTD (BRPL)**

Corporate Identification Number: **U74899DL2001PLC111527**

Telephone Number: +91 11 4910 7235

Website: [www.bsesdelhi.com](http://www.bsesdelhi.com)

## Table of Contents

<b>Section No.</b>	<b>Description</b>
Section-I	Request for Quotation
Section-II	Instruction to Bidders
Section-III	General Terms and Condition –Supply
Section-IV	Quantity & Delivery Requirement
Section-V	Price format- Supply
Section-VI	Vendor Code of Conduct
Annexure-I	Technical Specifications

**SECTION – I**  
**REQUEST FOR QUOTATION**

**1.00 Event Information**

BRPL invites sealed tenders in 2 envelopes for following scope of work

Sl. No.	Description	Estimated Cost (Rs.)	Qty.	Delivery at
1	RATE CONTRACT FOR SUPPLY OF 11KV GRADE ALUMINIUM CONDUCTOR POWER CABLE OF SIZE 11KV 3Cx400 SQ.MM CCD- CABLE IN CO-EXTRUDED DUCT	82.05 Cr	320 KMs	New Delhi Stores

**Note: - The rates quoted shall remain valid for one year from the date of LOI/RC**

**Note: Individual Drum Quantity may vary  $\pm 5\%$ . There will be no positive tolerance on the overall total order quantity. However (-) 2% will be allowed on overall order quantity.**

The bidder must qualify the requirements as specified in clause 2.0 stated below.

All envelopes shall be duly super scribed "**RATE CONTRACT FOR SUPPLY OF 11KV GRADE ALUMINIUM CONDUCTOR POWER CABLE OF SIZE 11KV 3Cx400 SQ.MM CCD- CABLE IN CO-EXTRUDED DUCT at BRPL, New Delhi, NIT No. CMC/BR/25-26/FK/PR/KG/1245.**"

1.01 The schedule of specifications with detail terms & conditions can be obtained from address given below against submission of non-refundable demand draft of **Rs.1180/-** drawn in favour of BSES Rajdhani Power Ltd, payable at Delhi. The tender documents & detail terms and conditions can also be downloaded from the website "**www.bsesdelhi.com --> Tenders --> BSES Rajdhani Power Ltd --> Open Tenders**".

In case tender papers are downloaded from the above website, then the bidder has to enclose a demand draft covering the cost of bid documents.

1.02 Bids will be received up to 25/02/2025 1500 HRS at the address given at 3.01 below. Part A of the Bid shall be opened on 25/02/2025 1615 HRS.

Part B of the Bid will be opened in case of Techno-Commercially qualified Bidders and the date of opening of same shall be intimated in due course. It is the sole responsibility of the bidder to ensure that the bid documents reach this office on or before the last date.

1.03 BSES Rajdhani Power Ltd reserves the right to **accept/reject** any or all Tenders without assigning any reason thereof and alter the quantity of materials mentioned in the Tender documents by **( $\pm$ ) 30%** at the time of placing purchase orders.

1.04 Tender will be summarily rejected if:

- (i) **Earnest Money Deposit (EMD)** of value **Rs 82,05,000/- is not** deposited in shape of FD/Bank Guarantee drawn in favor of BSES Rajdhani Power Ltd, payable at Delhi.
- (ii) The offer does not contain prices indicating break-up towards all taxes & duties in prescribed format
- (iii) Complete Technical details are not enclosed.
- (iv) Tender is received after due date and time.
- (v) Technical offer contains any prices

**2.0 Qualification Criteria: -**

The prospective bidder must qualify all of the following requirements to be eligible to participate in the bidding. Bidders who meet following requirements will be considered as Successful bidder and BRPL has a right to disqualify those bidders who do not meet these requirements.

1. The bidder should have own manufacturing facility for 11KV or higher voltage grade Power Cable since last 3 years. Cable manufacturing and factory incorporation certificate / Undertaking & the details of manufacturing units, locations and works from where supply against this tender shall be proposed to be furnished.
2. The bidder should have manufacturing capacity of minimum 30 Kms per month. Installed Capacity Certificate to be provided.
3. The bidder should have supplied at least 100km of cable size 11KV 3CX300 MM2 or higher voltage or higher size & rating in last 5 years to any utilities/SEB's/PSU's/reputed company (wherein the end user shall be Utility/ SEB's/ PSU's). Summary list of executed Purchase orders to be submitted as per Appendix –VI. Purchase order copies, Material delivery clearance certificate copy or delivery completion certificates or Invoice Copies Data to be submitted.
4. Performance certificate for minimum 2 years satisfactory performance for cable size 11KV 3CX300 mm2 or higher voltage or higher size & rating supplied in last 7 years from at least two utilities/ SEB/ PSUs/ reputed company (wherein the end user shall be Utility/SEB's/PSU's)
5. The Bidder must possess valid ISO 9001:2015 certification and BIS License.
6. Bidder should have Average Annual Sales Turnover of Rs 150 Crores or more in last three (3) Financial Years (i.e., FY 2021-22, 2022-23 & 2023-24). Balance Sheet and duly certified CA certificate to be submitted.
7. The Bidder shall submit an undertaking that "No Litigation" is pending with the BRPL or its Group/Associates Companies.
8. An undertaking (self-certificate) that the bidder has not been blacklisted/debarred by any central/state government institution/Electricity utilities.
9. The bidder must have valid PAN No., GST Registration Number, in addition to other statutory compliances. The bidder must submit the copy of registrations and submit an undertaking that the bidder shall comply all the statutory compliances as per the laws/rules etc. before the start of the supply/work.

**Note:** In case of bidder has a previous association with BRPL/BYPL for similar product and service, the performance feedback for that bidder by BRPL/ BYPL shall only be considered irrespective of performance certificate issued by any third organization.

**3.00 Bidding and Award Process**

Bidders are requested to submit their offer strictly in line with this tender document. **No deviation is acceptable.** BRPL shall response to the clarifications raised by various bidders and the same will be distributed to all participating bidders through website.

**3.01 BID SUBMISSION**

The bidders are required to submit the bids in 2(two) parts to the following address

**Head of Department  
Contracts & Material Department  
BSES Rajdhani Power Ltd  
1<sup>st</sup> Floor, C Block  
BSES Bhawan, Nehru Place  
New Delhi 110019**

PART A: TECHNICAL **BID** comprising of following (1 original + 1 copy)

- EMD in prescribed format
- Non-refundable demand draft for Rs 1180/- in case the forms are downloaded from website
- Documentary evidence in support of qualifying criteria
- Technical Details / Filled in GTP/Type test report etc
- Qualified Manpower available & Organization Chart
- Testing Facilities
- Copies of Orders, Execution /Performance Certificate & Other Documents to support the QC as per clause 2.0
- Original Tender documents duly stamped & signed on each page as token of acceptance
- Acceptance to Commercial Terms and Conditions viz Delivery schedule/period, Payment terms, PBG etc
- Power of Attorney for signing the bid

PART B: FINANCIAL **BID** comprising of (1 original only)

- Price strictly in the Format enclosed indicating Break up of basic price, taxes & duties, transportation etc

### 3.02 TIME SCHEDULE

The bidders should complete the following within the dates specified as under:

<b>S. No.</b>	<b>Steps</b>	<b>Date</b>
1	Date of sale of bid documents	05.02.2025
2	Last date of Queries, if any	20.02.2025
3	Last date of receipt of bid documents	25.02.2025 1500 HRS
4	Date & time of opening of tender – Part A	25.02.2025 1615 HRS

Note: In case last date of submission of bids & date of opening of bids is declared as holiday in BRPL office, the last date of submission will be following working day at the same time.

This is a two part bid process. Bidders are to submit the bids in 2 (two) parts

Both these parts should be furnished in separate sealed covers super scribing NIT no. DUE DATE OF SUBMISSION, with particulars as **PART-A TECHNICAL BID & COMMERCIAL TERMS & CONDITIONS** and **Part-B FINANCIAL**

**BID** and these sealed envelopes should again be placed in another sealed cover which shall be submitted before the due date & time specified.

**Part – A:** Technical Bid should not contain any cost information whatsoever and shall be submitted within the due date.

**PART B:** This envelope will be opened after techno-commercial evaluation and only of the qualified bidders.

**REVERSE AUCTION:** Purchaser reserves the right to use REVERSE AUCTION through SAP-SRM as an optional tool as an integral part of the entire tendering process. All techno-commercially qualified bidders shall participate in this event

Notwithstanding anything stated above, the Purchaser reserves the right to assess bidder's capability to perform the contract, should the circumstances warrant such assessment in the overall interest of the purchaser. In this regard the decision of the purchaser is final.

In case RA is not concluded/conducted for any reasons, a "final no regret" financial bid in a sealed envelope will be called for from all qualified bidders

## **BIDS RECEIVED AFTER DUE DATE AND TIME SHALL BE LIABLE TO REJECTION**

### 4.00 **Award Decision**

- Purchaser intends to award the business on a lowest bid basis, so suppliers are encouraged to submit the bid competitively. The decision to place purchase order/ LOI solely depends on purchaser on the cost competitiveness across multiple lots, quality, delivery and bidder's capacity, in addition to other factors that Purchaser may deem relevant.
- The purchaser reserves all the rights to award the contract to one or more bidders so as to meet the delivery requirement or nullify the award decision without any reason.
- In case any supplier is found unsatisfactory during the delivery process, the award will be cancelled and BRPL reserves the right to award other suppliers who are found fit.
- **Qty Variation:** The purchaser reserves the rights to vary the quantity by **(+/-) 30%** of the tender quantity.
- **Repeat Order:** BRPL reserves the right to place repeat order at the same rates & terms and conditions as per this tender against additional requirement subject to mutual agreement between BRPL & supplier

### 5.00 **Market Integrity**

We have a fair and competitive marketplace. The rules for bidders are outlined in the Terms & Conditions. Bidders must agree to these rules prior to participating. In addition to other remedies available, we reserves the right to exclude a bidder from participating in future markets due to the bidder's violation of any of the rules or obligations contained in the Terms & Condition. A bidder who violates the marketplace rules or engages in behavior that disrupts the fair execution of the marketplace shall be restricted from bidding for a length of time, depending upon the seriousness of the violation. Examples of violations include, but are not limited to:

- Failure to honor prices submitted to the marketplace.
- Breach of the terms of the published in Request for Quotation/ NIT.

**6.00 Confidentiality**

All information contained in this RFQ is confidential and shall not be disclosed, published or advertised in any manner without written authorization from BRPL. This includes all bidding information submitted.

All RFQ documents remain the property of BRPL and all bidders are required to return these documents to BRPL upon request.

Bidders who do not honor these confidentiality provisions will be excluded from participating in future bidding events.

**7.00 Contact Information**

Technical or Commercial clarifications, if any, as regards this RFQ shall be sought in writing and sent by mail to following address. The same shall not be communicated through phone.

	<b>Technical</b>	<b>Commercial</b>
<b>Contact Person</b>	Mr. Amit Tomar	Mr. Pankaj Goyal
<b>Address</b>	BSES Rajdhani Power Ltd , 1 <sup>st</sup> Floor, BSES Bhawan, Nehru Place, New Delhi 110019	BSES Rajdhani Power Ltd , 1 <sup>st</sup> Floor, D Block, BSES Bhawan, Nehru Place, New Delhi 110019
<b>Email</b>	<b>amit.as.tomar@relianceada.com</b> pronab.bairagi@relianceada.com	<b>pankaj.goyal@relianceada.com</b> kumar.ga.gaurav@relianceada.com faiyaz.hussain@relianceada.com

## **SECTION – II**

### **INSTRUCTION TO BIDDERS**

#### **1.00 GENERAL**

BSES Rajdhani Power Ltd hereinafter referred to as "The Purchaser" is desirous of implementing the various Systems Improvement/Repair & Maintenance works at their respective licensed area in Delhi. The Purchaser has now floated this tender for procurement of material as notified earlier in this bid document.

#### **2.00 SCOPE OF WORK**

The scope shall include Design, Manufacture, Testing at works conforming to the Technical Specifications/ IS along with Packing, Forwarding, Transportation and Unloading and proper stacking at Purchaser's stores/ site.

#### **3.00 DISCLAIMER**

This Document includes statements, which reflect various assumptions, which may or may not be correct. Each Bidder shall conduct its own estimation and analysis and should check the accuracy, reliability and completeness of the information in this Document and obtain independent advice from appropriate sources in their own interest.

Neither Purchaser nor its employees will have any liability whatsoever to any Bidder or any other person under the law or contract, the principles of restitution or unjust enrichment or otherwise for any loss, expense or damage whatsoever which may arise from or be incurred or suffered in connection with anything contained in this Document, any matter deemed to form part of this Document, provision of Services and any other information supplied by or on behalf of Purchaser or its employees, or otherwise arising in any way from the selection process for the Supply.

Though adequate care has been taken while issuing the Bid document, the Bidder should satisfy itself that Documents are complete in all respects. Intimation of any discrepancy shall be given to this office immediately.

This Document and the information contained herein are Strictly Confidential and are for the use of only the person(s) to whom it is issued. It may not be copied or distributed by the recipient to third parties (other than in confidence to the recipient's professional advisors).

#### **4.00 COST OF BIDDING**

The Bidder shall bear all cost associated with the preparation and submission of its Bid and the company will be in no case be responsible or liable for those costs.

#### **5.00 BIDDING DOCUMENTS**

The Scope of Work, Bidding Procedures and Contract Terms are described in the Bidding Documents. In addition to the covering letter accompanying Bidding Documents, the Bidding Documents include:

- Request for Quotation (RFQ) - Section - I
- Instructions to Bidders (ITB) - Section - II
- General Terms and Condition Supply (GCC-Supply) - Section –III
- Quantity & Delivery Requirement - Section –IV
- Price Format Supply- Section V
- Vendor Code of Conduct - Section VI
- Technical Specifications - Annexure I



The Bidder is expected to examine the Bidding Documents, including all Instructions, Forms, Terms and Specifications. Failure to furnish all information required by the Bidding Documents or submission of a Bid not substantially responsive to the Bidding Documents in every respect will may result in the rejection of the Bid.

## 6.00 **AMENDMENT OF BIDDING DOCUMENTS**

At any time prior to the deadline for submission of Bids, the Company may for any reasons, whether at its own initiative or in response to a clarification requested by a prospective Bidder, modify the Bidding Documents by amendment.

The Amendment shall be part of the Bidding Documents, pursuant to Clause 5.00, and it will be notified in web site [www.bsesdelhi.com](http://www.bsesdelhi.com), and will be binding on them.

In order to afford prospective Bidders reasonable time in which to take the Amendment into account in preparing their Bids, the Company may, at its discretion, extend the deadline for the submission of Bids. The same shall be published as a corrigendum in website [www.bsesdelhi.com](http://www.bsesdelhi.com).

Purchaser shall reserve the rights to following:

- extend due date of submission
- modify tender document in part/whole
- cancel the entire tender

**Bidders are requested to visit website regularly for any modification/clarification/ corrigendum/ addendum of the bid documents.**

## **PREPARATION OF BIDS**

### 7.00 **LANGUAGE OF BID**

The Bid prepared by the Bidder and all correspondence and documents relating to the Bid exchanged by the Bidder and the Purchaser shall be written in the English Language. Any printed literature furnished by the Bidder may be written in another Language, provided that this literature is accompanied by English translation, in which case, for purposes of interpretation of the Bid, the English translation shall govern.

### 8.00 **DOCUMENTS COMPRISING THE BID**

The Bid prepared and submitted by the Bidder shall comprise the following components:

- Bid Form, Price & other Schedules (strictly as per format) and Technical Data Sheets completed in accordance with Technical Specification
- All the Bids must be accompanied with the required EMD as mentioned in the Section-I against each tender.
- Tender documents duly stamped and signed on each page by authorized signatory

### 9.00 **BID FORM**

9.01 The Bidder shall submit one "Original" and one "Copy" of the Un-priced Bid Form, Price Schedules & Technical Data Sheets duly filled in as per attached specification/ BOM etc enclosed.

### 10.00 **EMD**

The bidder shall furnish, as part of its bid, an EMD amounting as specified in the RFQ. The EMD is required to protect the Purchaser against the risk of Bidder's conduct which would warrant forfeiture.

The EMD shall be denominated in any of the following form:

- (a) Fixed deposit (lien marked in favor of BSES RAJDHANI POWER LTD.) payable at Delhi.
- (b) Bank Guarantee valid for One hundred Twenty (120) days plus minimum 30 days claim period after due date of submission or amended due date of submission drawn in favour of BSES Rajdhani Power Ltd, BSES Bhawan, Nehru Place, New Delhi 110019

The EMD may be forfeited in case of:

- (a) The Bidder withdraws its bid during the period of specified bid validity.
- (b) In the case of a successful Bidder, if the Bidder does not
  - (i) Accept the Purchase Order or
  - (ii) Furnish the required performance security BG.

Please note that bank details as below have been provided only for the purpose of making BG for EMD.

Beneficiary Name: BSES Rajdhani Power Limited

Bank Name : State Bank of India, New Delhi

A/c No.: 40214783615

IFSC Code : SBIN0009601

#### 11.00 **BID PRICES**

11.01 Bidders shall quote for the entire Scope of Supply with a break-up of prices for individual items and Taxes & Duties. The total Bid Price shall also cover all the Supplier's obligations mentioned in or reasonably to be inferred from the Bidding Documents in respect of Design, Supply, Transportation all in accordance with the requirement of Bidding Documents. The Bidder shall complete the appropriate Price Schedules included herein, stating the Unit Price for each item & total Price with taxes, duties & freight up to destination.

11.02 The prices offered shall be inclusive of all costs as well as Duties, Taxes and Levies paid or payable during execution of the supply work, breakup of price constituents, should be there.

11.03 Prices quoted by the Bidder shall be "**FIRM**" and not subject to any price adjustment during the performance of the Contract. A Bid submitted with an adjustable price/ Price Variation Clause will be treated as non-responsive and rejected.

#### 12.00 **BID CURRENCIES**

Prices shall be quoted in Indian Rupees Only.

#### 13.00 **PERIOD OF VALIDITY OF BIDS**

13.01 Bids shall remain valid for 120 days from the due date of submission of the Bid & subsequent corrigendum/ amendment/ extension of due date of submission.

13.02 Notwithstanding Clause 13.01 above, the Purchaser may solicit the Bidder's consent to an extension of the Period of Bid Validity. The request and the responses thereto shall be made in writing and sent by post/ courier.

#### 14.00 **ALTERNATIVE BIDS**

Bidders shall submit Bids, which comply with the Bidding Documents. Alternative Bids will not be considered. The attention of Bidders is drawn to the provisions regarding the rejection of Bids in the terms and conditions, which are not substantially responsive to the requirements of the Bidding Documents.

#### 15.00 **FORMAT AND SIGNING OF BID**

15.01 The original Bid Form and accompanying documents, clearly marked "Original Bid" and "copy" must be received by the Purchaser at the date, time and place specified pursuant to Clauses 15.0 and 16.0. In the event of any discrepancy between the original and the copy, the original shall govern.

15.02 The original and copies of the Bid shall be typed or written in indelible ink and shall be signed by the Bidder or a person or persons duly authorized to sign on behalf of the Bidder. **Such authorization shall be indicated by written Power-of-Authority accompanying the Bid.**

15.03 The Bid shall contain no interlineations, erasures or overwriting except as necessary to correct errors made by the Bidder, in which case such corrections shall be initialed by the person or persons signing the Bid.

#### **SUBMISSION OF BIDS**

#### 16.00 **SEALING AND MARKING OF BIDS**

16.01 Bid submission: One original & one Copy (hard copies) of all the Bid Documents shall be sealed and submitted to the Purchaser before the closing time for submission of the bid.

16.02 The Technical Documents and the EMD shall be enclosed in a sealed envelope and the said envelope shall be super scribed with —"**Technical & EMD**". The price bid shall be inside another sealed envelope with super scribed "Financial Bid ". Both these envelopes shall be sealed inside another big envelope. All the envelopes should bear the Name and Address of the Bidder and marking for the Original and Copy. The envelopes should be super scribed with —"Tender Notice No. & Due date of opening".

16.03 The Bidder has the option of sending the Bids in person. Bids submitted by Email/Telex/Telegram /Fax will be rejected. No request from any Bidder to the Purchaser to collect the proposals from Courier/Airlines/Cargo Agents etc shall be entertained by the Purchaser.

#### 17.00 **DEADLINE FOR SUBMISSION OF BIDS**

17.01 The original Bid, together with the required copies, must be received by the Purchaser at the address specified earlier no **later than the due date specified earlier.**

17.02 The Purchaser may, at its discretion, extend the deadline for the submission of Bids by amending the Bidding Documents, in which case all rights and obligations of the Purchaser and Bidders previously subject to the deadline will thereafter be subject to the deadline as extended.

#### 18.00 **ONE BID PER BIDDER**

Each Bidder shall submit only one Bid by itself. **No Joint Venture is acceptable.** A Bidder who submits or participates in more than one Bid will cause all those Bids to be rejected.

#### 19.00 **LATE BIDS**

Any Bid received by the Purchaser after the deadline for submission of Bids prescribed by the Purchaser, pursuant to Clause 16.0, will be declared "Late" and shall be rejected and returned unopened to the Bidder.

## 20.00 **MODIFICATIONS AND WITHDRAWAL OF BIDS**

The Bidder is not allowed to modify or withdraw its Bid after the Bid's submission.

## **EVALUATION OF BID**

### 21.00 **PROCESS TO BE CONFIDENTIAL**

Information relating to the examination, clarification, evaluation and comparison of Bids and recommendations for the award of a contract shall not be disclosed to Bidders or any other persons not officially concerned with such process. Any effort by a Bidder to influence the Purchaser's processing of Bids or award decisions may result in the rejection of the Bidder's Bid.

### 22.00 **CLARIFICATION OF BIDS**

To assist in the examination, evaluation and comparison of Bids, the Purchaser may, at its discretion, ask the Bidder for a clarification of its Bid. All responses to requests for clarification shall be in writing and no change in the price or substance of the Bid shall be sought, offered or permitted.

### 23.00 **PRELIMINARY EXAMINATION OF BIDS/ RESPONSIVENESS**

23.01 Purchaser will examine the Bids to determine whether they are complete, whether any computational errors have been made, whether required sureties have been furnished, whether the documents have been properly signed, and whether the Bids are generally in order. Purchaser may ask for submission of original documents in order to verify the documents submitted in support of qualification criteria.

23.02 Arithmetical errors will be rectified on the following basis. If there is a discrepancy between the unit price and the total price per item that is obtained by multiplying the unit price and quantity, the unit price shall prevail and the total price per item will be corrected. If there is a discrepancy between the Total Amount and the sum of the total price per item, the sum of the total price per item shall prevail and the Total Amount will be corrected.

23.03 Prior to the detailed evaluation, Purchaser will determine the substantial responsiveness of each Bid to the Bidding Documents including production capability and acceptable quality of the Goods offered. A substantially responsive Bid is one, which conforms to all the terms and conditions of the Bidding Documents without material deviation.

23.04 Bid determined as not substantially responsive will be rejected by the purchaser and/or the Purchaser and may not subsequently be made responsive by the Bidder by correction of the non - conformity.

### 24.00 **EVALUATION AND COMPARISON OF BIDS**

The evaluation of Bids shall be done based on the delivered cost competitiveness basis.

24.01 The evaluation of the Bids shall be a stage-wise procedure. The following stages are identified for evaluation purposes: In the first stage, the Bids would be subjected to a responsiveness check. The Technical Proposals and the Conditional ties of the Bidders would be evaluated.

24.02 Subsequently, the Financial Proposals along with Supplementary Financial Proposals, if any, of Bidders with Techno-commercially Acceptable Bids shall be considered for final evaluation.

24.03 The Purchaser's evaluation of a Bid will take into account, in addition to the Bid price, the following factors, in the manner and to the extent indicated in this Clause:

- Delivery Schedule
- Conformance to Qualifying Criteria
- Deviations from Bidding Documents

Bidders shall base their Bid price on the terms and conditions specified in the Bidding Documents.

The cost of all quantifiable deviations and omissions from the specification, terms and conditions specified in Bidding Documents shall be evaluated. The Purchaser will make its own assessment of the cost of any deviation for the purpose of ensuring fair comparison of Bids.

24.04 Any adjustments in price, which result from the above procedures, shall be added for the purposes of comparative evaluation only to arrive at an "Evaluated Bid Price". Bid Prices quoted by Bidders shall remain unaltered.

#### 25.00 **CONTACTING THE PURCHASER**

25.01 If any Bidder wishes to contact the Purchaser on any matter related to the Bid, from the time of Bid opening to the time of contract award, the same shall be done in writing only.

25.02 Any effort by a Bidder to influence the Purchaser and/or in the Purchaser's decisions in respect of Bid evaluation, Bid comparison or Contract Award, will result in the rejection of the Bidder's Bid.

#### 26.00 **THE PURCHASER 'S RIGHT TO ACCEPT ANY BID AND TO REJECT ANY OR ALL BIDS**

Submission of bids shall not automatically constitute qualification for evaluation. The Purchaser reserves the right to accept or reject any Bid and to annul the Bidding process and reject all Bids at any time prior to award of Contract, without thereby incurring any liability to the affected Bidder or Bidders or any obligation to inform the affected Bidder or Bidders of the grounds for the Purchaser's action.

#### 27.00 **AWARD OF CONTRACT**

27.01 The Purchaser will award the Contract to the successful Bidder whose Bid has been determined to be the lowest-evaluated responsive Bid, provided further that the Bidder has been determined to be qualified to satisfactorily perform the Contract. Purchaser reserves the right to award order to other bidders in the tender, provided it is required for timely execution of project & provided he agrees to come to the lowest rate. Purchaser reserves the right to distribute the entire tender quantity at its own discretion without citing any reasons thereof.

#### **Splitting of tendered quantity among two or more bidders:**

BSES reserves the right to split the tender quantity among techno- commercially qualified bidders on account of delivery requirement in tender quantity under procurement.

For arranging timely procurement of material and to have uniform practice of distribution of quantity amongst eligible bidders, following procedure shall be applicable:

The tender quantity shall be split in following ratio:

- If the quantity is to be split among 2 bidders, it will be done in the ratio of 70:30 on L1 price.
- If the quantity is to be split among 3 bidders, it will be done in the ratio of 60:25:15 on L1 price.
- If the quantity is to be split among 4 bidders, it will be done in the ratio of 50:25:15:10 on L1 price.

Any deviation in regards to above will have deviation approval from management

**28.00 THE PURCHASER 'S RIGHT TO VARY QUANTITIES**

The Purchaser reserves the right to vary the quantity i.e. increase or decrease the numbers/quantities without any change in terms and conditions during the execution of the Order.

**29.00 LETTER OF INTENT/ NOTIFICATION OF AWARD**

The letter of intent/ Notification of Award shall be issued to the successful Bidder whose bids have been considered responsive, techno-commercially acceptable and evaluated to be the lowest (L1). The successful Bidder shall be required to furnish a letter of acceptance within 7 days of issue of the letter of intent /Notification of Award by Purchaser. The date of LOI/ PO shall be treated as Start date of work.

**30.00 PERFORMANCE BANK GAURANTEE**

To be submitted within fifteen (15) days from the date of issuance of the Letter of Award/RC, Supplier shall establish a performance bond in favour of BRPL in an amount not less than One percent (1%) of the total price of the Rate Contract (the "Performance Bond"). Bidder shall initially submit the PBG for 1% of RC Value valid till RC validity period plus one month.

Thereafter Bidder shall submit the performance bank guarantee equivalent to the 10% of the contract value with the validity of the bank guarantee for a period of 30 months from the date of last dispatch plus 3 months claim period. Upon submission of the performance security, the EMD shall be released.

**31.00 CORRUPT OR FRADULENT PRACTICES**

31.01 The Company requires that the Bidders observe the highest standard of ethics during the procurement and execution of the Project. In pursuance of this policy, the Company:

(a) Defines, for the purposes of this provision, the terms set forth below as follows:

"Corrupt practice" means behavior on the part of officials in the public or private sectors by which they improperly and unlawfully enrich themselves and/or those close to them, or induce others to do so, by misusing the position in which they are placed, and it includes the offering, giving, receiving, or soliciting of anything of value to influence the action of any such official in the procurement process or in contract execution; and

"Fraudulent practice" means a misrepresentation of facts in order to influence a award process or the execution of a contract to the detriment of the Company, and includes collusive practice among Bidders (prior to or after Bid submission) designed to establish Bid prices at artificial non -competitive levels and to deprive the Company of the benefits of free and open competition.

(b) Will reject a proposal for award if it determines that the Bidder recommended for award has engaged in corrupt or fraudulent practices in competing for the contract in question;

(c) Will declare a firm ineligible, either indefinitely or for a stated period of time, to be awarded a contract if it at any time determines that the firm has engaged in corrupt or fraudulent practices in competing for, or in executing, a contract.

31.02 Furthermore, Bidders shall be aware of the provision stated in the Terms and Conditions of Contract.

**32.00 COMPLETION PERIOD**

Within 90 Days Months from the date of PO

**SECTION III****GENERAL TERMS AND CONDITIONS - SUPPLY**

- 1.01** All the Bids shall be prepared and submitted in accordance with these instructions.
- 1.02** Bidder shall bear all costs associated with the preparation and delivery of its Bid, and the Purchaser will in no case shall be responsible or liable for these costs.
- 1.03** The Bid should be submitted by the Bidder in whose name the bid document has been issued and under no circumstances it shall be transferred/ sold to the other party.
- 1.04** The Purchaser reserves the right to request for any additional information and also reserves the right to reject the proposal of any Bidder, if in the opinion of the Purchaser, the data in support of RFQ requirement is incomplete.
- 1.05** The Bidder is expected to examine all instructions, forms, terms & conditions and specifications in the Bid Documents. Failure to furnish all information required in the Bid Documents or submission of a Bid not substantially responsive to the Bid Documents in every respect may result in rejection of the Bid. However, the Purchaser's decision in regard to the responsiveness and rejection of bids shall be final and binding without any obligation, financial or otherwise, on the Purchaser.

**2.0 DEFINITION OF TERMS**

- 2.01** "Purchaser" shall mean BSES Rajdhani Power Limited, on whose behalf this bid enquiry is issued by its authorized representative/ officers.
- 2.02** "Bidder" shall mean the firm who quotes against this bid enquiry issued by the Purchaser.
- 2.03** "Supplier" or "Supplier" shall mean the successful Bidder and/or Bidders whose bid has been accepted by the Purchaser and on whom the "Letter of Acceptance" is placed by the Purchaser and shall include his heirs, legal representatives, successors and permitted assigns wherever the context so admits.
- 2.04** "Supply" shall mean the Scope of Contract as described.
- 2.05** "Specification" shall mean collectively all the terms and stipulations contained in those portions of this bid document known as RFQ, Commercial Terms & Condition, Instructions to Bidders, Technical Specifications and the Amendments, Revisions, Deletions or Additions, as may be made by the Purchaser from time to time.
- 2.06** "Letter of Acceptance" shall mean the official notice issued by the Purchaser notifying the Supplier that his proposal has been accepted and it shall include amendments thereto, if any, issued by the Purchaser. The "Letter of Acceptance" issued by the Purchaser shall be binding on the "Supplier" The date of Letter of Acceptance shall be taken as the effective date of the commencement of contract.
- 2.07** "Month" shall mean the calendar month and "Day" shall mean the calendar day.
- 2.08** "Codes and Standards" shall mean all the applicable codes and standards as indicated in the Specification.
- 2.09** "Offer Sheet" shall mean Bidder's firm offer submitted to BRPL in accordance with the specification.
- 2.10** "Contract" shall mean the "Letter of Acceptance/Purchase Order" issued by the Purchaser.



- 2.11** "Contract Price" shall mean the price referred to in the "Letter of Acceptance/ Purchase Order".
- 2.12** "Contract Period" shall mean the period during which the "Contract" shall be executed as agreed between the Supplier and the Purchaser in the Contract inclusive of extended contract period for reason beyond the control of the Supplier and/or Purchaser due to force majeure.
- 2.13** "Acceptance" shall mean and deemed to include one or more of the following as will be stipulated in the specification:
- The written acceptance of material by the inspector at suppliers works to ship the materials.
  - Acceptance of material at Purchaser site/ stores after its receipt and due inspection/ testing and release of material acceptance voucher.
  - Where the scope of the contract includes supplying, acceptance shall mean issue of necessary equipment/ material takeover receipt after installation & commissioning and final acceptance.

### **3.0 CONTRACT DOCUMENTS & PRIORITY**

Contract Documents: The terms and conditions of the contract shall consist solely of these RFQ conditions and the offer sheet. The several documents forming the Contract are to be taken as mutually explanatory of one another, but in case of ambiguities or discrepancies, the same shall be explained and adjusted by the Purchaser, who shall thereupon issue to the Bidder, instructions thereon. In such event, unless otherwise provided in the Contract, the priority of the documents forming the Contract shall be as follows:

- Any amendments to Contract
- Commercial Terms & Conditions of the Contract
- Clarifications/addendum/corrigendum to Tender
- Terms & Conditions of the Tender

### **4.0 SCOPE OF SUPPLY - GENERAL**

- 4.01 The "Scope of Supply" shall be on the basis of Bidder's responsibility, completely covering the obligations, responsibility and supplies provided in this Bid enquiry whether implicit or explicit.
- 4.02 Bidder shall have to quote for the Bill of quantities as listed elsewhere.
- 4.03 All relevant drawings, data and instruction manuals.

### **5.0 QUALITY ASSURANCE AND INSPECTION**

- 5.01 Immediately on award of contract, the bidder shall prepare detailed quality assurance plan/ test procedure identifying the various stages of manufacture, quality checks performed at each stage, raw material inspection and the Customer hold points. The document shall also furnish details of method of checking, inspection and acceptance standards/values and get the approval of Purchaser before proceeding with manufacturing. However, Purchaser shall have right to review the inspection reports, quality checks and results of suppliers in house inspection department which are not Customer hold points and the supplier shall comply with the remarks made by purchaser or his representative on such reviews with regards to further testing, rectification or rejection, etc. In case of standard items, BRPL shall forward the standard QAP which is to be followed by vendor during manufacturing.
- 5.02 Witness and Hold points are critical steps in manufacturing, inspection and testing where the supplier is obliged to notify the Purchaser in advance so that it may be witnessed by the Purchaser. Final inspection is a mandatory hold point. The supplier can proceed with the work past a hold point only after clearance by purchaser or a witness waiver letter from BRPL.
- 5.03 The performance of waiver of QA activity by Purchaser at any stage of manufacturing does not relieve the supplier of any obligation to perform in accordance with and meet all the requirements of the procurement documents and also



all the codes & reference documents mentioned in the procurement document nor shall it preclude subsequent rejection by the purchaser.

- 5.04 On completion of manufacturing the items can only be dispatched after receipt of dispatch instructions issued by the Purchaser.
- 5.05 All in-house testing and inspection shall be done without any extra cost. The in-house inspection shall be carried out in presence of BRPL/ BRPL authorized third party inspection agency. Cost of Futile/ abortive visit(s) shall be debited from the invoices
- 5.06 Purchaser reserves the right to send any material being supplied to any recognized laboratory for testing, wherever necessary and the cost of testing shall be borne by the Bidder. In case the material is found not in order with the technical requirement/ specification, the charges along with any other penalty which may be levied is to be borne by the bidder. To avoid any complaint the supplier is advised to send his representative to the stores to see that the material sent for testing is being sealed in the presence of bidder's representative.

## **6.0 PACKING, PACKING LIST & MARKING**

- 6.01 **Packing:** Supplier shall pack or shall cause to be packed all Commodities in crates/ boxes/ drums/ containers/ cartons and otherwise in such a manner as shall be reasonably suitable for shipment by road or rail to BRPL, Delhi/ New Delhi stores/ site without undue risk of damage in transit.
- 6.02 **Packing List:** The contents of each package shall be itemized on a detailed list showing the exact weight, extreme outside dimensions (length, width & weight) of each container/ box/ drum/ carton, Item SAP Code, PO No & date. One copy of the packing list shall be enclosed in each package delivered.

## **7.0 PRICE BASIS FOR SUPPLY OF MATERIALS**

Bidder to quote their prices on Landed Cost Basis and separate price for each item, FIRM prices for supply to BRPL Delhi/New Delhi stores inclusive of packing, forwarding, loading at manufacturer's premises, payment of all taxes, GST, Freight, any other local charges etc.

The above supply prices shall also include unloading at BRPL Delhi/ New Delhi stores/ site.

Transit insurance will be arranged by Purchaser; however bidder to furnish required details in advance for arranging the same by Purchaser.

## **8.0 TERMS OF PAYMENT AND BILLING**

100% payment shall be made within 45 days from the date of receipt of material at store/ site Bidder to submit the following documents against dispatch of each consignment:

- i. Consignee copy of LR
- ii. Detailed invoice showing commodity description, qty, unit & total price and basis of delivery.
- iii. Original certificate issued by BRPL confirming receipt of material at site & acceptance
- iv. Dispatch clearance & inspection report issued by the inspection authority
- v. Packing List, Test Reports
- vi. Guarantee Certificate.

## **9.0 PRICE VALIDITY**

All bids submitted shall remain valid, firm and subject to unconditional acceptance by BRPL Delhi for 120 days from the due date of submission & subsequent corrigendum/ amendment/ extension of due date of submission. For awarded

suppliers/ Bidders, the prices shall remain valid and firm till contract completion.

## **10.0 PERFORMANCE GUARANTEE**

10.01 Bank guarantee shall be drawn in favour of "BSES Rajdhani Power Ltd" as applicable. The performance Bank guarantee shall be in the format as specified by BRPL.

10.02 To be submitted within fifteen (15) days from the date of issuance of the Letter of Award/RC, Supplier shall establish a performance bond in favour of BRPL in an amount not less than One percent (1%) of the total price of the Rate Contract (the "Performance Bond"). Bidder shall initially submit the PBG for 1% of RC Value valid till RC validity period plus one month.

Thereafter Bidder shall submit the performance bank guarantee equivalent to the 10% of the contract value with the validity of the bank guarantee for a period of 30 months from the date of last dispatch plus 3 months claim period. Upon submission of the performance security, the EMD shall be released.

10.03 Notwithstanding anything stated in this agreement, It is agreed by the Seller that in case of default by the seller in furnishing the Performance Bank Guarantee, the purchaser/ BRPL, without prejudice to the rights available with the purchaser, shall be entitled to retain a total sum not exceeding 120% of the amount of required performance bank guarantee for the tenure and upon the terms as specified in this agreement. It is agreed that the purchaser shall not be paying any interest for the said sum retained by the purchaser in lieu of default by the seller in furnishing the performance bank guarantee and no claim of any nature shall be maintainable from the side of seller, disputing the above said retention. Whereas, in case, after the deduction of above sum by the purchaser, if the seller at any point of time, submits the PBG of the required value and tenure and requests for the refund of the amount retained on this ground, the purchaser shall be releasing the money retained in lieu of PBG without any interest/ cost.

## **11.0 FORFEITURE**

11.01 Each Performance Bond established under Clause 10.0 shall contain a statement that it shall be automatically and unconditionally forfeited without recourse and payable against the presentation by BRPL of this Performance Bond, to the relevant bank referred to above, together with a simple statement that supplier has failed to comply with any term or condition set forth in the Contract.

11.02 Each Performance BG established under will be automatically and unconditionally forfeited without recourse if BRPL at its sole discretion determines that supplier has failed to comply with any term or condition set forth in the contract.

## **12.0 RELEASE**

All Performance Bonds will be released without interest within seven (7) days from the last date up to which the Performance Bond has to be kept valid (as defined in Clause 10.0) except for the case set forth in Clause 21.0.

## **13.0 GUARANTEE OF PERFORMANCE**

The bidder shall stand guarantee that the equipment and material supplied/ service or work rendered under the contract is free from design, manufacturing, material, construction, erection & installation and workmanship & quality defects and is capable of its due, rated and intended quality performance, as an integrated product delivered under

the contract for a specific period termed as Guarantee Period. The bidder should also guarantee that the equipment/ material is new and unused except for the usage required for the tests and checks required as part of quality assurance.

#### **14.0 GUARANTEE PERIOD/ DEFECTS LIABILITY PERIOD**

The bidder to guarantee the materials/ items supplied against any defect of failure, which arise due to faulty materials, workmanship or design for the entire defects liability period. The Defect liability period shall be 60 months from the date of commissioning or 66 months from the date of delivery whichever is earlier.

If during the defects liability period any materials/ items are found to be defective, these shall be replaced or rectified by the bidder at his own cost within 30 days from the date of receipt of intimation.

##### **Cost of repairs on failure in Guarantee Period:**

The cost of repairs/ rectification / replacement, apart from the actual cost of repairs/ rectification/ replacement is also inclusive of all bidder costs of required transportation, site inspection/ mobilization/ dismantling and re-installation costs as applicable, to be borne by the bidder. The bidder has to ensure that the interruption in the usage of intended purpose of the equipment is minimized to the maximum extent in lieu of the time taken for repairs/rectification/ replacement.

#### **15.0 RETURN, REPLACEMENT OR SUBSTITUTION**

BRPL shall give Supplier notice of any defective Commodity promptly after becoming aware thereof. BRPL may at its discretion elect to return defective Commodities to Supplier for replacement, free of charge to BRPL, or may reject such Commodities and purchase the same or similar Commodities from any third party. In the latter case BRPL shall furnish proof to Supplier of the cost of such substitute purchase. In either case, all costs of any replacement, substitution, shipping, labour and other related expenses incurred in connection with the return and replacement or for the substitute purchase of a Commodity hereunder should be for the account of Supplier. BRPL may set off such costs against any amounts payable by BRPL to Supplier. Supplier shall reimburse BRPL for the amount, if any, by which the price of a substitute Commodity exceeds the price for such Commodity as quoted in the Bid.

#### **16.0 EFFECTIVE DATE OF COMMENCEMENT OF CONTRACT**

The date of the issuance of the Letter of Acceptance/ Purchase Order shall be treated as the effective date of the commencement of Contract.

#### **17.0 TIME – THE ESSENCE OF CONTRACT**

The time and the date of completion of the "Supply" as stipulated in the Letter Of Acceptance/ Purchase order issued to the Supplier shall be deemed to be the essence of the "Contract". The Supply has to be completed no later than the aforesaid Schedule and date of completion of supply.

#### **18.0 THE LAWS AND JURISDICTION OF CONTRACT**

Any dispute or difference arising out of this Purchase Order shall be discussed by the Purchaser and Supplier. Both shall endeavor to reach an amicable settlement within a period of fifteen (15) days. If an agreement could not be reached within this period then the dispute shall be referred to arbitration under the Indian Arbitration and Conciliation Act-1996, as may be amended from time to time. The venue of arbitration shall be Delhi.

The award shall be a reasoned award and shall be final and binding on both the parties and shall not be subjected to appeal. Subject to arbitration the Courts at Delhi shall have exclusive jurisdiction over all matters arising under this Purchase Order. During pendency of arbitration the parties shall continue to perform respective obligations under this Purchase Order.

**19.0 Events of Default**

- 21.01 Events of Default. Each of the following events or occurrences shall constitute an event of default ("Event of Default") under the Contract:
- (a) Supplier fails or refuses to pay any amounts due under the Contract;
  - (b) Supplier fails or refuses to deliver Commodities conforming to this RFQ/ specifications, or fails to deliver Commodities within the period specified in P.O. or any extension thereof
  - (c) Supplier becomes insolvent or unable to pay its debts when due, or commits any act of bankruptcy, such as filing any petition in any bankruptcy, winding-up or reorganization proceeding, or acknowledges in writing its insolvency or inability to pay its debts; or the Supplier's creditors file any petition relating to bankruptcy of Supplier;
  - (d) Supplier otherwise fails or refuses to perform or observe any term or condition of the Contract and such failure is not remediable or, if remediable, continues for a period of 30 days after receipt by the Supplier of notice of such failure from BRPL.

**20.0 CONSEQUENCES OF DEFAULT**

- (a) If an Event of Default shall occur and be continuing, BRPL may forthwith terminate the Contract by written notice.
- (b) In the event of an Event of Default, BRPL may, without prejudice to any other right granted to it by law, or the Contract, take any or all of the following actions;
  - (i) present to Bank for forfeiture to the relevant bank the Performance Bond;
  - (ii) Purchase the same or similar Commodities from any third party; and/or
  - (iii) Recover any losses and/or additional expenses BRPL may incur as a result of Supplier's default.

In the event COMPANY terminates the Supply order, in whole or in part, on the occurrence of any event of default, COMPANY reserves the right to engage any other Contractor or agency to complete the Supply or any part thereof, and in addition to any other right COMPANY may have under this Supply order or in law including without limitation the right to penalize for delay of this Supply order, the Supplier shall be liable to COMPANY for any additional costs that may be incurred by COMPANY for the execution of the Work.

**21.0 LIQUIDATED DAMAGES**

- 23.01 If supply of items/ equipment is delayed beyond the supply schedule as stipulated in LOI/ PO, then the Supplier shall be liable to pay the Purchaser for delay a sum of 1% (one percent) of the total price for every week of delay or part thereof for undelivered units.
- 23.02 The total amount for delay under the contract will be subject to a maximum of ten percent (10%) of the total contract value.
- 23.03 The Purchaser may, without prejudice to any method of recovery, deduct the amount for such damages from any amount due or which may become due to the Supplier or from the Performance Bond or file a claim against the supplier. The levy payment or deduction of such damages shall not relieve the Bidder from his obligation to complete the Supply on time or from any other part of his obligation and liabilities under the Contract. Once the maximum is reached, the Company reserves the right for termination of contract without any liabilities to the Company.

In the event of an extension of time being granted, in writing for the Completion of the works, this clause shall be applicable after the expiry of such an extended period.

**22.0 STATUTORY VARIATION IN TAXES AND DUTIES**

The total order value shall remain **FIRM** within stipulated delivery period and shall not be adjusted on account of any price increase/ variations in commodities & raw materials. Statutory Taxes, duties and Levies imposed by Competent Authorities by way of fresh notification(s) within the stipulated delivery period shall be borne by BRPL on submission of necessary documents claiming such variation. However, in case of reduction in taxes, duties and levies, the benefits

of the same shall be passed on to BUYER. The variation will be applicable only on such value wherever price breakup of same is submitted by vendor/available in PO/ WO.

## **23.0 FORCE MAJEURE**

### **23.01 General**

An "Event of Force Majeure" shall mean any event or circumstance not within the reasonable control directly or indirectly, of the Party affected, but only if and to the extent that:

- (i) Such event or circumstance materially and adversely affects the ability of the affected Party to perform its obligations under this Contract, and the affected Party has taken all reasonable precautions, due care and reasonable alternative measures in order to prevent or avoid the effect of such event on the affected party's ability to perform its obligations under this Contract and to mitigate the consequences thereof.
- (ii) For the avoidance of doubt, if such event or circumstance would not have materially and adversely affected the performance of the affected party had such affected party followed good industry practice, such event or circumstance shall not constitute force majeure.
- (iii) Such event is not the direct or indirect result of the failure of such Party to perform any of its obligations under this Contract.
- (iv) Such Party has given the other Party prompt notice describing such events, the effect thereof and the actions being taken in order to comply with above clause.

### **23.02 Specific Events of Force Majeure: Subject to the provisions of above clause, Events of Force Majeure shall include only the following to the extent that they or their consequences satisfy the above requirements:**

- (i) The following events and circumstances:
  - a) Effect of any natural element or other acts of God, including but not limited to storm, flood, earthquake, lightning, cyclone, landslides or other natural disasters.
  - b) Explosions or fires
    - (ii) War declared by the Government of India, provided that the ports at Mumbai are declared as a war zone.
    - (iii) Dangers of navigation, perils of the sea.

### **23.03 Notice of Events of Force Majeure: If a force majeure event prevents a party from performing any obligations under the Contract in part or in full that party shall:**

- i) Immediately notify the other party in writing of the force majeure events within 7(seven) working days of the occurrence of the force majeure event
- ii) Be entitled to suspend performance of the obligation under the Contract which is affected by force majeure event for the duration of the force majeure event.
- iii) Use all reasonable efforts to resume full performance of the obligation as soon as practicable
- iv) Keep the other party informed of all such efforts to resume full performance of the obligation on a regular basis.
- v) Provide prompt notice of the resumption of full performance or obligation to the other party.

### **23.04 Mitigation of Events of Force Majeure Each Party shall:**

- (i) Make all reasonable efforts to prevent and reduce to a minimum and mitigate the effect of any delay occasioned by an Event of Force Majeure including recourse to alternate methods of satisfying its obligations under the Contract;
- (ii) Use its best efforts to ensure resumption of normal performance after the termination of any Event of Force Majeure and shall perform its obligations to the maximum extent practicable as agreed between the Parties; and

- (iii) Keep the other Party informed at regular intervals of the circumstances concerning the event of Force Majeure, with best estimates as to its likely continuation and what measures or contingency planning it is taking to mitigate and or terminate the Event of Force Majeure.
- 23.05 Burden of Proof: In the event that the Parties are unable in good faith to agree that a Force Majeure event has occurred to an affected party, the parties shall resolve their dispute in accordance with the provisions of this Agreement. The burden of proof as to whether or not a force Majeure event has occurred shall be upon the party claiming that the force majeure event has occurred and that it is the affected party.
- 23.06 Termination for Certain Events of Force Majeure: If any obligation of any Party under the Contract is or is reasonably expected to be delayed or prevented by a Force Majeure event for a continuous period of more than 3 months, the Parties shall promptly discuss in good faith how to proceed with a view to reaching a solution on mutually agreed basis. If a solution on mutually agreed basis cannot be arrived at within a period of 30 days after the expiry of the period of three months, the Contract shall be terminated after the said period of 30 days and neither Party shall be liable to the other for any consequences arising on account of such termination.
- 23.07 The Purchaser may terminate the contract after giving 7(seven) days notice if any of following occurs:
- Bidder fails to complete execution of works within the approved schedule of works, terms and conditions
  - In case the Bidder commits any Act of Insolvency, or adjudged insolvent
  - Has abandoned the contract
  - Has failed to commence work or has suspended the progress of works
  - Has failed to proceed the works with due diligence and failed to make such due progress
- 23.08 Limitation of Force Majeure event: The Supplier shall not be relieved of any obligation under the Contract solely because cost of performance is increased, whether as a consequence of adverse economic consequences or otherwise.
- 23.09 Extension of Contract Period due to Force Majeure event: The Contract period may be extended by mutual agreement of Parties by way of an adjustment on account of any period during which an obligation of either Party is suspended due to a Force Majeure event.
- 23.10 Effect of Events of Force Majeure: Except as otherwise provided herein or may further be agreed between the Parties, either Party shall be excused from performance and neither Party shall be construed to be in default in respect of any obligations hereunder, for so long as failure to perform such obligations shall be due to an event of Force Majeure."

#### **24.0 TRANSFER AND SUB-LETTING**

The Supplier shall not sublet, transfer, assign or otherwise part with the Contract or any part thereof, either directly or indirectly, without prior written permission of the Purchaser.

#### **25.0 RECOVERIES**

Whenever under this contract any money is recoverable from and payable by the bidder, the purchaser shall be entitled to recover such sum by appropriating in part or in whole by deducting any sum due to which any time thereafter may become due from the supplier in this or any other contract. Should the sum be not sufficient to cover the full amount recoverable, the bidder shall pay to the purchaser on demand the remaining balance.

#### **26.0 WAIVER**

Failure to enforce any condition herein contained shall not operate as a waiver of the condition itself or any subsequent breach thereof.

#### **27.0 INDEMNIFICATION**

Notwithstanding contrary to anything contained in this RFQ, Supplier shall at his costs and risks make good any loss or damage to the property of the Purchaser and/or the other Supplier engaged by the Purchaser and/or the employees



of the Purchaser and/or employees of the other Supplier engaged by the Purchaser whatsoever arising out of the negligence of the Supplier while performing the obligations under this contract.

## **28.0 TERMINATION**

The Supplier hereby undertakes to fully comply and conform to the terms and conditions of this Order. In the event of failure to do so, Purchaser shall have the right to terminate the assignment and claim damages. The upper limit for the damages will be the value of equivalent material/ services, which are available from Third parties.

Should unforeseen conditions arise and the Purchaser deems it necessary, to suspend indefinitely or abandon the supplies, the purchase order may be terminated by Purchaser after having given 10 days notice in writing. In the event of such termination, the Supplier shall be entitled to be paid the amount due for the supplies rendered and/or expenses incurred up to the date of such termination. Any such compensation being claimed shall be substantiated by the Supplier. The upper limit for the compensation being claimed shall be the value of the Purchase order.

## **29.0 TERMINATION BY EMPLOYER FOR CONVENIENCE**

The Employer shall, in addition to any other right enabling it to terminate the Contract, have the right to terminate the Contract at any time by giving a written notice to the Contractor. The Contract shall stand terminated on receipt of such notice but such termination shall be without prejudice to the rights of the Parties accrued on and before the date of termination.

## **30.0 LIMITATION ON LIABILITY**

Notwithstanding anything to the contrary in the Purchase Order but subject to clause 31.0 Consequential Damages, the aggregate liability of either Party to the other Party in respect of all claims for Liabilities arising under the Purchase Order shall not exceed the aggregate value of the Purchase Order(s) under which the Liabilities arose except that such limitation shall not apply to the Bidder's indemnification obligations in accordance with clause 27.0 Indemnification herein.

## **31.0 CONSEQUENTIAL DAMAGES**

Notwithstanding anything to the contrary in the Purchase Order, except for breach of obligations under Non-disclosure and except as expressly provided in a Purchase Order, in no event, as a result of breach of contract or breach of warranty or otherwise, shall either Party hereto or either Party's Affiliates or sub Bidders, be liable under the Purchase Order to the other Party for any consequential, special, indirect, exemplary or incidental damages, and/or for any lost profits, goodwill or revenues of such Party, howsoever arising, before or after Acceptance of the Goods and whether or not such damages are foreseeable.

## **32.0 RISK & COST**

If the Bidder fails to supply the items as per specification within the scheduled period and even after the extended period, the contract shall get cancel and company reserves the right to get the material supplied from any other source at the Risk & Cost of the Bidder. The Extra Expenditure so incurred shall be debited to the Bidder.

## **33.0 NON-DISCLOSURE AGREEMENT**

All information including, without limitation, all oral and written information, disclosed by either party (Disclosing Party) to the other party, (Receiving Party) is deemed to be confidential, restricted and proprietary to the Disclosing Party.

**Non-Disclosure:** The Receiving Party shall maintain the Confidential Information received from the Disclosing Party in strict confidence and shall not disclose it to any third party without the prior written consent of the Disclosing Party.

**Limited Use:** The Receiving Party shall use the Confidential Information solely for the Purpose outlined in this Agreement and shall not use it for any other purpose without the prior written consent of the Disclosing Party.

**Protection Measures:** The Receiving Party shall exercise reasonable care to protect the Confidential Information from unauthorized access, use, or disclosure. This includes implementing appropriate security measures and restricting access to the Confidential Information to only those individuals who have a need to know for the Purpose.

**Exceptions:** The obligations of confidentiality shall not apply to any portion of the Confidential Information that:

- a. Is or becomes publicly available through no fault of the Receiving Party;
- b. Was already lawfully in the possession of the Receiving Party prior to its disclosure by the Disclosing Party;
- c. Is rightfully received by the Receiving Party from a third party without any obligation of confidentiality; or
- d. Is required to be disclosed by law, regulation, or court order. However, the Receiving Party shall promptly notify the Disclosing Party of any such requirement and cooperate with the Disclosing Party to seek a protective order or other appropriate remedy.

Upon the written request of the Disclosing Party or upon termination of this Agreement, whichever occurs first, the Receiving Party shall promptly return or destroy all Confidential Information received from the Disclosing Party, including any copies, notes, or extracts thereof, and provide written certification of such return or destruction upon request.

The obligations of confidentiality shall survive the termination or expiration of this Agreement and shall continue for a period of five years from the date of termination or expiration.



**SECTION – IV**  
**QUANTITY AND DELIVERY REQUIREMENT**

S.No	Item Description	Specification	Requirement		Location
			Qty.	Delivery Schedule	
<b>BSES RAJDHANI POWER LIMITED</b>					
1	SUPPLY OF 11KV GRADE ALUMINIUM CONDUCTOR POWER CABLE OF SIZE 11KV 3Cx400 SQ.MM CCD- CABLE IN CO-EXTRUDED DUCT.	BSES-TS-15-HTC-R0	320 Kms	Within <b>90 Days</b> from the date of PO	New Delhi Stores

**SECTION - V****PRICE FORMAT – SUPPLY**

<b>S. No.</b>	<b>Item Description</b>	<b>Qty</b>	<b>UOM</b>	<b>Basic (Rs)</b>	<b>Freight (Rs)</b>	<b>GST (Rs)</b>	<b>Unit Landed (Rs)</b>	<b>Total Landed Cost (Rs)</b>
1	RATE CONTRACT FOR SUPPLY OF 11KV GRADE ALUMINIUM CONDUCTOR POWER CABLE OF SIZE 11KV 3Cx400 SQ.MM CCD- CABLE IN CO-EXTRUDED DUCT.	320	Kms					

**APPENDIX - I****COMMERCIAL TERMS AND CONDITIONS - SUPPLY**

<b>S. No</b>	<b>Item Description</b>	<b>AS PER BRPL</b>	<b>BIDDER'S CONFIRMATION</b>
1	Validity	120 days from the due date of submission or amended due date of submission	
2	Price basis	<b>"Firm"</b> , FOR Delhi store basis. Prices shall be inclusive of all taxes & duties, freight up to Delhi stores. Unloading at stores shall be in vendor's scope	
3	Payment terms	100% payment within 45 days after receipt of material at stores	
4	Completion time	Within 90 Days from the date of PO	
5	Defect Liability period	60 months after commissioning or 66 months from the last date of dispatch, whichever is earlier	
6	Liquidated damages	1% per week of delay of undelivered units or part thereof subject to maximum of 10% of total PO value of undelivered units	
7	Performance Bank Guarantee	To be submitted within fifteen (15) days from the date of issuance of the Letter of Award/RC, Supplier shall establish a performance bond in favour of BRPL in an amount not less than One percent (1%) of the total price of the Rate Contract (the "Performance Bond"). Bidder shall initially submit the PBG for 1% of RC Value valid till RC validity period plus one month. Thereafter Bidder shall submit the performance bank guarantee equivalent to the 10% of the contract value with the validity of the bank guarantee for a period of 30 months from the date of last dispatch plus 3 months claim period	

**APPENDIX - II****BID FORM**

To

Head of Department  
 Contracts & Material Deptt.  
 BSES Rajdhani Power Ltd  
 New Delhi 110019

Sir,

1. We understand that BRPL is desirous of execution of .....(Name of work)
2. Having examined the Bidding Documents for the above named works, we the undersigned, offer to deliver the goods in full conformity with the Terms and Conditions and technical specifications for the sum indicated in Price Bid or such other sums as may be determined in accordance with the terms and conditions of the contract .The above amounts are in accordance with the Price Schedules attached herewith and are made part of this bid.
3. If our Bid is accepted, we undertake to deliver the entire goods as per delivery schedule mentioned in Section IV from the date of award of purchase order/letter of intent.
4. If our Bid is accepted, we will furnish a performance bank guarantee for an amount of 10% (Ten)percent of the total contract value for due performance of the Contract in accordance with the Terms and Conditions.
5. We agree to abide by this Bid for a period of 120 days from the due date of bid submission & subsequent corrigendum/amendment/extension of due date of submission. It shall remain binding upon us and may be accepted at any time before the expiration of that period.
6. We declare that we have studied the provision of Indian Laws for supply of equipments/materials and the prices have been quoted accordingly.
7. Unless and until Letter of Intent is issued, this Bid, together with your written acceptance thereof, shall constitute a binding contract between us.
8. We understand that you are not bound to accept the lowest, or any bid you may receive.
9. There is provision for Resolution of Disputes under this Contract, in accordance with the Laws and Jurisdiction of Contract.

Dated this..... day of..... 20.....

Signature..... In the capacity of

.....duly authorized to sign for

and on behalf of

(IN BLOCK CAPITALS).....

**Appendix - III****ACCEPTANCE FORM FOR PARTICIPATION IN REVERSE AUCTION EVENT**

(To be signed & stamped by the bidder along-with bid)

BSES Rajdhani Power Ltd (BRPL) intends to use reverse auction through SAP-SRM tool as an integral part of entire tendering process. All techno-commercially qualified bidders shall participate in the reverse auction.

The following terms and conditions are deemed as accepted by the bidder on participation in the bid:-

1. In case of bidding through Internet medium, bidders are advised to ensure availability of all associated infrastructure as required for participating in the reverse auction event. Inability to bid due to telephone glitch, internet response issues, software & hardware hangs/failures, power failures or any other reason shall not be the responsibility of BRPL.
2. In case bidder fails to participate in the reverse auction event due to any reason whatsoever, it shall be presumed that the bidder has no further discounts to offer and the initial bid submitted by them as a part of tender shall be considered as bidder's Final No Regret offer. Any off-line price bids received from a bidder in lieu of non-participation in the reverse auction event shall be rejected by BRPL.
3. The bidder is advised to understand the bid process to safeguard them against any possibility of non-participation in the reverse auction event.
4. The bidder shall be prepared with competitive price quotes during the day of reverse auction event.
5. The prices quoted by bidder in reverse auction event shall be on FOR Landed cost BRPL Store/site basis inclusive of all relevant taxes, duties, levies, transportation charges etc.
6. The prices submitted by the bidder during reverse auction event shall be binding on the Bidder.
7. The bidder agrees to non-disclosure of trade information regarding bid details e.g. purchase, Identity, bid process/technology, bid documentation etc.
8. BRPL will make every effort to make the bid process transparent. However award decision of BRPL will be final and binding on the bidder.
9. The prices submitted during reverse auction event shall be binding on the bidder.
10. No request for Time extension of the reverse auction event shall be considered by BRPL.
11. BRPL shall provide the user id and password to the authorized representative of the bidder. Authorization letter in lieu of the same shall be submitted along with the signed and stamped acceptance form.
12. The original price bids of the bidders shall be reduced on pro-rata basis against each line item based on the final all inclusive prices offered during conclusion of the reverse auction event for arriving at contract amount

**APPENDIX - IV****FORMAT FOR EMD BANK GUARANTEE**

*(To be issued in a Non Judicial Stamp Paper of Rs.50/-purchased in the name of the bank)*

Whereas [*name of the Bidder*] (herein after called the "Bidder") has submitted its bid dated [*date of submission of bid*] for the supply of [*name and/or description of the goods*] (here after called the "Bid").

KNOW ALL PEOPLE by these presents that WE [*name of bank*] at [*Branch Name and address*],having our registered office at[*address of the registered office of the bank*](herein after called the "Bank"),are bound unto BSES Rajdhani Power Ltd., with its Corporate Office at BSES Bhawan Nehru Place, New Delhi -110019 ,(herein after called —the "Purchaser")in the sum of Rs. ....../- (Rupees ..... only) for which payment well and truly to be made to the said Purchaser, the Bank binds itself, its successors, and assigns by these presents.

Sealed with the Common Seal of the said Bank this\_\_\_\_\_ day of\_\_\_\_\_ 20\_\_\_\_\_.

THE CONDITIONS of this obligation are:

1. If the Bidder withdraws its Bid during the period of bid validity specified by the Bidder on the Bid Form ; or
1. If the Bidder, having been notified of the acceptance of its Bid by the Purchaser during the period of bid validity:
  - I. Fails or refuses to execute the Contract Form, if required; or
  - II. Fails or refuses to furnish the performance security, in accordance with the instructions to Bidders/ Terms and Conditions;

We undertake to pay to the Purchaser up to the above amount upon receipt of its first written demand, without the Purchaser having to substantiate its demand, provided that is its demand the purchaser will note that amount claimed by it is due to it, owing to the occurrence of one or both of the two condition(s), specifying the occurred condition or condition(s).

This guarantee will remain in force up to and including One Hundred Twenty (120) days after the due date of submission bid, and any demand in respect thereof should reach the Bank not later than the above date.

(Stamp & signature of the bank)

Signature of the witness

**APPENDIX - V****FINANCIAL DATA**

(Duly Certified by Chartered Accountant)

	<b>FY 2021-22</b>	<b>FY 2022-23</b>	<b>FY 2023-24</b>
Total assets			
Current assets			
Total Liability			
Current Liability			
Profit before taxes			
Profit after taxes			
Sales Turnover			

**APPENDIX - VI****FORMAT FOR BACKUP OF SUPPLY & PERFORMANCE QUANTITY**

<b>S.No</b>	<b>PO No</b>	<b>PO Date</b>	<b>PO Qty</b>	<b>Supplied</b>		<b>Customer</b>	<b>F.Y</b>
				Qty.	Date		

**APPENDIX - VII****NO DEVIATION SHEET**

<b>SL NO</b>	<b>SL NO OF TECHNICALSPECIFICATION</b>	<b>DEVIATIONS,IF ANY</b>

**SIGNATURE & SEAL OF BIDDER****NAME OF BIDDER**



**APPENDIX - VIII****CHECK LIST**

<b>SI No</b>	<b>Description</b>	<b>Compliance</b>
1	INDEX	YES/NO
2	COVERING LETTER	YES/NO
3	BID FORM (UNPRICED) DULY SIGNED	YES/NO
4	BILL OF MATERIAL (UNPRICED)	YES/NO
5	DOCUMENTS IN SUPPORT OF QUALIFICATION CRITERIA	YES/NO
6	TECHNICAL BID	YES/NO
7	ACCEPTANCE TO COMMERCIAL TERMS AND CONDITIONS	YES/NO
8	FINANCIAL BID (IN SEALED ENVELOPE)	YES/NO
9	EMD IN PRESCRIBED FORMAT	YES/NO
10	DEMAND DRAFT OF RS 1000/- DRAWN IN FAVOUR OF BSES RAJDHANI POWER LTD	YES/NO
11	POWER OF ATTORNEY/AUTHORISATION LETTER FOR SIGNING THE BID	YES/NO
12	FINANCIAL DATA IN TABULAR FORMAT	YES/NO
13	LIST OF SUPPLY & PERFORMANCE QUANTITY	YES/NO
14	BANK SOLVENCY CERTIFICATE	YES/NO
15	NO LITIGATION CERTIFICATE	YES/NO

Note : The above documents must be properly tagged with page nos.

**APPENDIX - IX****FORMAT FOR PERFORMANCE BANK GUARANTEE**

(TO BE ISSUED ON RS 100/- STAMP PAPER)

Bank Guarantee No.

Place:

Date:

To  
BSES Rajdhani Power Limited

Whereas BSES RAJDHANI POWER LTD (hereinafter referred to as the "Purchaser", which expression shall unless repugnant to the context or meaning thereof include its successors, administrators and assigns) has awarded to M/s. with its Registered/ Head Office at

(Hereinafter referred to as the "Supplier" which expression shall unless repugnant to the context or meaning thereof, include its successors administrators, executors and assigns), a contract no. Dated (the Contract);

And whereas the value of the Contract is Rs. (The Contract Value).

And whereas it is a condition of the Contract that the Supplier shall provide a Performance Bank Guarantee for the due and faithful performance of the entire Contract for a sum equivalent to - % of the Contract Value to the Purchaser on or before

And whereas the Bank under instructions from the Supplier has agreed to guarantee due performance of the Contract. Now it is agreed as follows:

1. We (Name of the Bank) having its Head Office at (hereinafter referred to as the Bank, which expression shall unless repugnant to the context or meaning thereof, include its successors, administrators, executors and assigns) shall indemnify and keep indemnified the Purchaser for, and guarantee and undertake to pay to the Purchaser immediately on written demand, a sum equivalent to % of the Contract Value as aforesaid at any time up to (day/month/year) without any demur, reservation, contest, recourse or protest and/or without any reference to the Supplier, against all losses, damages, costs and expenses that may be caused to or suffered by the Purchaser by reason of any default on the part of the Supplier in performing and observing any and all the terms and conditions of the Contract or breach on the part of the Supplier of terms or conditions of the Contract.
2. The demand shall consist only of an original letter issued by Purchaser stating that the Supplier has failed to fulfill its obligations under the Contract. Such demand made by the Purchaser on the Bank shall be conclusive and binding notwithstanding any difference or dispute between the Purchaser and the Supplier or any difference or dispute pending before any Court, Tribunal, Arbitrator or any other authority.
3. The Bank undertakes not to revoke this guarantee during its currency without previous written consent of the Purchaser and further agrees that the guarantee herein contained shall continue to be enforceable during the period that would be taken for satisfactory performance and fulfillment in all respects of the Contract or in the event of

any dispute between the Purchaser and Supplier until the dispute is settled (provided that due claim demand under this guarantee is lodged /referred during the currency of this guarantee) or till the Purchaser discharges this guarantee whichever is earlier.

4. The Purchaser shall have the fullest liberty without affecting in any way the liability of the Bank under this guarantee from time to time to extend the time for performance of the Contract by the Supplier. The Purchaser shall have the fullest liberty, without affecting the liability of the Bank under this guarantee, to postpone from time to time the exercise of any powers vested in them or of any right which they might have against the Supplier, and to exercise the same at any time in any manner, and either to enforce or to forbear to enforce any covenants, contained or implied, in the Contract or any other course or remedy or security available to the Purchaser. The Bank shall not be released of its obligations under these presents by any exercise by the Purchaser of its liberty with reference: to the matters aforesaid or any of them or by reason of any other act or forbearance or other acts of omission or commission on the part of the Purchaser or any other indulgence shown by the Purchaser of by any other matter or thing whatsoever which under law would, but for this provision, have the effect of relieving the Bank.
5. The Bank agrees that the Purchaser and its option shall be entitled to enforce this guarantee against the Bank as a principal debtor, in the first instance without proceeding against the Supplier and notwithstanding any security or other guarantee that the Purchaser may have in relation to the Supplier's liabilities.
6. Notwithstanding anything contained hereinabove the liability of the Bank under this guarantee is restricted to a sum equivalent to % of the Contract Value i.e. Rs.(Rupees) and it shall remain in force up to and including .Unless a demand to enforce a claim under this guarantee is made against the Bank within 3 months from the above date of expiry i.e. up to all the rights of the Purchaser under the said guarantee shall be forfeited and the Bank shall be released and discharged from all liabilities thereafter.
7. This Performance Bank Guarantee shall be governed by the laws of India.

Dated this Witness

day of 20..... at

1. For Bank

2. Signature  
Name Power of Attorney No:

Banker's Seal

## **SECTION VI**

### **VENDOR CODE OF CONDUCT**

Bidder shall agree to comply with Vendor code of Conduct as mentioned in BRPL Website. Purchaser is committed to conducting its business in an ethical, legal and socially responsible manner. To encourage compliance with all legal requirements and ethical business practices, Purchaser has established this Vendor Code of Conduct (the "Code") for Vendors. For the purposes of this document, "Vendor" means any company, corporation or other entity that sells, or seeks to sell goods or services, to Purchaser, including the Vendor's employees, agents and other representatives. Fundamental to adopting the Code is the understanding that a business, in all of its activities, must operate in full compliance with the laws, rules and regulations of the countries in which it operates. This Code encourages Vendors to go beyond legal compliance, drawing upon internationally recognized standards, in order to advance social and environmental responsibility.

#### **I. Labour and Human Rights**

Vendors must uphold the human rights of workers, and treat them with dignity and respect as understood by the international community.

- Fair Treatment - Vendors must be committed to a workplace free of harassment. Vendors shall not threaten workers with or subject them to harsh or inhumane treatment, including sexual harassment, sexual abuse, corporal punishment, mental coercion, physical coercion, verbal abuse or unreasonable restrictions on entering or exiting company provided facilities.
- Antidiscrimination - Vendors shall not discriminate against any worker based on race, colour, age, gender, sexual orientation, ethnicity, disability, religion, political affiliation, union membership, national origin, or marital status in hiring and employment practices such as applications for employment, promotions, rewards, access to training, job assignments, wages, benefits, discipline, and termination. Vendors shall not require a pregnancy test or discriminate against pregnant workers except where required by applicable laws or regulations or prudent for workplace safety. In addition, Vendors shall not require workers or potential workers to undergo medical tests that could be used in a discriminatory way except where required by applicable law or regulation or prudent for workplace safety.
- Freely Chosen Employment - Forced, bonded or indentured labour or involuntary prison labour is not to be used. All work will be voluntary, and workers should be free to leave upon reasonable notice. Workers shall not be required to hand over government-issued identification, passports or work permits as a condition of employment.
- Prevention of Under Age Labour - Child labour is strictly prohibited. Vendors shall not employ children. The minimum age for employment or work shall be 15 years of age, the minimum age for employment in that country, or the age for completing compulsory education in that country, whichever is higher. This Code does not prohibit participation in legitimate workplace apprenticeship programs that are consistent with Article 6 of ILO Minimum Age Convention No. 138 or light work consistent with Article 7 of ILO Minimum Age Convention No. 138.

- Juvenile Labour - Vendors may employ juveniles who are older than the applicable legal minimum age for employment but are younger than 18 years of age, provided they do not perform work likely to jeopardize their health, safety, or morals, consistent with ILO Minimum Age Convention No. 138.
- Minimum Wages - Compensation paid to workers shall comply with all applicable wage laws, including those relating to minimum wages, overtime hours and legally mandated benefits. Any disciplinary wage deductions are to conform to local law. The basis on which workers are being paid is to be clearly conveyed to them in a timely manner.
- Working Hours - Studies of good manufacturing practices clearly link worker strain to reduced productivity, increased turnover and increased injury and illness. Work weeks are not to exceed the maximum set by local law. Further, a work week should not be more than 60 hours per week, including overtime, except in emergency or unusual situations. Workers should be allowed at least one day off per seven-day week.
- Freedom of Association - Open communication and direct engagement between workers and management are the most effective ways to resolve workplace and compensation issues. Vendors are to respect the rights of workers to associate freely and to communicate openly with management regarding working conditions without fear of reprisal, intimidation or harassment. Workers' rights to join labour unions seek representation and or join worker's councils in accordance with local laws should be acknowledged.

II. Health and Safety Vendors must recognize that in addition to minimizing the incidence of work-related injury and illness, a safe and healthy work environment enhances the quality of products and services, consistency of production and worker retention and morale. Vendors must also recognize that ongoing worker input and education is essential to identifying and solving health and safety issues in the workplace.

III. The health and safety standards are:

- Occupational Injury and Illness - Procedures and systems are to be in place to prevent, manage, track and report occupational injury and illness, including provisions to: a) encourage worker reporting; b) classify and record injury and illness cases; c) provide necessary medical treatment; d) investigate cases and implement corrective actions to eliminate their causes; and e) facilitate return of workers to work.
- Emergency Preparedness - Emergency situations and events are to be identified and assessed, and their impact minimized by implementing emergency plans and response procedures, including: emergency reporting, employee notification and evacuation procedures, worker training and drills, appropriate fire detection and suppression equipment, adequate exit facilities and recovery plans.
- Occupational Safety - Worker exposure to potential safety hazards (e.g., electrical and other energy sources, fire, vehicles, and fall hazards) are to be controlled through proper design, engineering and administrative controls, preventative maintenance and safe work procedures (including lockout/tagout), and ongoing safety training. Where hazards cannot be adequately controlled by these means, workers are to be provided with appropriate, well-maintained, personal protective equipment. Workers shall not be disciplined for raising safety concerns.

- Machine Safeguarding - Production and other machinery is to be evaluated for safety hazards. Physical guards, interlocks and barriers are to be provided and properly maintained where machinery presents an injury hazard to workers.
- Industrial Hygiene - Worker exposure to chemical, biological and physical agents is to be identified, evaluated, and controlled. Engineering or administrative controls must be used to control overexposures. When hazards cannot be adequately controlled by such means, worker health is to be protected by appropriate personal protective equipment programs.
- Sanitation, Food, and Housing - Workers are to be provided with ready access to clean toilet facilities, potable water and sanitary food preparation, storage, and eating facilities. Worker dormitories provided by the Participant or a labour agent are to be maintained clean and safe, and provided with appropriate emergency egress, hot water for bathing and showering, and adequate heat and ventilation and reasonable personal space along with reasonable entry and exit privileges.
- Physically Demanding Work - Worker exposure to the hazards of physically demanding tasks, including manual material handling and heavy or repetitive lifting, prolonged standing and highly repetitive or forceful assembly tasks is to be identified, evaluated and controlled.

#### IV. Environmental

Vendors should recognize that environmental responsibility is integral to producing world class products. In manufacturing operations, adverse effects on the environment and natural resources are to be minimized while safeguarding the health and safety of the public.

##### The environmental standards are:

- Product Content Restrictions - Vendors are to adhere to applicable laws and regulations regarding prohibition or restriction of specific substances including labeling laws and regulations for recycling and disposal. In addition, Vendors are to adhere to all environmental requirements specified by Purchaser.
- Chemical and Hazardous Materials - Chemical and other materials posing a hazard if released to the environment are to be identified and managed to ensure their safe handling, movement, storage, recycling or reuse and disposal.
- Air Emissions - Air emissions of volatile organic chemicals, aerosols, corrosives, particulates, ozone depleting chemicals and combustion by-products generated from operations are to be characterized, monitored, controlled and treated as required prior to discharge.
- Pollution Prevention and Resource Reduction - Waste of all types, including water and energy, are to be reduced or eliminated at the source or by practices such as modifying production, maintenance and facility processes, materials substitution, conservation, recycling and re-using materials.
- Wastewater and Solid Waste - Wastewater and solid waste generated from operations, industrial processes and sanitation facilities are to be monitored, controlled and treated as required prior to discharge or disposal.

- Environmental Permits and Reporting - All required environmental permits (e.g. discharge monitoring) and registrations are to be obtained, maintained and kept current and their operational and reporting requirements are to be followed.

#### V. Ethics

Vendors must be committed to the highest standards of ethical conduct when dealing with workers, Vendors, and customers.

- Corruption, Extortion, or Embezzlement - Corruption, extortion, and embezzlement, in any form, are strictly prohibited. Vendors shall not engage in corruption, extortion or embezzlement in any form and violations of this prohibition may result in immediate termination as a Vendor and in legal action.
- Disclosure of Information - Vendors must disclose information regarding its business activities, structure, financial situation, and performance in accordance with applicable laws and regulations and prevailing industry practices.
- No Improper Advantage - Vendors shall not offer or accept bribes or other means of obtaining undue or improper advantage.
- Fair Business, Advertising, and Competition - Vendors must uphold fair business standards in advertising, sales, and competition.
- Business Integrity - The highest standards of integrity are to be expected in all business interactions. Participants shall prohibit any and all forms of corruption, extortion and embezzlement. Monitoring and enforcement procedures shall be implemented to ensure conformance.
- Community Engagement - Vendors are encouraged to engage the community to help foster social and economic development and to contribute to the sustainability of the communities in which they operate.
- Protection of Intellectual Property - Vendors must respect intellectual property rights; safeguard customer information; and transfer of technology and know-how must be done in a manner that protects intellectual property rights.

#### VI. Management System

Vendors shall adopt or establish a management system whose scope is related to the content of this Code. The management system shall be designed to ensure (a) compliance with applicable laws, regulations and customer requirements related to the Vendors' operations and products; (b) conformance with this Code; and (c) identification and mitigation of operational risks related to this Code. It should also facilitate continual improvement.

The management system should contain the following elements:

- Company Commitment - Corporate social and environmental responsibility statements affirming Vendor's commitment to compliance and continual improvement.
- Management Accountability and Responsibility - Clearly identified company representative[s] responsible for ensuring implementation and periodic review of the status of the management systems.

- Legal and Customer Requirements - Identification, monitoring and understanding of applicable laws, regulations and customer requirements.
- Risk Assessment and Risk Management - Process to identify the environmental, health and safety and labour practice risks associated with Vendor's operations. Determination of the relative significance for each risk and implementation of appropriate procedural and physical controls to ensure regulatory compliance to control the identified risks.
- Performance Objectives with Implementation Plan and Measures - Areas to be included in a risk assessment for health and safety are warehouse and storage facilities, plant/facilities support equipment, laboratories and test areas, sanitation facilities (bathrooms), kitchen/cafeteria and worker housing /dormitories. Written standards, performance objectives, targets and implementation plans including a periodic assessment of Vendor's performance against those objectives.
- Training - Programs for training managers and workers to implement Vendor's policies, procedures and improvement objectives.
- Communication - Process for communicating clear and accurate information about Vendor's performance, practices and expectations to workers, Vendors and customers.
- Worker Feedback and Participation - Ongoing processes to assess employees' understanding of and obtain feedback on practices and conditions covered by this Code and to foster continuous improvement.
- Audits and Assessments - Periodic self-evaluations to ensure conformity to legal and regulatory requirements, the content of the Code and customer contractual requirements related to social and environmental responsibility.
- Corrective Action Process - Process for timely correction of deficiencies identified by internal or external assessments, inspections, investigations and reviews.
- Documentation and Records - Creation of documents and records to ensure regulatory compliance and conformity to company requirements along with appropriate confidentiality to protect privacy.

The Code is modeled on and contains language from the Recognized standards such as International Labour Organization Standards (ILO), Universal Declaration of Human Rights (UDHR), United Nations Convention against Corruption, and the Ethical Trading Initiative (ETI) were used as references in preparing this Code and may be useful sources of additional information.



## **ANNEXURE-I**

# **TECHNICAL SPECIFICATIONS**







## Technical Specification for

### 11 kV Cables

Conventional - 1CX1000, 3Cx400, 3CX300 and 3CX150 sqmm

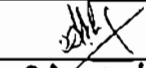
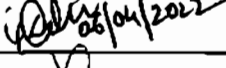
Cable in Co-Extruded Duct – 3Cx400 & 3Cx300 sq mm

Specification No: BSES-TS-15-HTC-R0

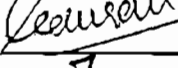
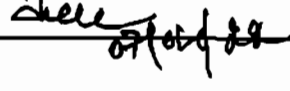
Rev:		0
Date:		6 Apr 2022
Prepared by	Abhishek Vashistha	
	Gautam Deka/Pronab Bairagi	 26/04/2022  26/04/2022
Reviewed by	Puneet Duggal	
	Amit Tomar	 26/04/2022
Approved by	Gaurav Sharma	
	K. Sheshadri	 07/04/22

## Index

<b>Sl no</b>	<b>Description</b>	<b>Page no</b>
1	General Specification	3
2	Annexure A: Scope, Documentation and Delivery Schedule	17
3	Annexure B: General Technical Particulars (GTP)	18
4	Annexure C: List of BSES approved Sub-Vendors	25
5	Annexure D : Service Conditions	27
6	Annexure E: General Arrangement Drawing of End-sealing Cap	28
7	Annexure F: General Arrangement Drawing of Pulling Eye	29
8	Annexure G: BSES format (typical) for Quality Assurance Plan (QAP) for H. T. Cables	30
9	Annexure H: Testing and manufacturing process requirements w. r. t. TR- XLPE insulation	38
10	Annexure I: Deviation format	38

## General Specification

### 1.0.0 Codes & Standards

The cables shall be designed, manufactured and tested in accordance with the following National Standards and IEC Standards.

#### National Standards

IS 7098 Part-2	Cross linked polyethylene (XLPE) insulated PVC sheathed cables for working voltages from 3.3 kV up to and including 33 kV.
IS 5831 : 1984	PVC insulation & sheath of electric cables.
IS 10810 : 1984	Methods of test for cables.
IS 8130 : 1984	Conductors for insulated electric cables and flexible cords.
IS 3975 : 1999	Mild steel wires, formed wires and tapes for armouring of cables.
IS 0462 (Part 1) / 1983	Fictitious Calculation Method for determination of dimensions of protective covering of cables

#### International Standards

IEC 60183	Guide to the selection of high voltage cables
IEC 60228	Conductors of insulated cables. Guide to the dimensional limits of circular conductors.
IEC 60332 – 3	Tests on electric cables under fire conditions. Part 3: Tests on bunched wires or cables.
IEC 60502 – 2	Power cables for rated voltages from 6 kV ( $U_m = 7.2$ kV) up to 30 kV ( $U_m = 36$ kV)
IEC 60811 Pts 1 through 5	Common test methods for insulating and sheathing materials of electric cables.
IEC 885 Pts 1 through 3	Electric test methods for electric cables.
IEC 28	International Standard of Resistance for Copper
IEC 332	Test on Electric Cables under fire conditions

### 2.0.0 Cable Construction Features

This Specification generally covers following types / sizes of TR-XLPE H. T. Cables used in BSES network in Delhi area, mostly under-ground (buried, with chances of flooding by water) or for laying on racks, in ducts, trenches, conduits, and so on.

Technical Specification for 11 kV Cables (1CX1000,3Cx400, 3CX300 and 3CX150 sqmm)

Note: (Ref.: Table stating Cable sizes given below.)

Cable Code:

As per IS, cable designations comprise of following codes / options, as applicable for this Specification:

(N.A. - Not applicable for Specification)

- (with Copper conductor) (N.A.)  
 A Aluminium conductor

-----  
 2X XLPE insulation  
 -----

W Steel round Wire armour (N.A.)  
 WW Double steel round Wire armour (N.A.)  
 Wa Non-magnetic round Wire armour  
 F Steel formed wire (strip) armour  
 FF Double steel formed wire (strip) armour (N.A.)  
 Fa Non-magnetic formed wire (strip) armour (N.A.)  
 - ("un-armoured" or without armour) (N.A.)  
 -----

Y PVC outer sheath

Sr. No.	Description	Conductor Material	Cable Code
1.	11 kV, 3c x 150 sq. mm.	Al	A 2X F Y
2.	11 kV, 3c x 300 sq. mm. (conventional)	Al	A 2X F Y
3	11 kV, 3c x 300 sq. mm. cable in co-extruded Duct	Al	A 2X F 2Y 2Y
4	11 kV, 3c x 400 sq. mm. (conventional)	Al	A 2X F Y
5	11 kV, 3c x 400 sq. mm. cable in co-extruded Duct	Al	A 2X F 2Y 2Y
6.	11 kV, 1c x 1000 sq. mm.	Al	A 2X Wa Y

Technical Specification for 11 kV Cables (1CX1000,3Cx400, 3CX300 and 3CX150 sqmm)  
Description of each item mentioned in the Specification (the text, BOQ, GTP or any site specific requirement) shall be followed, along with IS: 7098 – Part 2.

2.1.1	<b>Conductor</b>	<ul style="list-style-type: none"> <li>a) Electrolytic Grade Stranded Aluminium Conductor</li> <li>b) Grade: H2 as per IS: 8130 / 1984 (For Al)</li> <li>c) Stranded, compacted and circular in shape</li> <li>d) Class 2</li> <li>e) “Longitudinal Water-Blocking Arrangement” (or water-tight construction or water barrier protection) shall be provided within the Conductor.               <ul style="list-style-type: none"> <li>i) As per manufacturer’s procedures, 100 % water-tight conductor shall be achieved.</li> <li>iii) Make &amp; Type of materials to be used (i.e. Water-swellable tapes / yarn / powder, etc.) shall also be stated in the List of Sub-Vendors for pre-order approval.</li> </ul> </li> <li>f) All detailed constructional features shall be shown in the cross-sectional drawing.</li> </ul>
2.1.2	<b>Conductor Screen</b>	<p>Extruded semi-conducting material. (Also refer Cl. 2.1.3.) (Tapes are not acceptable)</p>
2.1.3	<b>Insulation</b>	<ul style="list-style-type: none"> <li>a) Extruded XLPE (Cross-Linked Poly-Ethylene) Insulation, with water-tree retardant (WTR) property</li> <li>b) The required compound used shall be from BSES-approved sub-vendors and not from any other (refer Annexure – C).</li> <li>c) Uniform thickness of insulation shall be within</li> </ul>

Technical Specification for 11 kV Cables (1CX1000,3Cx400, 3CX300 and 3CX150 sqmm)

		the permissible values as per IEC Standards; eccentricity check shall be carried out to ensure this. d) Insulation Color : natural
2.1.4	<b>Insulation Screen</b>	a) Freely-strippable semi-conducting screen, which should not require application of heat for its removal. (Refer Cl. 2.1.3.) b) Text “Do not Heat - Freely Strippable” to be printed on insulation screen (at every 600 mm interval). c) Round shape over the outer semi-con shall be within the permissible limits as per IEC standards; Ovality (2% max) check shall be carried out to ensure this. d) Compound used shall be suitable for the operating temperature of the Cable and shall be compatible with the insulation used.
2.1.4A	<b>XLPE Process</b>	
2.1.4A-1	11 kV	Dry Cure and Dry Cool process only.
2.1.4A-2	Not in use	
2.1.4A-3	Extrusion	It is mandatory that Conductor Screen, Insulation and Insulation Screen shall be extruded simultaneously, in a Single One-Time Process (i.e. as a triple-head extrusion) to ensure homogeneity of layers over the conductor, and absence of voids.
2.1.4A-4	Make of Compounds for Insulation and Semi-conducting	Any deviation from Approved Makes mentioned in Annexure-C shall not be acceptable, unless the deviation has been specifically approved by BSES during tendering stage
2.1.5	<b>Water-Swell able Tape</b>	a) Semi-Conducting Water-Sellable Tape shall be provided, under the copper tape, on each core.

Technical Specification for 11 kV Cables (1CX1000,3Cx400, 3CX300 and 3CX150 sqmm)

		<ul style="list-style-type: none"> <li>b) Nominal thickness : 0.3 mm</li> <li>c) Weight: 118 gm / sq. m approx.</li> <li>d) Swell height: <math>\geq 12</math> mm in 1 min.</li> <li>e) Compatible to strippable / non-strippable semi-con, over which it is applied.</li> </ul>
2.1.6	<b>Core Identification</b>	<ul style="list-style-type: none"> <li>a) For 3-core cables, cores shall be identified by coloured strips (Red, Yellow, Blue), applied helically / longitudinally below the copper tape.</li> </ul> <p>The coloured strips shall carry the name of cable manufacturer permanently printed at 1 meter intervals; this is to provide additional identification of manufacturer of the cable.</p>
2.1.6A	<b>Copper Tape</b>	Copper Tape shall be applied helically over the layer formed after application of insulation screen, water-swell able tape and identification strip. Zero negative tolerance in thickness of copper tape
2.1.7	<b>Filler</b>	<ul style="list-style-type: none"> <li>a) All interstices, including center interstices shall be filled by PP filler.</li> <li>b) PP Filler shall be non-hygroscopic, not having any effect on other compounds used, stable at cable temperatures, etc.</li> <li>c) PVC filler is not acceptable.</li> <li>d) Filler is not applicable for single-core cables.</li> </ul>
2.1.8	<b>Binder Tape</b>	As per manufacturer's standard
2.1.9	<b>Inner Sheath</b>	Extruded Inner Sheath of Black PVC type ST-2 (IS 5831)
2.1.10	<b>Armour</b>	<ul style="list-style-type: none"> <li>a) For 3-core Cables : Galvanised Steel flat strip armour</li> <li>b) For 1-core Cables :</li> </ul>



Technical Specification for 11 kV Cables (1CX1000,3Cx400, 3CX300 and 3CX150 sqmm)

		<p>Non-magnetic round wire armour (hard-drawn aluminium wire)</p> <p>c) Minimum area of coverage of armouring shall be 90 % (min.). At any time, the gap between any two adjacent armour strips / wires shall not be more than the width of strip / diameter of wire.</p> <p>d) Zero negative tolerance is for :</p> <ul style="list-style-type: none"> <li>• Thickness of armour strip</li> <li>• Diameter of armour wire</li> </ul>
2.1.11	<b>Binder Tape</b>	Rubberised cotton tape
2.1.12	<b>Outer Sheath</b>	
2.1.12.1	<b>For Conventional cable</b>	<p>a) Extruded outer sheath of PVC (ST-2 as per IS 5831) with termite-repellant and anti-rodent properties. Color - Blue (Outer Sheath shall be FRLS-type, if chosen by purchaser.)</p>
2.1.12.2	<b>For 3Cx300 &amp; 3Cx400 sq mm CCD cable (Cable in Co-extruded duct)</b>	<p>a) Inner Layer- Extruded PE compound Type HDPE ST7 (Black)- Thickness 3.00 mm</p> <p>b) Outer Layer- Extruded PE compound Type HDPE ST7 ; Thickness 2 mm, color Orange (IS 557) or other color as per Tender requirement</p>
		<p>b) Shape of the cable over the outer sheath shall be circular, when manufactured / completed. Regular Ovality check shall be carried out at factory, to detect any abnormality. Manufacturing quality shall be such that cable will retain its circular shape, even after it is laid at site.</p>
		<p>c) The Outer Sheath shall be embossed as well as laser printed with following minimum text at a interval of 1 mtr:</p> <ol style="list-style-type: none"> <li>1. The voltage designation</li> <li>2. Type of construction / cable code</li> </ol>

Technical Specification for 11 kV Cables (1CX1000,3Cx400, 3CX300 and 3CX150 sqmm)

		<p>(e.g. A2XFY)</p> <ol style="list-style-type: none"> <li>3. Manufacturer's Name and Trade-mark</li> <li>4. Number of cores and nominal cross-sectional area of conductor</li> <li>5. Name of buyer / purchaser,</li> <li>6. Month &amp; Year of manufacturing</li> <li>7. IS reference, i.e. IS : 7098</li> <li>8. Batch No. / Lot No.</li> </ol> <p>(For traceability purpose, in case of any, in case of any manufacturing defect or otherwise arising in the cable in future.)</p> <ol style="list-style-type: none"> <li>9. Purchase Order Number &amp; date</li> <li>10. Word ' FRLSH ', in case the cable is of FRLSH type.</li> </ol> <p>Note:</p> <ol style="list-style-type: none"> <li>a) Drum No. &amp; Progressive (sequential) length marking shall be provided by Laser Printing at every meter with proper contrast in coloring</li> <li>b) Progressive length marking for every drum shall be starting from zero for every drum.</li> </ol>
2.1.13	<b>Sealing-end Cap at both ends</b> (for Cables)	Cable both ends (inner and outer end) shall be sealed as per drawing MISC/E/4-1131/1698. One PVC cap with Polyurethane compound shall be provided as primary sealing and heat-shrink end-cap shall form a secondary sealing over the PVC cap.
2.1.14	<b>Pulling-eye Assembly at one end, Sealing-end cap at other end</b> (if required as per tender requirement)	A cable pulling-eye assembly as per Drg. No. MISC/E/4-1131/1698 shall be provided at the loose end (outer end) of the cable on each drum. Sealing material shall be filled in inside the spaces / gaps between the pulling-eye assembly and cable outer sheath. Further, a heat-shrinkable sleeve shall be provided over the pulling-eye assembly and outer

Technical Specification for 11 kV Cables (1CX1000,3Cx400, 3CX300 and 3CX150 sqmm)

		sheath of cable. If pulling eye is required as per tender requirement, sealing end cap shall be required for only one end of cable.
3.0.0	(This number not used.)	
4.0.0	<b>Testing &amp; Inspection</b>	Tests shall be carried out in accordance with IS 7098 (Part-2).
	a) Type Tests (IS 7098, IEC)	<p>1) <u>To Qualify in Tender:</u> Cables must be of type tested quality. Type Test Reports shall be submitted for the type, size and rating of cable offered in the bid. For participation in the tender Type Test report shall be submitted from CPRI/ERDA only and shall not be more than 5 years old from the date of tender. If the report is more than 5 years and but less than 10 years old than bidder to submit undertaking that there is no design changes from the Type test conducted.</p> <p>2) <u>Type Test Required After Award of PO:</u> Type test on one cable drum of each type/rating from any lot shall be conducted at CPRI/ERDA on sample basis as per relevant IS/IEC. Sample shall be sealed by BSES during inspection of cable. This type test is applicable subject to BSES requirement and cost shall be borne by BSES.</p>
	b) BSES QAP (Typical)	In general, all tests mentioned in the BSES QAP (Characteristics – Typical) mentioned in Annexure-F shall be included in the Routine Tests, Type Tests and Acceptance Tests stated above.
	c) Routine Tests	<ol style="list-style-type: none"> <li>1. Measurement of Electrical Resistance</li> <li>2. HV Test with power frequency AC voltage</li> <li>3. Partial Discharge test</li> <li>4. “Strippability Test” at both the ends of cable for each drum, to check the freely-strippable</li> </ol>

Technical Specification for 11 kV Cables (1CX1000,3Cx400, 3CX300 and 3CX150 sqmm)

		<p>property of the Insulation Screen (outer semi-con).</p> <ol style="list-style-type: none"> <li>5. Impulse voltage test of one drum</li> <li>6. Armour coverage measurement</li> <li>7. Physical test-Dimensions of each and every layer and components.</li> </ol> <p>Test results from the above tests must appear in the documents forwarded by the vendor for Inspection call / waiver.</p>
	<p>d) Inspection</p>	<ol style="list-style-type: none"> <li>1. The Buyer reserves the right to witness all tests specified on completed cables.</li> <li>2. The Buyer reserves the right to inspect cables at Sellers works at any time prior to dispatch, to verify compliance with the specifications.</li> <li>3. In-process (stage inspection) and final inspection call intimation shall be given at 10 days advance to the purchaser along with complete manufacturing scheduled.</li> <li>4. Minimum lot size of Cables to be offered for inspection shall be mutually agreed between Purchaser and Vendor, before placing the order. Vendor shall raise inspection call only after a minimum lot size is ready and with due factory routine tests already carried out.</li> </ol>
	<p>e) Acceptance Tests</p>	<p>Acceptance Tests shall be conducted as per Cl. 18.2 of IS 7098 (Part-2) and the approved Quality Assurance Plan (QAP) for each lot of cables.</p> <p>Following tests shall also be carried out during the Acceptance Tests :</p> <ol style="list-style-type: none"> <li>a) "Wafer Boil Test" for checking integrity of semi-conducting layers-in each lot.</li> <li>b) "Void-and-contamination Test" for the Insulation-in each lot</li> <li>c) "Strippability Test" at both the ends of cable for each drum, to check freely-strippable property of</li> </ol>

Technical Specification for 11 kV Cables (1CX1000,3Cx400, 3CX300 and 3CX150 sqmm)

		<p>the Insulation Screen (outer semi-con) - in each lot.</p> <p>d) "Water Penetration Test (WPT)", as per applicable IEC standards, to check adequacy of water-blocking arrangement provided inside the conductor -in each lot.</p> <p>e) Impulse voltage test – in each lot sample basis.</p> <p>f) Heating Cycle along with potential once per PO on sample basis.</p>
	f) Test Certificates (TC)	<p>Three sets of complete Test Certificates (Routine tests and Acceptance tests) shall be submitted along with the delivery of cables.</p> <p>Soft copy of the TCs shall be separately e-mailed to the Purchaser.</p> <p><b>Note :</b> Make/grades of critical materials (such as, for conductor screen, insulation, insulation screen, etc.), actually used during manufacturing of cables for order-on-hand, shall be clearly stated in the TCs forwarded by the Manufacturer, enabling references in future.</p>
5.0.0	<b>Drawing, Data and Manuals</b>	<p>a) Refer Annexure-A regarding Document Submission.</p> <p>b) Cross-Sectional Drawing shall show every feature of construction, including the thickness / diameter over every layer. This drawing shall also state the text to be embossed over the outer sheath - i.e. type/size, etc. of the cable, drum no./lot no., sequential marking over every meter, printing text on outer semi-con ("Do Not Heat-Freely Strippable"), font sizes to be used, additional text, if any, etc. Also, drum details, markings to be made on both sides of the drum, and so on.</p>

Technical Specification for 11 kV Cables (1CX1000,3Cx400, 3CX300 and 3CX150 sqmm)

5.0.1	Documents to be submitted along with bid	The vendor shall submit : a) Cross-sectional drawing b) GTP (all data to appear) c) Type Test certificates d) Fault Level Calculation for armour and copper tape screen e) Complete Cable Catalogue and Manual f) Armour Coverage Calculation g) Raw materials make list
5.0.2	Documents after award of contract	Within 15 days, the seller has to submit four sets of above-mentioned drawings, along with one soft copy for buyer's approval.
5.0.3	Final As-Built Drawings	One soft copy of all documents, including type & routine test certificates.
6.0.0	<b>Drum length &amp; tolerance</b>	Cable length per drum
6.0.1	a) 11 kV, 3Cx150 sqmm b) 11kV , 3Cx300 sqmm c) 11 kV, 1Cx1000 sqmm d) 11kV , 3Cx400 sqmm	300 mtr +/- 5% or 500 mtr +/- 5% (100% of the ordered quantity) as per tender requirement
6.0.2	Overall tolerance	- 2 % for the total cable length for the entire order.
6.0.3	Short length of cables	Manufacturer shall take prior approval from Purchaser for any supply of short length cables.  For 11 kV cables, minimum acceptable short length cables can be 250 meter.  In any case, manufacturer shall not put two cable pieces of different short lengths in same cable drum.

Technical Specification for 11 kV Cables (1CX1000,3Cx400, 3CX300 and 3CX150 sqmm)

		Only one short length drum shall be accepted and in last lot only.
7.0.0	<b>Packing, Shipping, Handling &amp; Storage</b>	
	a) Packing	<p>a) Both the ends of the cables shall be properly sealed to prevent any deterioration of the cable, due to ingress of water, etc.</p> <p>b) Cable inner end (starting end) shall project, outside the completely wound cable, by sufficient length enabling verify cable details, including the initial length marking.</p> <p>c) Similarly, outer end of the cable shall be saddled / secured to the drum properly to prevent any external damage to the end at any time.</p> <p>d) Before putting on wooden planks, protective covers (thick plastic sheets, etc.) shall be secured over the wound cable, to avoid any abrasion by wooden planks, over the outer sheath of the cable.</p> <p>e) After providing the protective covers, the cable drums shall be finally closed by wooden planks (with saddles), without leaving any gaps between the planks; i.e. 100 % covering shall be ensured.</p>
	b) Drum Identification Markings:	<p>Direct marking (i.e. text painting through stencils, etc.) shall be done on the drums, instead of attaching labels, which may be misplaced/lost over a period of time.</p> <p>a) Drum identification number</p> <p>b) Cable voltage grade</p> <p>c) Cable code (e.g. A2XFY, etc.)</p> <p>d) Number of cores and cross sectional area</p> <p>e) Cable quantity, i.e. cable length (meter)</p>

Technical Specification for 11 kV Cables (1CX1000,3Cx400, 3CX300 and 3CX150 sqmm)

		<p>f) Purchase order number &amp; date</p> <p>g) SAP item code</p> <p>h) Total weight of cable and drum (kg)</p> <p>i) Manufacturer's Name</p> <p>j) Buyer's name</p> <p>k) Month &amp; Year of Manufacturing</p> <p>l) Direction of rotation of drum</p> <p>m) Cable length final end-markings (i.e., reading at the inner end and reading at the outer end, just before packing, shall be marked on the drum.)</p>
	c) Shipping information	The seller shall give complete shipping information concerning the weight, size of each package
	d) Transit damage	The seller shall be responsible for any transit damage due to improper packing.
	e) Type of Drum	Wooden or Steel drums as per tender requirement (all the drums shall be non returnable except otherwise mentioned in the tender), as per relevant IS / IEC.
	f) Cable Drum handling	The drums shall be with M.S. spindle plate (with nut-bolts) of adequate size to suit the spindle rods, normally required for handling the drums, according to expected weight of the cable drums.
8.0.0	<b>Quality Assurance Plan (QAP)</b>	
8.0.1	Vendor's QAP	Manufacturer shall submit QAP in line with BSESQAP (Annexure-F) for purchaser's approval before starting of manufacturing which is mandatory
8.0.2	Inspection Points	As per BSES approved QAP and special BSES requirement if any to cross check the product quality. Seller must have to meet the special requirement of BSES during inspection.
9.0.0	<b>Progress Reporting</b>	



## Technical Specification for 11 kV Cables (1CX1000,3Cx400, 3CX300 and 3CX150 sqmm)

9.0.1	Outline Document	To be submitted for purchaser's approval for outline of programmes for production, stage-inspection, testing, final inspection, packing, dispatch and documentation.
9.0.2	Detailed Progress Report	To be submitted to Purchaser once a month containing : i) Progress on material procurement ii) Progress on fabrication (as applicable) iii) Progress on assembly (as applicable) iv) Progress on internal stage-inspection v) Reason for any delay in total programme vi) Details of test failures, if any, during manufacturing stages. vii) Progress on final box-up Constraints / Forward Path
10.0.0	<b>Deviation</b>	a) Deviations from this specification shall be listed separately by bidder clause wise (format given in Annexure- H) along with optional offer and has to submit the list along with bid/quotation. BSES will review the deviations and if BSES is agreed with the deviation, seller has to take written confirmation from BSES on deviation during tender evaluation. b) In the absence of any separate list of deviations from the bidders with bid as well as written confirmation from BSES on deviations, it will be assumed by the Buyer that the Seller complies with the Specification fully. c) Any deviations mentioned in any other submitted bid documents (i.e.in filled GTP, Catalog, BSES old approval, buyer's/seller's standards etc.) by seller without separate deviation sheets will not consider as a deviation from this tech spec at any stage of contract.

**Annexure – A****Scope, Documentation and Delivery schedule**

Document/Drawing submission shall be as per the matrix given below:

- a. All documents/drawings shall be provided in soft copy only in returnable Pen drives
- b. Language of the documents shall be English only.
- c. Incomplete submission shall be liable for rejection.
- d. Document check sheet compliance shall be the first sheet for each submission stage i.e. Technical bid, Drawing Approval, Pre Dispatch, Pre closure
- e. No submission is acceptable without check list compliance.
- f. Deficient/ improper document/ drawing submission shall be liable for rejection.
- g. Order of documents shall be strictly as per the check list.
- h. Any document not included in the below table but necessary for detailed engineering shall be deemed to be included in bidder's scope

S.No.	Detail of Document	For Tender	For Approval/Review	Final Submission
1	Guaranteed Technical Particulars (GTP)	Required	Required	Required
2	Deviation Sheet, if any	Required	Required	Required
3	Detailed cross sectional drawing of cable and drum	Required	Required	Required
4	Installation Instructions		Required	Required
5	Manual/Catalogue	Required	Required	Required
6	Cable de-rating factors		Required	Required
7	Type test reports of offered type and rating of cable	Required	Required	Required
8	BIS certificate	Required		
9	Make of Raw Materials	Required	Required	Required
10	Inspection and test reports, carried out in manufacturer's works			Required
11	Routine Test Certificates			Required
12	Test certificates of all the raw materials			Required

**Annexure - B**
**GUARANTEED TECHNICAL PARTICULARS (GTP)**
**Note:**

- 1) For every type / size of cable, every data shall be mentioned.
- 2) Seller may submit separate GTP for every type / size of cable, as suitable.
- 3) GTP requirements are generally as per IS: 7098 (Part-II).
- 4) GTP shall be read in line with purchaser's Project Site Specific Requirement.

Sr. No.	Description	Buyer's requirement	Unit	Seller's Data
1.0	Purchase Req. No.	-		
2.0	Guarantee Period (Min.)	60 Months (from date of commissioning) / 66 Months (from date of receipt at purchaser's store) whichever is earlier		
3.0	Applicable IS / IEC Standard followed by vendor	IS 7098 Part-2 / IEC 60502-2		
4.0	Make	-		
5.0	<b>Type</b> (as required by purchaser)			
	a) 11 kV, 3c x 150 sq. mm.	A2XFY		
	b) 11 kV, 3c x 300 sq. mm.	A2XFY		
	c) 11 kV, 3c x 300 sq. mm. CCD	A2XF2Y2Y		
	d) 11 kV, 3c x 400 sq. mm.	A2XFY		
	e) 11 kV, 3c x 400 sq. mm. CCD	A2XF2Y2Y		
	f) 11 kV, 1c x 1000 sq. mm.	A2XWaY		
6.0	<b>Voltage Grade</b>			
	a) 11 kV, 3c or 1c	6.35 / 11	kV	
7.0	Maximum Conductor temperature			
	A Continuous	90	deg. C	
	B Short time	250	deg. C	
8.0	<b>Conductor</b>	Compacted, Circular, Water tight construction is mandatory		

Technical Specification for 11 kV Cables (1CX1000,3Cx400, 3CX300 and 3CX150 sqmm)

A	Material and Grade	As per Cl. 2.1.1		
B	Size	As shown under 5.0 above		
C	Wires in each conductor	As per Table 2 of IS 8130	Nos.	
D	Conductor Shape	As per Cl. 2.1.1 c		
E	Dia. of wires in each conductor before compaction	Manufacturer Standard	Mm	
F	Diameter over conductor		Mm	
G	Maximum Conductor resistance at 20 ° C			
	a) 11 kV, 3c x 150 sq. mm.	0.2060	ohm/km	
	b) 11 kV, 3c x 300 sq. mm.	0.1000	ohm/km	
	c) 11 kV, 3c x 400 sq. mm.	0.0778	ohm/km	
	d) 11 kV, 1c x 1000 sq. mm.	0.0291	ohm/km	
H	Longitudinal Water Blocking Arrangement within conductor	Is it provided and shown in the cross-sectional drawing? (Yes / No)		
I	Short circuit current-carrying capacity of conductor		kA for 1 sec.	
9.0	<b>Conductor Screen</b> (inner semi-con)			
A	Material & type	As per Cl. 2.1.2		
B	Thickness (min)	0.50	Mm	
C	Diameter over conductor screen		Mm	
D	Make and grade of semi-conducting compound			
10.0	<b>Insulation</b>			
A	Insulation Material	As per Cl. 2.1.3		
B	Nominal thickness			
	a) 11 kV, 3c or 1c	3.6	Mm	
C	Minimum thickness			
	a) 11 kV, 3c or 1c	3.14	Mm	
D	Diameter over Insulation		Mm	
E	Make and grade of Insulation compound			
F	Eccentricity	As per IEC standards	%	
G	Water-tree retardant property	Required		
11A.	<b>Insulation Screen</b> (outer semi-con)			
a.	i) Thickness of freely strippable Semi conducting screen	0.50	Mm	
	ii) Make and grade of semi-conducting compound			
	iii) Printing	As per Cl. No. 2.1.4 (Yes / No)		

Technical Specification for 11 kV Cables (1CX1000,3Cx400, 3CX300 and 3CX150 sqmm)

	iv) Ovality of the core (max)	2	%	
b.	Diameter over Insulation Screen (approx.)		Mm	
11B.	<b>Water-Swellable Tape</b> (if required by Purchaser)			
	a) Thickness b) Weight c) Swell height d) Compatible to strippable / non-strippable semi-con, over which it is applied. e) Make & Grade f) Pre-slitted packed tapes from sub-vendors approved by BSES	a) 0.3 mm b) 118 gm / sq. m c) ≥ 12 mm in 1 min. d) Yes / No  e) Pl. state f) Yes / No		
11C.	<b>Cable Core identification</b>  a) By coloured strips over cores applied helically / longitudinally b) Manufacturer's name shall be permanently printed on the strips, at close intervals.			
11D.	<b>Copper Tape</b>			
	i) Dimensions	a) Thickness : 0.06 + 5 % b) Width : 50 mm  C) Overlap: 10% d) no negative tolerance in thickness of copper tape	Mm	
	ii) Fault current-carrying capacity of copper tape	Manufacturer's Standard (Calculation sheet shall be attached)	... kA for ... sec.	
11E.	Diameter over laid up core (approx.)		Mm	

Technical Specification for 11 kV Cables (1CX1000,3Cx400, 3CX300 and 3CX150 sqmm)

12.0	<b>Filler</b> (Material and type)	As per Cl. 2.1.7 (Specify no. & size of filler at center & core interstices)		
	a) 11 kV, 3c x 150 sq. mm.			
	b) 11 kV, 3c x 300 sq. mm.			
	c) 11 kV, 3c x 400 sq. mm.			
	d) 11 kV 1core	Not applicable		
12A.0	<b>Binder Tape</b>	over laid-up cores		
13.0	<b>Inner Sheath</b>			
A	Material and type	As per Cl. 2.1.9		
B	Minimum thickness			
	a) 11 kV, 3c x 150 sq. mm.	0.6	Mm	
	b) 11 kV, 3c x 300 sq. mm. (conventional & CCD)	0.7	Mm	
	c) 11 kV, 3c x 400 sq. mm. (conventional & CCD)	0.7	Mm	
	d) 11 kV, 1c x 1000 sq. mm.	0.7	Mm	
C	Approx. dia. over inner sheath		Mm	
14.0	<b>Armour</b>	as per purchaser's requirements		
A	Material			
	a) 11 kV, 3c	G. I. Strip	No.	
	b) 11 kV 1c	non-magnetic wire armour (Aluminium wire)	No.	
B	Armour – Wires	As per Table 6 of IS 7098 Part-2 (zero negative tolerance for diameter)	mm.	
	a) Diameter of wire			
	b) Number of wires (min.)		no.	
C	Armour – GI strips		mm	
	a) Width of strip & Thickness of strip	a) 6.1 x 1.4 (zero negative tolerance for thickness)		
	b) Number of strips (min.)	b) Vendor to specify	no.	
D	Approx. Equivalent Area		sq. mm.	
E	Area covered by armour	Min. 90 % Calculation shall be attached.	%	
F	Dia. over armour - approx.		Mm	
G	Fault current carrying capacity of armour	Calculation sheet shall be attached.	... kA for ... sec.	
15.0	<b>Outer Sheath</b>			
A	Material and type	As per Cl. 2.1.12		

Technical Specification for 11 kV Cables (1CX1000,3Cx400, 3CX300 and 3CX150 sqmm)

B	Thickness (min.)	** As per Table-5 of IS 7098 Part-2		
	a) 11 kV, 3c x 150 sq. mm.	**	mm	
	b) 11 kV, 3c x 300 sq. mm. Conventional cable	**	mm	
	c) 11 kV, 3c x 400 sq. mm. Conventional cable			
	d) 11 kV, 1c x 1000 sq. mm.	**	mm	
	e) 11 kV, 3c x 300 sq. mm. CCD cable	As per Cl. 2.1.12		
	f) 11 kV, 3c x 400 sq. mm. CCD cable			
C	Color	As per Cl. 2.1.12		
D	Embossing (details as per Cl. 2.1.12)	Yes		
E	FRLS Properties	As per customer's requirement		
16.0	Approx. overall diameter		mm	
17.0	Standard drum length with tolerance			
	a) 11 kV, 3Cx150 sqmm b) 11kV , 3Cx300 sqmm conventional or CCD c) 11kV , 3Cx400 sqmm conventional or CCD d) 11kV , 1Cx1000 sqmm	500 mtr +/- 5% or 300 mtr +/- 5%	meters	
17A	Overall order tolerance- <del>{R1}</del>	- 2 % for the total cable length for the entire order.		
18.0	<b>Cable Drum</b>			
	a. Type of drum	Wooden/ Steel non returnable (Specify the relevant IS / IEC followed for drum design)		
	b. Markings on the drum (as per Cl. 7.0.0)	On both faces		
18A.0	<b>Cross-Sectional Drawing</b> (ref. Cl. 5.0.0)	Is drawing submitted, showing every feature of constructions?		

Technical Specification for 11 kV Cables (1CX1000,3Cx400, 3CX300 and 3CX150 sqmm)

		(Yes / No)		
19.0	a. Sealing-end Cap (provided at the both Ends)	Yes/No Is manufacturer's / Sub-Vendor's drawing submitted? (Yes / No)		
	b. Pulling Eye at one end and Sealing-end Cap provided at other end	Yes/No Is manufacturer's / Sub-Vendor's drawing submitted? (Yes / No)		
20.0	<b>Weights</b>			
	a) Net weight of cable (approx.)		kg / km	
	b) Weight of empty drum	500 mtr/300 mtr	Kg	
	c) Weight of Cable with drum	500 mtr/300 mtr	Kg	
	d) Size of Drum	500 mtr/300 mtr	mm	
	e) Drawing of Drum	Required	EA	
21.0	Continuous current rating for standard I. S. condition laid Direct			
	a) In ground 30° C		Amp	
	b) In duct 30° C		Amp	
	c) In air 40° C		Amp	
22.0	(not used)			
23.0	Electrical Parameters at Maximum Operating temperature:			
A	AC Resistance		ohm / km	
B	Reactance at 50 c/s		ohm / km	
C	Impedance		ohm / km	
D	Zero sequence impedance		ohm / km	
E	Positive sequence impedance		ohm / km	
F	Negative sequence impedance		ohm / km	
G	Capacitance		micro-farad / km	
H	Conductance		Amperes per volts	
I	Inductive susceptance		mho	
J	Capacitive susceptance		ohms	
24.0	Recommended minimum bending radius	12 x O. D.	mm	



Technical Specification for 11 kV Cables (1CX1000,3Cx400, 3CX300 and 3CX150 sqmm)

25.0	De-rating factor for following Ambient Temperatures :	Ground / Air		
	a) At 30° C			
	b) At 35° C			
	c) At 40° C			
	d) At 45° C			
	e) At 50° C			
26.0	Group factor for following numbers of cables laid :	Touching Trefoil		
	a) 3 Nos.			
	b) 4 Nos.			
	c) 5 Nos.			
	d) 6 Nos.			
27.0	Recommended pressure for laying cable using power winch	30 N / mm <sup>2</sup>	N / sq. mm.	
28.0	Process of Cross-linking of Polyethylene			
	a) 11 kV, 3c or 1c	Dry Cure process and Dry Cooling only		
29.0	<b>Type test</b> (TTR - Type Test Report)	Is copy of latest valid TTR for respective sizes enclosed? (Yes / No)		
30.0	<b>Quality Assurance Plan</b> (QAP)	Is QAP Format (Annexure-F), duly filled in and enclosed? (Yes / No)		
31.0	<b>List of Sub-Vendors</b> for construction items (Annexure-C)	Is this list enclosed for BSES approval? (Yes / No)		

**Annexure - C****List of Sub-Vendors for critical items**

Vendor/Bidder to state sub-vendors' names for other items, wherever approved names are not mentioned, for purchaser's approval during tendering stage else purchaser shall impose as per their requirement and bidder to follow the same in post-order stages.

Ser. No.	Raw Materials		Name of the Make
1.	XLPE Compound	1	Dow Chemicals , U.S.A.
		2	Borealis , Sweden
		3	Hanwha , South Korea
2.	Semi-Conducting Compound	1	Dow Chemicals, U.S.A.
		2	Borealis , Sweden
		3	Hanwha , South Korea
3.	Conductor Water-Blocking tapes / yarn	1	Lantor
		2	Geca
		3	Miracle
		4	Scapa
		5	Sneham International
4.	Water-Swellable Tapes (Pre-slitted)	1	Lantor
		2	Geca
		3	Miracle
		4	Scapa
		5	Sneham International
5.	Aluminium Rod	1	Bharat Aluminium Co. Ltd. (BALCO)
		2	Hindustan Aluminium Co. Ltd. (HINDALCO)
		3	National Aluminium Co. Ltd. (NALCO)
		4	Vedanta (Sesa Sterlite)

## Technical Specification for 11 kV Cables (1CX1000,3Cx400, 3CX300 and 3CX150 sqmm)

Ser. No.	Raw Materials		Name of the Make
6.	Copper Tape	1	Aggarwal Metal
		2	Indian Smelting
		3	Luvata Swedan
		4	Outokumpu Copper Strip AB, Swedan
7	Galvanised Steel Wires / Strips	1	Tata
		2	Balaji
		3	Systematic
		4	Mica Wires Pvt. Ltd.
		5	Bansal Industries
8	PVC Compound	1	Kalpana
		2	Universal
		3	SCJ Plastic
		4	Sriram Polytech
		5	Shri Ram Vinyl, Kota
9	P. P. Fillers	1	Vijoy Polymers
		2	Yash Polymers
		3	AVSL Industries
10	Core Identification Tape	1	AVSL Industries
		2	Yash Polymer
		3	Vijoy Polymers
11	PE Compound	1	Borealis
		3	Shakun
		4	Kalpana

**Annexure - D****Service Conditions**

(Atmospheric / Soil conditions at Site)

<b>B. Delhi</b>		
a)	Average grade atmospheric condition	Heavily polluted, dry
b)	Maximum altitude above sea level	1000 M
c)	Air temperature Ambient	i) Highest : 50 deg C ii) Average : 40 deg C iii) Minimum : 0 deg C
d)	Relative Humidity	100 % max
e)	Thermal Resistivity of Soil	150 deg. C. cm / W max.
f)	Seismic Zone	4
g)	Rainfall	750 mm concentrated in four months

# ANNEXURE E

## DIMENSIONS

SIZE	A EXP.(Min.)	A REC.(Max.)	B EXP.(Min.)	C EXP.(Min.)	D EXP.(Min.)	LC %	T (WALL REC. ± 20 %)
EC 120/150	75	34	120	105	50	± 10	4.2
EC 240/300	100	62	130	110	70	± 10	3.5
EC 400	145	75	155	120	70	± 10	4.6

EXP - Expanded (as supplied), REC - Recovered freely, LC - Longitudinal Change, T - Wall Thickness, EC - End Cap

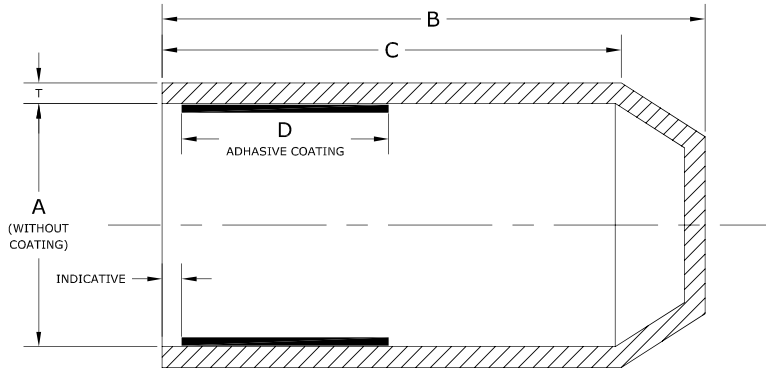

**END CAP**  
(AS SUPPLIED)  
SECTIONAL VIEW

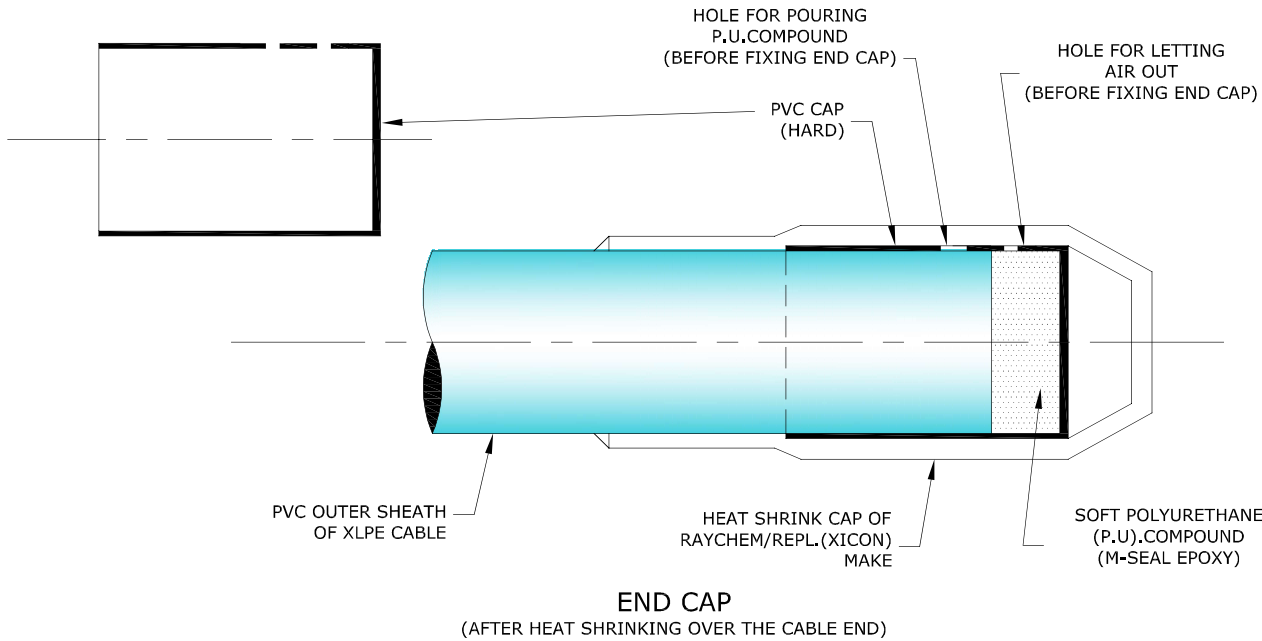

**END CAP**  
(AFTER HEAT SHRINKING OVER THE CABLE END)

## MATERIAL SPECIFICATIONS

Characteristics	Test Class	Value	Test Method
<b>A Physical Properties</b>			
1 Specific Gravity	Type	1.05 ± 0.2	ASTM D-1505
2 Water Absorption	Type	1 % (max)	ASTM D-570 / ISO 62
3 Tensile Strength	Routine	10 N/sqmm (min)	ASTM D-412 / ISO 37
4 Ultimate Elongation	Routine	300% (min)	ASTM D-412 / ISO 37
5 Hardness	Type	45 shore D ± 3	ASTM D-2240
<b>6 Thermal Test</b>			
<b>B Thermal Ageing (120°C for 500 hrs)</b>			
1 Tensile Strength	Type	8 N/sqmm (min)	ASTM D-412 / ISO 37
2 Ultimate Elongation	Type	200% (min)	ASTM D-412 / ISO 37
<b>C Electrical Properties</b>			
1 Volume Resistivity	Type	10 <sup>12</sup> ohm-cm. (min)	ASTM D-257 / IEC 93
2 Dielectrical Strength	Type	10 kV/mm. (min)	ASTM D-149 / IEC 243
3 Dielectric Constant	Type	5 (max)	ASTM D-150 / IEC 250

- Note : 1) All dimension in mm  
2) Colour Black  
3) Size as mentioned in the table shall be stencilled on respective item

# BSES

DRAWING No. MISC/E/4-1131/1698

SCALE : NOT TO SCALE

DATE: 09-05-2011

**END SEALING CAP**  
(FOR XLPE CABLE)

DRAWN BY:

CHECKED BY:

APPROVED BY:

REVISIONS

Addl. V.P.

# ANNEXURE F

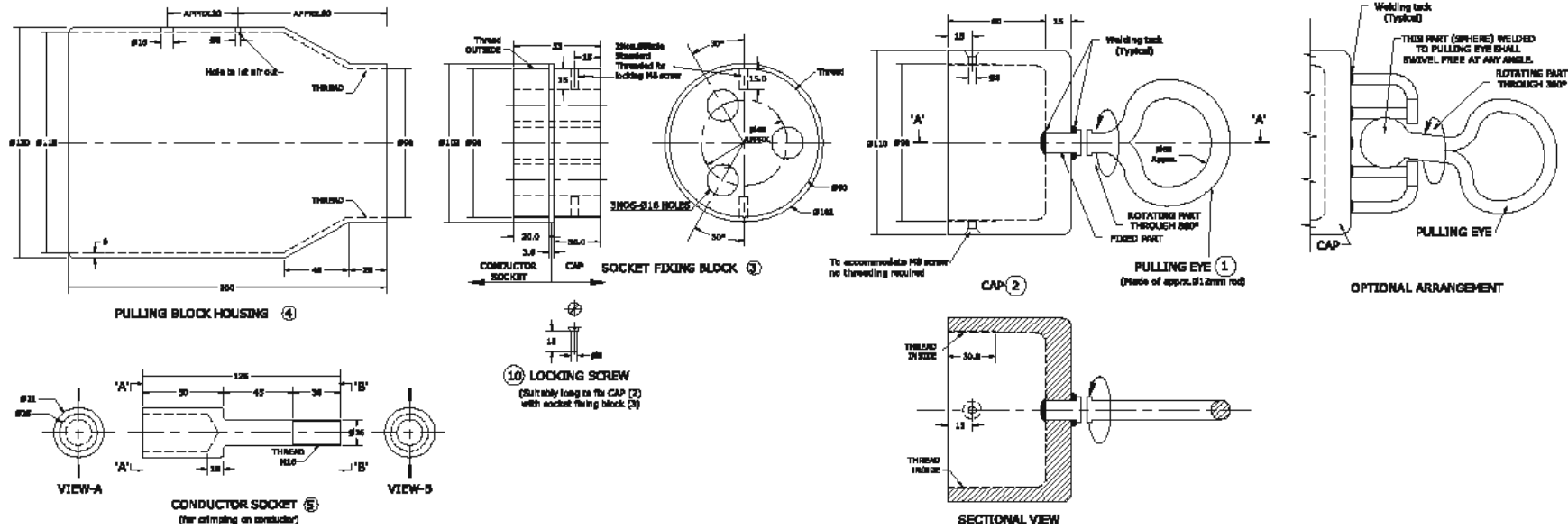

## Exploded View

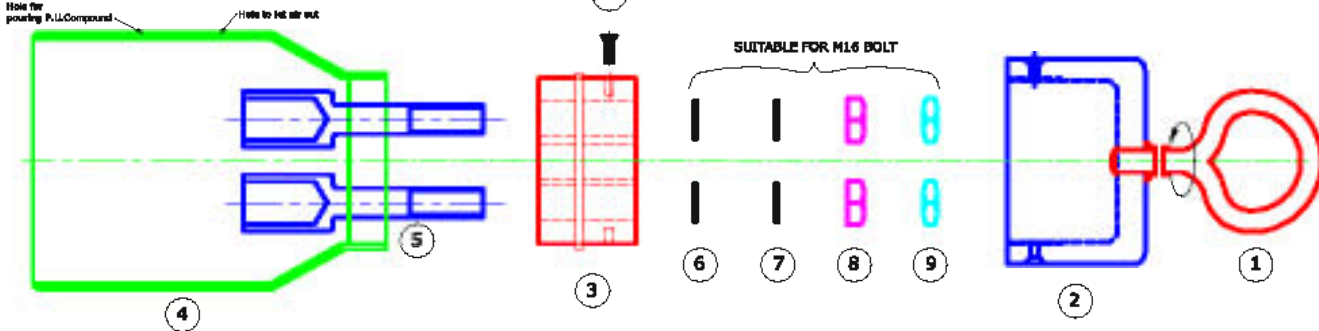

10	LOCKING SCREW	2	M.S.Zinc-Plated
9	LOCK NUT	3	M.S.Zinc-Plated
8	NUT	3	M.S.Zinc-Plated
7	SPRING. WASHER	3	M.S.Zinc-Plated
6	PLAIN WASHER	3	M.S.Zinc-Plated
5	CONDUCTOR SOCKET	3	AL
4	PULLING BLOCK HOUSING	1	M.S.Zinc-Plated
3	SOCKET FIXING BLOCK	1	M.S.Zinc-Plated
2	CAP	1	M.S.Zinc-Plated
1	PULLING EYE	1	M.S.Zinc-Plated
NO.	DISCRIPTION	QTY.	MATERIAL

# BSES

DRAWING No. **MISC/E/4-1133/1639**  
 SCALE: NOT TO SCALE DATE: 05-2011

## CABLE PULLING EYE ASSEMBLY (TYPICAL)

DRAWN BY:	CHECKED BY:	APPROVED BY:
REVISIONS		

Add VP

### EXAMPLE:

- For cable size 33kV, 3/C X 400sq mm AL XLPE.
  - Diameter over conductor : 23.8mm approx.
- Overall diameter : 108±3mm approx.  
 Pulling force applicable on the cable : 30 N/sq mm  
 Pulling eye shall withstand total force of : 36000N+Safety margin

### NOTE:

- All Dimensions are in mm, unless otherwise stated.
- This drawing is typical / Indicative. Separate dimensioned drawing for cable pulling eye assembly, suitable for required size & rating of cables, shall be submitted for approval prior to manufacturing.
- After fixing cable pulling eye, P.U.(Poly-Urethane) Compound be poured to occupy inner spaces to avoid Ingress of Water / Moisture.
- After P.U.Compound oozes/flows out from the cable side, the same edge shall be sealed with suitable sleeve/Tape.



**ANNEXURE G : QUALITY ASSURANCE PLAN (QAP)**

**FOR 11 kV H. T. CABLES**

S. NO.	COMPONENT & OPERATION	CHARACTERISTICS	CLASS	TYPE OF CHECK	QUANTUM OF CHECK	REFERENCE DOCUMENT	ACCEPTANCE NORMS	FORMAT OF RECORD	AGENCY			Remark
									SV	MFR	BSES	
1	2	3	4	5	6	7	8	9	10	11	12	13
<b>Legend : SV : Sub-Vendor of Cable Manufacturer, MFR : Cable Manufacturer, MPS : Material Purchase Specification,</b> <b>P : Perform, W : Witness, V : Verification</b>												
<b>A RAW MATERIAL</b>												
1	Aluminium/Copper Rod	a) Tensile strength	Major	Physical	Sample	MPS	MPS	Reg./Sheet	P	P/V	V	
		b) Resistivity	Major	Electrical	Sample	MPS	MPS	Reg./Sheet	P	P/V	V	
		c) Diameter	Major	Physical	Sample	MPS	MPS	Reg./Sheet	P	P/V	V	
		d) Chemical composition	Major	Chemical	Sample	MPS	MPS	Test certificate	P	V	V	
		e) Surface finish	Major	Visual	Sample			-	P	P	-	
2	PVC Compound	a) Tensile Strength	Major	Physical	Sample	MPS	MPS	Reg./Sheet	P	P/V	V	
		b) Elongation at break	Major	Physical	Sample	MPS	MPS	Reg./Sheet	P	P/V	V	
		c) Thermal stability	Major	Physical	Sample	MPS	MPS	Reg./Sheet	P	P/V	V	
3	TR-XLPE Compound (Borealis/Dow chemical/ Hanwa)	a) Packing	Minor	Visual	100%	MPS	MPS	-	P	V	-	
		b) Tensile Strength	Major	Physical	Sample	MPS	MPS	Reg./Sheet	P	P/V	V	
		c) Elongation at break	Major	Physical	Sample	MPS	MPS	Reg./Sheet	P	P/V	V	
		d) Hot set test	Major	Physical	Sample	MPS	MPS	Reg./Sheet	P	P/V	V	
		e) Volume Resistivity	Major	Electrical	Sample	MPS	MPS	Reg./Sheet	P	P/V	V	
		f) Cure Curve (Max. Torque)	Major	Physical	Sample	MPS	MPS	Reg./Sheet	-	P	V	
		g) Density	Major	Physical	Sample	MPS	MPS	Reg./Sheet	P	P/V	V	
4	Semi-conducting Compound (Borealis/Dow chemical/ Hanwa)	a) Packing	Minor	Visual	100%	MPS	MPS	-	P	V	-	
		b) Volume Resistivity	Major	Electrical	Sample	MPS	MPS	Reg./Sheet	P	P/V	V	
		c) Tensile Strength	Major	Physical	Sample	MPS	MPS	Reg./Sheet	P	P/V	V	
		d) Elongation at break	Major	Physical	Sample	MPS	MPS	Reg./Sheet	P	P/V	V	
		e) Cure Curve (Max. Torque)	Major	Physical	Sample	MPS	MPS	Reg./Sheet	-	P	V	
		f) Density	Major	Physical	Sample	MPS	MPS	Reg./Sheet	P	P/V	V	
5	Copper tape	a) Thickness & width	Major	Physical	Sample	MPS	MPS	Reg./Sheet	P	P/V	V	
		b) Tensile Strength	Major	Physical	Sample	MPS	MPS	Reg./Sheet	P	P/V	V	
		c) Elongation at break	Major	Physical	Sample	MPS	MPS	Reg./Sheet	P	P/V	V	
		d) Resistivity	Major	Electrical	Sample	MPS	MPS	Reg./Sheet	P	P/V	V	
6.	Armour wires/strips (Galvanised steel)	a) Dimensions	Major	Physical	Sample	MPS	MPS	Reg./Sheet	P	P/V	V	
		b) Surface condition/finish	Major	Visual	Sample	MPS	MPS	Reg./Sheet	P	P/V	V	
		c) Tensile Strength	Major	Physical	Sample	MPS	MPS	Reg./Sheet	P	P/V	V	
		d) Elongation at break	Major	Physical	Sample	MPS	MPS	Reg./Sheet	P	P/V	V	
		e) Torsion test for round wire	Major	Physical	Sample	MPS	MPS	Reg./Sheet	P	P/V	V	
		f) Wrapping test	Major	Physical	Sample	MPS	MPS	Reg./Sheet	P	P/V	V	
		g) Mass of zinc coating	Major	Physical	Sample	MPS	MPS	Reg./Sheet	P	P/V	V	
		h) Uniformity of zinc coating	Major	Physical	Sample	MPS	MPS	Reg./Sheet	P	P/V	V	
		i) Adhesion test	Major	Physical	Sample	MPS	MPS	Reg./Sheet	P	P/V	V	
		j) Resistivity test	Major	Electrical	Sample	MPS	MPS	Reg./Sheet	P	P/V	V	
7	Water Swellable	a) Dimensions	Minor	Physical	Sample	MPS	MPS	Reg./Sheet	P	P/V	V	



**ANNEXURE G : QUALITY ASSURANCE PLAN (QAP)**

**FOR 11 kV H. T. CABLES**

S. NO.	COMPONENT & OPERATION	CHARACTERISTICS	CLASS	TYPE OF CHECK	QUANTUM OF CHECK	REFERENCE DOCUMENT	ACCEPTANCE NORMS	FORMAT OF RECORD	AGENCY			Remark
									SV	MFR	BSES	
1	2	3	4	5	6	7	8	9	10	11	12	13
<b>Legend : SV : Sub-Vendor of Cable Manufacturer, MFR : Cable Manufacturer, MPS : Material Purchase Specification,</b> <b>P : Perform, W : Witness, V : Verification</b>												
	tape	b) Swelling height	Major	Physical	Sample	MPS	MPS	Reg./Sheet	P	P/V	V	
		c) Resistivity	Major	Electrical	Sample	MPS	MPS	Reg./Sheet	P	P/V	V	
		d) Weight	Major	Physical	Sample	MPS	MPS	Reg./Sheet	P	P/V	V	
8	Steel Drum	a) Dimension	Major	Meas.	1 sample per size	IS 10418 / Purchase order		-	P	P	-	
		b) Finish & workman ship	Minor	Visual	1 sample per size	Compliance to standard Engineering norms & free from surface defects		-	P	P	-	
9	Binder tape	a) Dimensions & material	Minor	Physical	Sample	MPS	MPS	-	P	P	-	
10	Polypropylene filler	a) Size	Minor	Physical	Sample	Purchase order	Purchase order	-	P	P	-	
11	Heat shrinkable end cap	a) Bore diameter	Major	Physical	1 sample per size	--	--	-	-	P	-	
		b) Length of end cap	Minor	Physical	1 sample per size	--	--	-	-	P	-	
<b>B PROCESS INSPECTION</b>												
1	Wire Drawing	a) Diameter	Major	Physical	Sample			Reg./Sheet	-	P	V	
		b) Surface finish	Major	Visual	100 %	Smooth & free from defects		--	-	P	-	
		c) Tensile test (for Al)	Major	Physical	Sample	IS: 8130/84	IS: 8130/84	Reg./Sheet	-	P	V	
		d) Elongation test (for Cu)	Major	Physical	Sample	IS: 8130/84	IS: 8130/84	Reg./Sheet	-	-	V	
		e) Wrapping test (for Al)	Major	Physical	Sample	IS: 8130/84	IS: 8130/84	Reg./Sheet	-	P	V	
2	Stranding	a) No. of wires/strands	Major	Physical	At the time of m/c setting			Reg./Sheet	-	P	V	
		b) Lay length & Lay direction	Major	Physical	-do-			-	-	P	V	
		c) Dia of conductor	Major	Physical	During setting & once in each shift			Reg./Sheet	-	P	V	
		d) Surface finish	Major	Visual	100 %	No surface defects and free from sharp edges, scratches, grease, oil etc.		-	-	P	-	
3	Core extrusion (Conductor screen, Insulation & insulation screen)	a) Compound Make/Grade	Major	Visual	During m/c setting			-	-	P	-	Insulation screen shall be freely strippable, without application of heat.
		b) Thickness of insulation & extruded S.C. layers	Major	Physical	During m/c setting after stabilisation	Tech. Data Sheet / IS 7098/II/2011	Tech. Data Sheet / IS 7098/II/2011	Reg./Sheet	-	P	V	
		c) Surface finish	Minor	Visual	100 %	Smooth & free from defects		-	-	P	-	
		d) Printing on outer semi- conducting layer	Major	Visual	100 %	"DO NOT HEAT, FREELY STRIPPABLE"		-	-	P	-	
		e) Tensile Strength	Major	Physical	Sample	IS 7098/II/2011	IS 7098/II/2011	Reg./Sheet	-	P	V	
		f) Elongation at break	Major	Physical	Sample	IS 7098/II/2011	IS 7098/II/2011	Reg./Sheet	-	P	V	
		g) Hot set test	Major	Physical	Sample	IS 7098/II/2011	IS 7098/II/2011	Reg./Sheet	-	P	V	
		g1) Ovality of core	Minor	Physical	Sample	Tech. Data Sheet	Tech. Data Sheet	Reg./Sheet	-	P	V	





**ANNEXURE G : QUALITY ASSURANCE PLAN (QAP)**

**FOR 11 kV H. T. CABLES**

S. NO.	COMPONENT & OPERATION	CHARACTERISTICS	CLASS	TYPE OF CHECK	QUANTUM OF CHECK	REFERENCE DOCUMENT	ACCEPTANCE NORMS	FORMAT OF RECORD	AGENCY			Remark
									SV	MFR	BSES	
1	2	3	4	5	6	7	8	9	10	11	12	13
<b>Legend : SV : Sub-Vendor of Cable Manufacturer, MFR : Cable Manufacturer, MPS : Material Purchase Specification, P : Perform, W : Witness, V : Verification</b>												
		h) Eccentricity of insulation	Minor	Physical	Sample	Tech. Data Sheet	Tech. Data Sheet	Reg./Sheet	-	P	V	
		i) Core diameter	Minor	Physical	Sample	Tech. Data Sheet	Tech. Data Sheet	Reg./Sheet	-	P	V	
		j) Void & contamination test for insulation (Silicon Oil test)	Major	Physical	Sample			-	-	P	V	
		k) Wafer boil test for extruded semi-conducting layers	Major	Physical	1 sample/lot	BIS draft Specn	BIS draft Specn	Reg./Sheet	-	P	V	
4	Taping - water Swellable semi-conducting	a) Dimensions	Minor	Physical	Sample	Tech. Data Sheet	Tech. Data Sheet	-	-	P	-	
		b) Tape Application (Overlap)	Minor	Visual	During m/c setting	Suitable overlap	Suitable overlap	-	-	P	-	
5	Taping - Copper tape	a) Width & Thickness of tape	Major	Physical	During m/c setting	Tech. Data Sheet	Tech. Data Sheet	Reg./Sheet	-	P	V	
		b) Number of tapes	Major	Visual	During m/c setting	Tech. Data Sheet	Tech. Data Sheet	Reg./Sheet	-	P	V	
		c) Tape application (Overlap)	Minor	Visual	During m/c setting	Tech. Data Sheet	Tech. Data Sheet	-	-	P	-	
6	Laying up	a) Identification of cores	Major	Visual	During m/c setting	Tech. Data Sheet	Tech. Data Sheet	-	-	P	-	Cores shall be laidup with PP fillers & suitable tape binder shall be provided over laid up assembly
		b) Direction of lay, core Sequence & Lay length	Major	Visual	During m/c setting	IS 7098/II/2011, PIL-W-02	IS 7098/II/2011, PIL-W-02	-	-	P	-	
		c) Application of binder tape	Minor	Visual	During m/c setting	Tech. Data Sheet		-	-	P	-	
		d) Shape of laid up assembly	Minor	Visual	100%	Reasonably circular	Reasonably circular	-	-	P	-	
7	Inner sheath	a) Material & type	Major	Visual	During m/c setting	Tech. Data Sheet	Tech. Data Sheet	-	-	P	-	
		b) Thickness	Major	Physical	During m/c setting & drum change	Tech. Data Sheet & IS 7098/II/2011	ech. Data Sheet & IS 7098/II/2011	Reg./Sheet	-	P	V	
		c) Surface finish	Minor	Visual	100 %	Surface shall be smooth & free from defects		-	-	P	-	
		d) Colour of inner sheath	Major	Visual	100 %	Tech. Data Sheet	Tech. Data Sheet	-	-	P	-	
8	Armouring	a) Dimension of armour wires/strips	Major	Physical	During m/c setting	Tech. Data Sheet	Tech. Data Sheet	Reg./Sheet	-	P	V	No negative tol. on strip thickness/wire diameter
		b) No. of armour strip/wire	Major	Counting	During m/c setting	Tech. Data Sheet	Tech. Data Sheet	Reg./Sheet	-	P	V	
		c) Armour coverage	Minor	Visual	During m/c setting	IS 7098/II/2011	IS 7098/II/2011	-	-	P	-	
		d) Direction of lay	Major	Visual	During m/c setting	IS 7098/II/2011	IS 7098/II/2011	-	-	P	-	
		e) Lay length/Gear setting	Minor	Visual	During m/c setting			-	-	P	-	
		f) Surface finish	Major	Visual	100 %	No cross over/over riding of wire/strip		-	-	P	-	
9	Outer sheath/Rewinding	a) Material & type	Major	Visual	During m/c setting	Tech. Data Sheet	Tech. Data Sheet	-	-	P	-	
		b) Anti rodent & termite additives	Major	Visual	Each loading			Reg./Sheet	-	P	V	



**ANNEXURE G : QUALITY ASSURANCE PLAN (QAP)**

**FOR 11 kV H. T. CABLES**

S. NO.	COMPONENT & OPERATION	CHARACTERISTICS	CLASS	TYPE OF CHECK	QUANTUM OF CHECK	REFERENCE DOCUMENT	ACCEPTANCE NORMS	FORMAT OF RECORD	AGENCY			Remark
									SV	MFR	BSES	
1	2	3	4	5	6	7	8	9	10	11	12	13
<b>Legend : SV : Sub-Vendor of Cable Manufacturer, MFR : Cable Manufacturer, MPS : Material Purchase Specification, P : Perform, W : Witness, V : Verification</b>												
		b) Thickness	Major	Physical	Each length	Tech. Data Sheet	Tech. Data Sheet	Reg./Sheet	-	P	V	
		c) Overall diameter	Major	Physical	Each length	Tech. Data Sheet	Tech. Data Sheet	Reg./Sheet	-	P	V	
		d) Surface finish & colour of sheath	Major	Visual	100 %	Surface smooth & free from defects. Colour as per Tech. Data Sheet		-	-	P	-	
		e) Cable length verification	Major	Visual	Each length	Manufacturing Plan	Manufacturing Plan	-	-	P	-	
		f) Marking	Major	Visual	Each length	As per approved GTP/cross sectiona drawing		Reg./Sheet	-	P	V	
<b>C FINAL INSPECTION</b>												
1	Routine tests	a) High Voltage	Critical	Electrical	100 %	IS 7098/II/2011	IS 7098/II/2011	Test Report	-	P	V	
		b) Conductor Resistance	Critical	Electrical	100 %	IS 8130/84	IS 8130/84	Test Report	-	P	V	
		c) Partial Discharge	Critical	Electrical	100 %	IS 7098/II/2011	IS 7098/II/2011	Test Report	-	P	V	
		d) Impulse	Critical	Electrical	One sample per lot			Test Report		P	V	
		e) Armour Coverage	Critical	Physical	One sample per lot			Test Report		P	V	
		f) Physiacal Dimensions	Critical	Physical	One sample per lot			Test Report		P	V	
		g) Freely Strippable insulation screen (Strippability Test)	Major	Physical	One sample per lot	Factory Standard	Factory Standard	Test Report	-	P	V	
2	Stage Inspection	Wire Drawing	Major	Visual	100 %	Tech. Data Sheet	IS/IEC	Test Report	-	P	W	Stage Inspection shall be conducted subject to BSES requirement
		Extrusion process	Major	Visual	100 %	Tech. Data Sheet	IS/IEC	Test Report	-	P	W	
		Raw maerial inspection at factory	Major	Physical	100 %	Tech. Data Sheet	IS/IEC	Test Report	-	P	W	
		Wrapping of Aluminium	Major	Physical	100 %	Tech. Data Sheet	IS/IEC	Test Report	-	P	W	
		Tensile test for Aluminium	Major	Physical	100 %	Tech. Data Sheet	IS/IEC	Test Report	-	P	W	
		a) Annealing test for copper	Major	Physical	Appendix A to IS 7098/II/2011, each lot sample basis	IS 8130/84	IS 8130/84	-	-	P	V	Verification of process records.
		b) Tensile test for aluminium	Major	Physical		IS 8130/84	IS 8130/84	-	-	P	V	
		c) Wrapping test for aluminium	Major	Physical		IS 8130/84	IS 8130/84	-	-	P	V	Tests N/A on finished conductor.
		d) Conductor resistance test	Major	Electrical	Appendix A to IS 7098/II/2011, each lot sample basis	IS 8130/84	IS 8130/84	Test Report	-	P	W	
		e) Test for thickness of insulation & sheath	Major	Physical		IS 7098/II/2011 & Tech. Data sheet	IS 7098/II/2011 & Tech. Data sheet	Test Report	-	P	W	
		f) Hot set test for insulation	Major	Physical		IS 7098/II/2011	IS 7098/II/2011	Test Report	-	P	W	



**ANNEXURE G : QUALITY ASSURANCE PLAN (QAP)**

**FOR 11 kV H. T. CABLES**

S. NO.	COMPONENT & OPERATION	CHARACTERISTICS	CLASS	TYPE OF CHECK	QUANTUM OF CHECK	REFERENCE DOCUMENT	ACCEPTANCE NORMS	FORMAT OF RECORD	AGENCY			Remark
									SV	MFR	BSES	
1	2	3	4	5	6	7	8	9	10	11	12	13
<b>Legend : SV : Sub-Vendor of Cable Manufacturer, MFR : Cable Manufacturer, MPS : Material Purchase Specification, P : Perform, W : Witness, V : Verification</b>												
3	Acceptance tests	g) Tensile strength & Elongation at break of insulation & outer sheath	Major	Physical	Each Lot Sample Basis	IS 7098/II/2011 & IS 5831/84	IS 7098/II/2011 & IS 5831/84	Test Report	-	P	W	
		h) Partial discharge test	Critical	Electrical		IS 7098/II/2011	IS 7098/II/2011	Test Report	-	P	W	
		i) High voltage test	Critical	Electrical		IS 7098/II/2011	IS 7098/II/2011	Test Report	-	P	W	
		j) Insulation resistance (Volume resistivity) test	Major	Electrical		IS 7098/II/2011	IS 7098/II/2011	Test Report	-	P	W	
		k) Tests for dimension of armour wires/strips	Major	Physical		IS 3975, IS 10810 Pt. 36 & Tech. Data sheet		Test Report	-	P	W	
		l) Test for anti termite & anti rodent property of outer sheath	Major	Physical		Tech. Data Sheet	Tech. Data Sheet	Reg./Sheet	-	P	W	
		m) Rewinding of cable on drum	Major	Visual		To check cable appearance, drum appearance, cable winding, packing, embossing/printing/sequential marking		Reg./Sheet	-	P	W	
		n) Void & contamination test for insulation (Silicon Oil test)	Major	Physical				Reg./Sheet	-	P	W	
		o) Wafer boil test for extruded semi-conducting layers	Major	Physical				Reg./Sheet	-	P	W	
		p) Freely Strippable insulation screen	Major	Physical		Factory Standard	Factory Standard	Test Report	-	P	W	
		q) Water Penetration test (WPT) on core (i.e. Logitudinal Water Blocking Test)	Major	Physical		IEC:60502	IEC:60502	Test Report	-	P	W	<b>Test shall be conducted for leakage of water through conductor.</b>
		r) Armour coverage	Major	Physical		As per data sheet & FS	As per data sheet & FS	Test Report	-	P	W	
		s) Ovality	Major	Physical		As per data sheet	As per data sheet	Test Report	-	P	W	
		t) Eccentricity	Major	Physical		As per data sheet	As per data sheet	Test Report	-	P	W	
		u) Mass & uniformity & zinc coating on armour	Major	Physical		As per data sheet & FS	As per data sheet & FS	Test Report	-	P	W	
		v) Resistivity of Strip armour	Major	Electrical		As per data sheet & FS	As per data sheet & FS	Test Report	-	P	W	
		w) Swelling height of water swellable tape	Major	Physical		As per data sheet & FS	As per data sheet & FS	Test Report	-	P	W	
		x) Flammability test	Major	Physical		As per IS-78098/II/2011	As per IS-78098/II/2011	Test Report	-	P	W	
y) Impulse withstand test	Critical	Electrical	IS 7098/II/2011	IS 7098/II/2011	Test Report	-	P	W				



**ANNEXURE G : QUALITY ASSURANCE PLAN (QAP)**

**FOR 11 kV H. T. CABLES**

S. NO.	COMPONENT & OPERATION	CHARACTERISTICS	CLASS	TYPE OF CHECK	QUANTUM OF CHECK	REFERENCE DOCUMENT	ACCEPTANCE NORMS	FORMAT OF RECORD	AGENCY			Remark	
									SV	MFR	BSES		
1	2	3	4	5	6	7	8	9	10	11	12	13	
<b>Legend : SV : Sub-Vendor of Cable Manufacturer, MFR : Cable Manufacturer, MPS : Material Purchase Specification, P : Perform, W : Witness, V : Verification</b>													
		z) Ageing & Water absorption test(Gravimetric) on Insulation & Outer sheath	Major	Physical		IS 5831/84	IS 5831/84	Test Report	-	P	W		
		z1) Heating Cycle with Potential	Critical	Electrical	sample basis, once per PO			Test Report	-	P	W		
		z2) Raw Material Verification in all aspects	Major	Physical	Each Lot					P	W		
		Z3) OFC Continuty Test and verification of outer sheath marking with continuous 15mm red strip for OFC embedded identification	Major	Physical	Each Lot					P	W		
4	Type tests at vendor's works	a) Tests on conductor											
		i) Annealing test for copper	Major	Physical		IS 8130/84	IS 8130/84	-	-	P	V	Verification of process records. Tests N/A on finished conductor.	
		ii) Tensile test for aluminium	Major	Physical		IS 8130/84	IS 8130/84	-	-	P	V		
		iii) Wrapping test for aluminium	Major	Physical		IS 8130/84	IS 8130/84	-	-	P	V		
		iv) Conductor resistance test	Major	Electrical			IS 8130/84	IS 8130/84	Test Report	-	P	V	
		b) Tests for armouring wires/strips											
		i) Dimensions of wire/strip	Major	Physical			IS 3975, IS 10810 Pt. 36 & Tech. Data sheet		Test Report	-	P	W	
		ii) Tensile strength & Elongation at break	Major	Physical			IS 3975	IS 3975	Test Report	-	P	W	Only for Steel wires/strips
		iii) Torsion test for wire	Major	Physical			IS 3975	IS 3975	Test Report	-	P	W	
		iv) Winding test for strip	Major	Physical			IS 3975	IS 3975	Test Report	-	P	W	
		v) Uniformity of zinc coating	Major	Chemical			IS 3975	IS 3975	Test Report	-	P	W	
		vi) Mass of zinc coating	Major	Chemical			IS 3975	IS 3975	Test Report	-	P	W	
		vii) Resistivity of wire/strip	Major	Electrical			IS 3975	IS 3975	Test Report	-	P	W	
		c) Test for thickness of insulation & sheath	Major	Physical			IS 7098/II/2011 & Tech. Data sheet	IS 7098/II/2011 & Tech. Data sheet	Test Report	-	P	W	
		d) Physical tests for insulation											W
		i) Tensile strength & Elongation test	Major	Physical			IS 7098/II/2011	IS 7098/II/2011	Test Report	-	P	W	
		ii) Ageing in air oven	Major	Physical			IS 7098/II/2011	IS 7098/II/2011	Test Report	-	P	W	
		iii) Hot set test	Major	Physical			IS 7098/II/2011	IS 7098/II/2011	Test Report	-	P	W	
		iv) Shrinkage test	Major	Physical			IS 7098/II/2011	IS 7098/II/2011	Test Report	-	P	W	
		v) Water absorption (gravimetric)	Major	Physical			IS 7098/II/2011	IS 7098/II/2011	Test Report	-	P	W	
e) Physical tests for outer sheath											W		

One sample per Tender



**ANNEXURE G : QUALITY ASSURANCE PLAN (QAP)**

**FOR 11 kV H. T. CABLES**

S. NO.	COMPONENT & OPERATION	CHARACTERISTICS	CLASS	TYPE OF CHECK	QUANTUM OF CHECK	REFERENCE DOCUMENT	ACCEPTANCE NORMS	FORMAT OF RECORD	AGENCY			Remark
									SV	MFR	BSES	
1	2	3	4	5	6	7	8	9	10	11	12	13
<b>Legend : SV : Sub-Vendor of Cable Manufacturer, MFR : Cable Manufacturer, MPS : Material Purchase Specification,  P : Perform, W : Witness, V : Verification</b>												
		i) Tensile strength & Elongation test at break	Major	Physical		IS 5831/84	IS 5831/84	Test Report	-	P	W	
		ii) Ageing in air oven	Major	Physical		IS 5831/84	IS 5831/84	Test Report	-	P	W	
		iii) Shrinkage test	Major	Physical		IS 5831/84	IS 5831/84	Test Report	-	P	W	
		iv) Hot deformation test	Major	Physical		IS 5831/84	IS 5831/84	Test Report	-	P	W	
		v) Loss of mass in air oven	Major	Physical		IS 5831/84	IS 5831/84	Test Report	-	P	W	
		v) Heat shock test	Major	Physical		IS 5831/84	IS 5831/84	Test Report	-	P	W	
		vi) Thermal stability test	Major	Physical		IS 5831/84	IS 5831/84	Test Report	-	P	W	
		f) Electrical tests in sequence									W	
		i) Partial discharge test	Critical	Electrical		IS 7098/II/2011	IS 7098/II/2011	Test Report	-	P	W	
		ii) Bending test	Major	Physical		IS 7098/II/2011	IS 7098/II/2011	Test Report	-	P	W	
		iii) Partial discharge test	Critical	Electrical		IS 7098/II/2011	IS 7098/II/2011	Test Report	-	P	W	
		iv) Dielectric power factor as a function of voltage	Major	Electrical		IS 7098/II/2011	IS 7098/II/2011	Test Report	-	P	W	
		v) Dielectric power factor as a function of temperature	Major	Electrical		IS 7098/II/2011	IS 7098/II/2011	Test Report	-	P	W	
		vi) Heating cycle test	Major	Electrical		IS 7098/II/2011	IS 7098/II/2011	Test Report	-	P	W	
		vii) Dielectric power factor as a function of voltage	Major	Electrical		IS 7098/II/2011	IS 7098/II/2011	Test Report	-	P	W	
		viii) Partial discharge test	Critical	Electrical		IS 7098/II/2011	IS 7098/II/2011	Test Report	-	P	W	
		ix) Impulse withstand test	Critical	Electrical		IS 7098/II/2011	IS 7098/II/2011	Test Report	-	P	W	
		x) High voltage test	Critical	Electrical		IS 7098/II/2011	IS 7098/II/2011	Test Report	-	P	W	
		g) Insulation resistance (Volume resistivity test)	Major	Electrical		IS 7098/II/2011	IS 7098/II/2011	Test Report	-	P	W	
		h) Flammability test	Major	Physical		IS 7098/II/2011	IS 7098/II/2011	Test Report	-	P	W	
<b>D PACKING &amp; MARKING</b>												
1	Packing & Marking	a) Cable end sealing	Major	Visual	100 %	IS 7098/II/2011/ Agreement	IS 7098/II/2011/ Agreement	-	-	P	W/V	BSES representative may verify these characteristics on randomly selected drums.
		b) Pulling eye at leading end- removed from vendor scope, end cap shall be provided at both the end of cable	Major	Visual	100 %	As per agreement	As per agreement	-	-	P	W/V	
		b) Stencilling/Marking on drum	Minor	Visual	100 %	IS 7098(Part 2):2011/ Agreement	IS 7098(Part 2):2011/ Agreement	-	-	P	V	



## ANNEXURE G : QUALITY ASSURANCE PLAN (QAP)

### FOR 11 kV H. T. CABLES

S. NO.	COMPONENT & OPERATION	CHARACTERISTICS	CLASS	TYPE OF CHECK	QUANTUM OF CHECK	REFERENCE DOCUMENT	ACCEPTANCE NORMS	FORMAT OF RECORD	AGENCY			Remark
									SV	MFR	BSES	
1	2	3	4	5	6	7	8	9	10	11	12	13
<b>Legend : SV : Sub-Vendor of Cable Manufacturer, MFR : Cable Manufacturer, MPS : Material Purchase Specification,</b>												
<b>P : Perform, W : Witness, V : Verification</b>												
<b>Note</b>	<ol style="list-style-type: none"><li>1. Checks specified above for Raw Material, In-Process and Final Inspection shall be as relevant to the specific cable construction.</li><li>2. Number of samples shall be selected as per Factory Standard/Agreement wherever 'sample' is indicated for extent of check.</li><li>3. Plant standards shall be followed in case Technical Data Sheet does not include requirements for characteristics to be checked.</li><li>4. BSES may witness Raw material and in process inspection in addition to Routine/Acceptance tests at any time/stage of manufacturing.</li><li>5. BSES's Inspector may randomly select a cable drum for type testing at vendor's works.</li><li>6. For each of the offered lot for inspection, BSES may randomly select one cable drum for testing of end cap "Destructive testing" to verify adhesion of sealing cap to cable outer sheath. .</li><li>7. All factory Type Tests shall be Witnessed by BSES</li></ol>											

**Annexure- H****Testing and manufacturing process requirements w. r. t. TR- XLPE insulation**

All cables made with TR-XLPE Insulation should be tested and/or certified to meet the following performance parameters as per ANSI /ICEA S-94-649 after one year AWTT.

Property	Units	Requirements Values
Min. Avg. Electrical Breakdown Strength(qual. test)	kV/mm	$\geq 25$
Impulse Strength	kV/mm	$\geq 83$
Water Tree Length	Mm	0.25
Max. Bowtie Tree Density	(Number per 16.4 cu. cm)	Maximum 15 (0.12-0.25 mm range)

Manufacturing processes to produce high-quality cables with the following characteristics:

- Cure consistency with hot set/creep less than 100%
- No voids larger than 75 microns per 16.4 cubic cm
- No ambers larger than 250 microns per 16.4 cubic cm
- No contaminants larger than 125 microns and less than 5 between 50-125 microns per cubic 16.4 cubic cm tested.
- Neutral indent on cable is less than 375 microns
- Cable insulation concentricity greater than 90% tested
- No protrusions greater than 75 microns at the conductor shield and 125 microns at the insulation shield

**Annexure-I: Deviation Format**

Sl. No.	Document Name	Clause No.	Deviation	Reason	Merit to BSES

# BSES

BSES-TS-158-RMHC-R0

APPROVED LIST FOR DIFFERENT TYPES OF CABLE RAW MATERIALS & VENDOR NAMES

# BSES

APPROVED LIST

FOR

DIFFERENT TYPES OF CABLE RAW MATERIALS &

VENDOR NAMES

Specification No.- BSES-TS-158-RMHC-R0

Rev:	R0	Page:	03
Date:	16.05.2024		
Prepared by	RK Jana/ Pronab Bairagi	<i>R.K. Jana</i> <i>20.05.24</i>	<i>[Signature]</i>
	Abhishek Vashistha	<i>Abhishek</i>	
Reviewed by	Amit Tomar		<i>[Signature]</i>
	Puneet Duggal	<i>PD</i>	
Approved by	Gaurav Sharma	<i>Gaurav</i>	
	Gopal Nariya	<i>[Signature]</i>	



**Raw materials Manufacturer details :**

SL.NO.	RAW MATERIALS	SL.NO.	NAME OF MAKE
01	Aluminium Rod (For conductor & armour)	A	Bharat Aluminium Co.Ltd. (BALCO)
		B	Hindustan Aluminium Co.Ltd. (HINDALCO)
		C	National Aluminium Co.Ltd.(NALCO)
		D	Vedanta (Sesa Sterlite)
02	Water-Swellable Tapes (Pre-slitted)	A	Lantor
		B	GECA TAPES
		C	Scapa
		D	Sneham International
		E	Indore Tapes
03	Semi-Conducting Compound	A	Dow Chemical, U.S.A.
		B	Borealis, Sweden
		C	Hanwha, South Korea
04	XLPE Compound	A	Dow Chemical, U.S.A.
		B	Borealis, Sweden
		C	Hanwha, South Korea
05	Water-Blocking Tapes / Yarn	A	Lantor
		B	Geca Tapes
		C	Scapa
		D	Sneham International
		E	Indore Tapes
06	Copper Tape	A	Aggarwal Metal
		B	Neosym Industry
		C	Luvata , Swedan
07	Core Identification	A	AVSL Industries
		B	Yash Polymer

**APPROVED LIST FOR DIFFERENT TYPES OF CABLE RAW MATERIALS & VENDOR NAMES**

	Tape	C	Vijay Polymers
08	P. P. Fillers	A	AVSL Industries
		B	Yash Polymer
		C	Vijay Polymers
09	PVC Compound	A	Ddev Plastiks Industries Ltd.
		B	Universal
		C	SCJ Plastic
		D	Sriram Polytech
		E	Shri Ram Vinyl, Kota
		F	Bansal Polyplast Pvt.Ltd.
		G	KEI Industries Ltd.
		H	KEC International Ltd.
10	Galvanized Steel Wires / Strips	A	TATA
		B	Balaji
		C	Systematic
		D	Mica Wires Pvt.Ltd
		E	Bansal Industries
11	PE Compound	A	Borealis
		B	Shakun
		C	Ddev Plastiks Industries Ltd.

**Note:**

- A. Listed make in this documents shall be followed by manufacturer strictly.
- B. Deviation shall not be given for raw material make at any stage of manufacturing.