



BSES Rajdhani Power Ltd.

BSES RAJDHANI POWER LTD (BRPL)

Notice Inviting Tender (NIT)

for

Scheme No: EW22GS4011 for LILO of 66kV Tikari Kalan (Mundka) - Nilothi Grid Ckt
1 & 2 at New Proposed Cable Lying for 66kV Bakkarwala Grid.

NIT No: CMC/BR/25-26/FK/CR/AG/1237

Dated: 16.01.2025

Due Date for Submission of Tender: 06.02.2025, 15:30 HRS

Date and Time of opening: 06.02.2025, 15:45 HRS

BSES RAJDHANI POWER LIMITED,

BSES Bhawan, Nehru Place, New Delhi – 110019.

Corporate Identification Number: U74899DL2001PLC111527

Website : www.bsesdelhi.com

(This document is meant for the exclusive purpose of bidding against this NIT Number /Specification and shall not be transferred, reproduced, or otherwise used for purposes other than that for which it is specifically issued).

CONTENTS

S.No.	ITEM	DISCRIPTION
1	CHECK LIST	CHECK LIST FOR BID SUBMISSION
2	SECTIONS	
2.1	SECTION-I	REQUEST FOR QUOTATION (RFQ)
2.2	SECTION-II	INSTRUCTION TO BIDDERS (ITB)
2.3	SECTION-III	SPECIAL CONDITIONS OF CONTRACT (SCC)
2.4	SECTION-IV	GENERAL CONDITIONS OF CONTRACT (GCC)
2.5	SECTION-V	SCOPE OF WORK
2.5	SECTION-VI	ESTIMATED QUANTITY
2.6	SECTION-VII	PRICE BID
3	ANNEXURES	
3.1	ANNEXURE-I	BID FORM
3.2	ANNEXURE-II	BIDDER'S DETAILS
3.3	ANNEXURE-III	ACCEPTANCE OF REVERSE AUCTION
3.4	ANNEXURE-IV	ENVIRONMENTAL, OCCUPATIONAL HEALTH & SAFETY CONDITIONS OF CONTRACT
4	FORMATS	
4.1	EMD	EARNEST MONEY DEPOSIT (EMD) BANK GUARANTEE
4.2	CPBG	CONTRACT CUM PERFORMANCE BANK GUARANTEE (CPBG)
4.3	NDA	NON-DISCLOSURE AGREEMENT (NDA)
4.4	NDD	NO DEVIATION DECLARATION (NDD)
4.5	COMMUNICATION	BIDDER'S COMMUNICATION DETAILS

INDEX

SECTION- I REQUEST FOR QUOTATION (RFQ)	8
1. GENERAL.....	9
2. POINTS TO BE NOTED	9
3. EMD.....	10
4. QUALIFYING REQUIREMENTS (QR)	10
1.1 (A.1) TECHNICAL QR:	11
5. PRE-BID MEETING:.....	13
6. BID SUBMISSION	13
6. TIME SCHEDULE.....	14
7. AWARD DECISION	15
8. MARKET INTEGRITY.....	15
9. CONFIDENTIALITY	16
10. CONTACT INFORMATION	16
SECTION-II : INSTRUCTIONS TO BIDDERS (ITB).....	17
1. GENERAL.....	18
2. SCOPE OF WORK.....	18
3. DISCLAIMER.....	18
4. COST OF BIDDING.....	19
5. TENDER DOCUMENTS.....	19
6. AMENDMENT OF TENDER DOCUMENTS.....	19
7. PREPARATION OF BIDS & LANGUAGE	20
8. DOCUMENTS COMPRISING THE BID	20
9. BID FORM	20
10. BID PRICES	20
11. BID CURRENCIES.....	20
12. PERIOD OF VALIDITY OF BIDS.....	20
13. ALTERNATIVE BIDS.....	20
14. FORMAT AND SIGNING OF BID	20
15. SEALING AND MARKING OF BIDS.....	21
16. DEADLINE FOR SUBMISSION OF BIDS.....	21
17. ONE BID PER BIDDER	21
18. LATE BIDS	21
19. MODIFICATIONS AND WITHDRAWAL OF BIDS	21
20. EVALUATION OF BID	21

21.	CLARIFICATION OF BIDS	21
22.	PRELIMINARY EXAMINATION OF BIDS / RESPONSIVENESS.....	22
23.	EVALUATION AND COMPARISON OF BIDS.....	22
24.	CONTACTING THE COMPANY.....	22
25.	COMPANY'S RIGHT TO ACCEPT ANY BID AND TO REJECT ANY OR ALL BIDS	23
26.	AWARD OF CONTRACT.....	23
27.	THE COMPANY'S RIGHT TO VARY QUANTITIES.....	23
28.	LETTER OF INTENT/ NOTIFICATION OF AWARD.....	23
29.	CORRUPT OR FRAUDULENT PRACTICES	23
30.	PROCESS TO BE CONFIDENTIAL	24
SECTION – III : SPECIAL CONDITIONS OF CONTRACT (SCC)		25
1.	DEFINITIONS.....	35
ENGINEER IN-CHARGE (EIC) / OFFICER-IN-CHARGE (OIC).....		35
2.	SCOPE OF WORK.....	35
3.	EFFECTIVE DATE, TIME AND VALIDITY.....	35
3.1	35	
4.	ORDER VALUE.....	35
5.	RATES & ESCALATION.....	35
6.	CONTRACT CUM PERFORMANCE SECURITY BANK GUARANTEE (CPBG)	
	36	
7.	PAYMENT TERMS.....	37
8.	PENALTY	37
9.	DERC GUIDELINES & REGULATIONS.....	38
10.	INSURANCE POLICIES.....	38
11.	WARRANTY / DEFECT LIABILITY PERIOD.....	39
12.	QUALITY:	39
13.	WORK COMPLETION CERTIFICATION, HANDING OVER AND MATERIAL RECONCILIATION:	39
14.	COMPLETION PERIOD:	40
15.	GUIDELINES REGARDING INSPECTION & MAINTENANCE OF PITS /DUG AREA WHILE DOING WORK AT SITE IN BRPL AREA.....	40
SECTION – IV : GENERAL CONDITIONS OF CONTRACT (GCC).....		41
1.	DEFINITION & INTERPRETATION.....	42
2.	PRIORITY OF CONTRACT DOCUMENTS.....	44
3.	AMENDMENT.....	45



BSES Rajdhani Power Ltd.

4.	LANGUAGE AND MEASUREMENT	45
5.	EXAMINATION OF SITE & LOCAL CONDITIONS.....	45
6.	TAXES & DUTIES	45
7.	PAYMENT	46
8.	TAX INVOICE SUBMISSION PROCEDURE AND CERTIFICATION.....	46
9.	TIME ESSENCE OF CONTRACT	46
10.	NOT USED	47
11.	INSPECTION & QUALITY CONTROL.....	47
12.	REPORTS AND INFORMATION.....	47
13.	STATUTORY OBLIGATIONS.....	47
14.	REPRESENTATION, WARRANTIES AND GUARANTEES.....	48
15.	EVENTS OF DEFAULTS.....	48
16.	RISK & COST	49
17.	LIMITATION OF LIABILITY	49
18.	TERMINATION.....	49
19.	GOVERNING LAW AND ARBITRATION.....	50
20.	FORCE MAJEURE	50
21.	NOTICE & COMMUNICATION.....	52
22.	SAFETY CODE	52
23.	CONTRACTOR'S OBLIGATIONS	53
24.	INDEMNITY	54
25.	SECREC Y & CONFIDENTIALITY	54
26.	NON-EXCLUSIVITY	54
27.	SEVERABILITY	55
28.	ASSIGNMENT & SUBLETTING	55
29.	ASSIGNMENT BY THE COMPANY	55
30.	NO JOINT VENTURE	55
31.	WAIVER OF RIGHTS	55
32.	THE COMPANY'S RIGHT TO VARY QUANTITIES	55
33.	VENDOR CODE OF CONDUCT	55
34.	DISCLOSURE OF RELATIONSHIP	55
35.	MSME	56
36.	COVID GUIDELINES.....	56
37.	CLEANLINESS & PRECAUTIONS TO BE TAKEN WHILE DOING WORK AT SITE TO PREVENT DUST POLLUTION.....	56
38.	ENVIRONMENTAL, HEALTH & SAFETY	57

39. ACCEPTANCE	59
SECTION – V :SCOPE OF WORK.....	60
SECTION – VII: PRICE BID	64
ANNEXURE – I :BID FORM	72
ANNEXURE – II: BIDDER’S DETAILS	73
ANNEXURE – III :ACCEPTANCE FORM FOR PARTICIPATION IN REVERSE AUCTION EVENT	76
ANNEXURE – IV:ENVIRONMENTAL, OCCUPATIONAL HEALTH & SAFETY CONDITIONS OFCONTRACT.....	77
SECTION – VIII: TECHNICAL SPECIFICATION.....	96

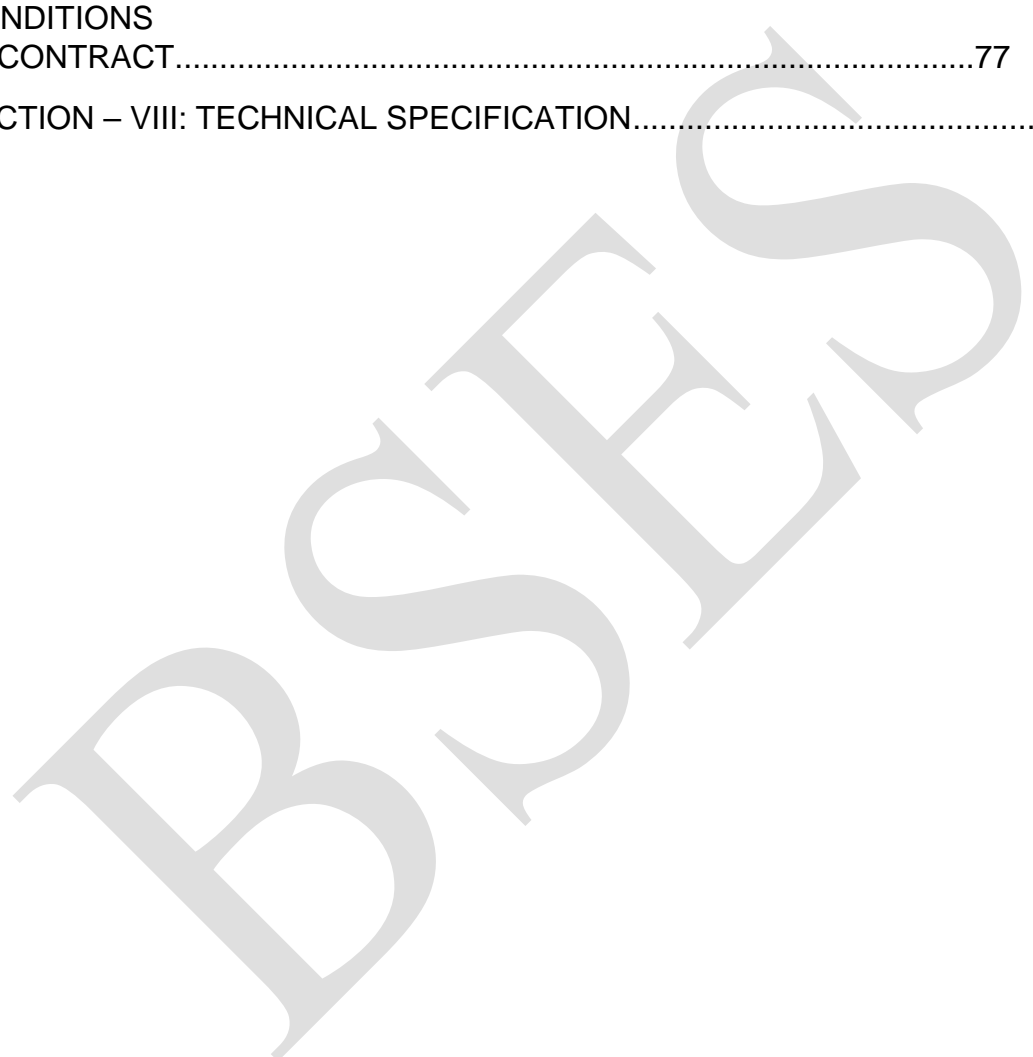

CHECK LIST**(FOR BID SUBMISSION)**

S. No	Item Description	Y/N
1	BID INDEX	
2	COVERING LETTER	
3	TENDER FEE	
4	EARNEST MONEY DEPOSIT	
5	POWER OF ATTORNEY	
6	BID FORM DULY SIGNED	
7	NON-DISCLOSURE AGREEMENT (NDA)	
8	NO DEVIATION DECLARATION (NDD)	
9	UNPRICED TECHNO-COMMERCIAL BID (IN SEPARATE SEALED ENVELOPE-1)	
10	PRICE BID (IN SEPARATE SEALED ENVELOPE-2)	
11	COMPLETE BID DOCUMENTS, ENVELOPE 1 & 2 (IN SEPARATE SEALED ENVELOPE-3)	

SECTION- I REQUEST FOR QUOTATION (RFQ)

BSES

SECTION-I REQUEST FOR QUOTATION (RFQ)

1. GENERAL

BSES Rajdhani Power Limited invites sealed tenders on a "Single Stage: Two Envelope" bidding basis (Envelope –I, Techno-Commercial Bid & Envelope-II, Price Bid) from eligible Bidders for Scheme No: EW22GS4011 for LILO of 66kV Tikari Kalan (Mundka) - Nilothi Grid Ckt 1 & 2 at New Proposed Cable Lying for 66kV Bakkarwala Grid.

The bidder must qualify the requirements as specified in heading "Qualifying Requirements" of this RFQ.

- 1.1. The sealed envelopes shall be duly super-scribed as:

"NIT No.: CMC/BR/25-26/FK/CR/AG/1237 Dated: 16.01.2025"

for

Scheme No: EW22GS4011 for LILO of 66kV Tikari Kalan (Mundka) - Nilothi Grid Ckt 1 & 2 at New Proposed Cable Lying for 66kV Bakkarwala Grid.

Schedule of the tendering process is given below. Detailed Specification, Scope of Work, Terms & Conditions, etc are mentioned in the Tender documents, which is available on our website.

Cost of Tender Documents (Non- Refundable)	Rs. 1180/- (including GST)
Estimated cost of work	Rs. 1.81 Crores
Earnest money Deposit	Rs. 3.62 Lakhs
Work to be completed by	15 th May 2025
Tender documents on sale	16/01/2025 to 06/02/2025 (Working days)
Date & time of Submission of Bid	06.02.2025 till 15:30 HRS
Date & time of opening of Techno-Commercial Bid	06.02.2025 at 15:45 HRS

- 1.2. The tender document can be obtained from address given below against submission of non-refundable demand draft of **Rs. 1180/-** drawn in favour of BSES Rajdhani Power Ltd, payable at Delhi:

Head of Department
Contracts & Material Dept.
BSES Rajdhani Power Limited
1st Floor, "C" Block, BSES Bhawan
Nehru Place, New Delhi -110019.

- 1.3. Only DD shall be accepted for tender fees.
- 1.4. The tender documents will be issued on all working days up to the date mentioned in clause 1.3. The tender documents & detail terms and conditions can also be downloaded from the website www.bsedelhi.com. In case tender documents are downloaded from the above website, then the bidder has to enclose a separate demand draft covering the cost of bid documents.

2. POINTS TO BE NOTED

- 2.1. Works envisaged under this contract are required to be executed in all respects up to the period of completion/ duration of work mentioned above.

BSES Rajdhani Power Ltd.

- 2.2. Only those agencies, who fulfil the qualifying criteria as mentioned in clause 3 should submit the tender documents.
- 2.3. BSES RAJDHANI Power Ltd reserves the right to accept/reject any or all bids without assigning any reason thereof and alter/amend/modify/add/reduce the amount and quantity mentioned in the tender documents at the time of placing Order
- 2.4. The bid will be summarily rejected if:
 - (a) **Earnest Money Deposit (EMD)** and **Tender Fee** of requisite amount is not deposited as per tender conditions
 - (b) Bid received after due date and time.

3. EMD

- 3.1. The bidder shall furnish, as part of its bid, an EMD of the requisite amount. The EMD is required to protect the Company against the risk of Bidder's conduct which would warrant forfeiture. The EMD shall be denominated in any of the following forms:
 - (a) BG from nationalized / Scheduled Bank, as per the format annexed in the tender document, in favour of BSES Rajdhani Power Limited valid for 6(six) months from original due date of bid submission.
 - (b) Fixed Deposit (lien marked in favor of BSES RAJDHANI POWER LTD) valid for 6(six) months from original due date of bid submission.
- 3.2. Please note that bank details as given below have been provided only for the purpose of making BG for EMD.

Beneficiary Name	: BSES Rajdhani Power Limited
Bank Name	: State Bank of India
A/c No.	: 40214783615
IFSC Code	: SBIN0009601

The EMD of the bidders who are not technically qualified shall be returned after the price bid opening.
- 3.3. Earnest money given by all the bidders who are techno commercially qualified except the lower bidder shall be returned within 8 (Eight) weeks after award of the work.
- 3.4. The EMD of the successful bidder shall be returned on submission of CPBG as per tender terms.
- 3.5. The EMD may be forfeited in case of:
 - (a) The Bidder withdraws its bid during the period of bid validity specified by the Bidder in the Bid Form or
 - (b) The successful Bidder does not
 - (i) Accept the Purchase Order/Work Order, or
 - (ii) Furnish the required CPBG as per tender terms
 - (c) The bidder is found to have submitted false or forged, any of the documents/certificates/information.

4. QUALIFYING REQUIREMENTS (QR)

The prospective bidder must meet all of the following qualifying requirements to be eligible to participate in the bidding.

1.1 (A.1) TECHNICAL QR:

- a. Bidder must provide experience certificate of having successfully laid of cumulative 10 KM cable of rating 33 KV, 3C XLPE Power Cables or higher voltages preferably for electric utilities/ SEBs / Discoms /Govt. organizations/Reputed private organizations/ OEM/other govt. organizations during the last ten years and out of which minimum laid of 5 KM cable in last 5 financial years in Delhi/NCR area or any other area in India.
- b. The bidder must enclose order copies along with performance certificates in support of relevant experience. Experience credential as a joint venture / subcontract/ consortium will not be considered.
- c. For Existing vendors of BRPL, following aspects will be taken into account while carrying out technical evaluation for qualification of bids:
 - 1) Performance of bidders measured by Engineer In Charge in earlier executed works of EHV.
 - 2) Complaint of external bodies (Court, Police, Govt Departments, other statutory bodies etc.) for offences by the bidder in earlier executed EHV works.
 - 3) Ability of bidder (in terms of availability of resources such as supervisory and execution manpower, T&P etc.) to simultaneously execute at a time multiple works (more than 2 EHV projects).
- d. Bidders should have basic testing equipments like PC Set, Sheath Fault measurement Kit etc available with his company & shall submit the list of tools & tackles, with SI No, Make & Calibration certificates suitable for carrying out the specified job tendered for.

Please note: For Existing vendors of BRPL, Technical evaluation will also include the performance in the existing contracts. BRPL reserves the right to qualify or disqualify their bid based on the performance in spite of them meeting the above qualifying criteria.

(A.2) Commercial Qualifying Criteria:

- a) The average annual turnover of the Bidder, in the preceding three (3) financial years (i.e., FY23-24, FY22-23 & FY21-22) should not be less than Rs 3 Crores (Three crores). The bidder shall submit the Annual Turnover Report of the last 3 FYs duly certified by a Chartered Accountant. The Turnover certificate must have UDIN Number.
- b) The bidder must provide proof of having solvency of an amount equal to Rs 0.50 Crore from any nationalized/ scheduled commercial bank. It should not be older than 30.06.2024.
- c) Bidder should have Registration of GST & PAN.
- d) Bidder should fulfil all statutory compliances like PF, ESI registration.
- e) The bidder should possess valid Electrical Contractor License issued by competent statutory agency to undertake work in NCT Delhi. In case the bidder is not having this license, they have to give the undertaking that it will be obtained by them before the start of the work at site or suitable sub-contractor having the valid license shall be engaged for works at site with the approval of BRPL where copy of valid license shall be submitted to BRPL before the start of the work.
- f) Entities that have been currently debarred/blacklisted by any Private/central/state government institution including electricity boards in India, any of the DISCOM in India, lacks qualifying pre-requisites to participate in this tender will not be considered. Accordingly, an undertaking by the Authorized Person along with other documents to be provided by the bidder on its letterhead in this regard, confirming in clear terms, that the contractor has not been debarred/blacklisted as on the date of submission of the bid. Bidders who is currently debarred/ blacklisted/ suspended by BRPL will not be considered in this tender.
- g) The bidder should give an undertaking on their letterhead that all the documents/certificates/information submitted by them against the tender are genuine/true/correct and the copies of documents have been made from the original document/s. Further, in case any of the documents/certificates/information submitted by the bidder is found to be false or, BRPL at its sole discretion shall be free to take all

actions as permitted under law, including forfeiture of EMD and disqualification from participation in the future tenders of BRPL & Its group companies for an indefinite period or period as may be decided by BRPL.

- h) The bidder should submit an undertaking for “No Litigation” / no legal case is pending with BRPL or its Group Companies. Bidders having any litigation/ legal case pending with BRPL shall not be considered qualified for this tender.

OTHER REQUIREMENTS:

- a. Company reserves the right to carry out technical capability/ infrastructure assessment of the Bidders by factory/office/site inspection or by any other means and company's decision shall be final in this regard.
- b. No Joint ventures / consortiums are allowed.
- c. The bidder shall submit all necessary documentary evidence to establish that the Bidder meets the above qualifying requirements including but not limited to the following:
- d. Last three Financial Years (FY23-24, FY22-23 & FY21-22) audited financial statement.
 - i. Bidder to submit UDIN based CA Certificate showing NIL dues towards Statutory Liabilities, including GST, Taxation, PF, ESI, or any other dues Statutory in nature for the period upto 31.03.2024, herein collectively called as “Statutory dues” and there is no liability over the bidder relating to deposition of such statutory dues.
 - ii. Detail of Banks and Fund & Non fund based Credit limit
 - iii. Details of formation/registration of the firm (Proprietary/ Partnership) or Company along with all relevant details)
 - iv. Memorandum & Articles of Association of the Company/ Partnership Deed of the Firm /other registration documents, as applicable
 - v. Organization Chart of the Bidders Company/organization
 - vi. Organization chart for execution of the contract
 - vii. Experience details with credentials
 - viii. Number of Employees & necessary details
 - ix. Details of office/s in Delhi, Details of Registered and Corporate offices and details of other offices/establishments in India.
 - x. Work order / Agreement copies along with performance certificates in support of relevant experience.
 - xi. Turnover certificate issued by CA (along with UDIN no.) for the last three Financial Years.
 - xii. Net worth certificate as elaborated in financial QR
 - xiii. List of pending litigation with government/other institution on account of executing any order.
 - xiv. Copy of ESI/PF Registration certificate
 - xv. Copy of PAN/GST no.
 - xvi. Copy of GST Return of last Financial Year.
 - xvii. Copy of valid Electrical License
 - xviii. Non-Disclosure Agreement (NDA) as per format attached
 - xix. Bidder's details as per format attached
 - xx. Solvency Certificate
 - xxi. An undertaking to provide all Tools & Plants , PPEs as per tender scope
 - (a) The bidder should enclose performance certificates in support of relevant experience.
 - (b) For Existing vendors of BRPL, the evaluation will also include the performance in the existing contracts via-a-vis performance in terms of HR issues, all statutory Compliance parameters and wages disbursement by Vendors. BRPL reserves the right to qualify or disqualify their bid based on the contract performance despite them meeting the above-mentioned qualification requirements. In case of bidder has a previous association with BRPL/BYPL for similar product and service, the performance feedback for that bidder by

BRPL/BYPL shall only be considered irrespective of performance certificate issued by any third organization.

- (c) BRPL may ask for such other documents as it deems fit for substantiating/ justifying the submissions made by the bidder.

5. PRE-BID MEETING:

A pre-Bid meeting shall be organised physically or digitally (through web conferencing platform) at the time and date as specified in the tender documents in the presence of those bidders or their authorized representatives who may choose to be present.

The details of the Pre Bid Meeting are given below: -

Tender description	Pre Bid Date	time	Venue
Scheme No: EW22GS4011 for LILO of 66kV Tikari Kalan (Mundka) - Nilothi Grid Ckt 1 & 2 at New Proposed Cable Lying for 66kV Bakkarwala Grid.	29-01-2025	3:00 PM	BSES-NHP Office

All queries related to this tender must reach to C&M Department of BRPL at least three days before the date of the pre- bid meeting. All the bidder's queries shall be replied to in the pre-bid meeting. In case any change is required in the tender document the same shall be affected in the form of corrigendum to this tender. The bidder or their representatives who intend to bid and who have either purchased tender documents or will pay tender fees for downloaded documents are invited to attend the pre-bid meeting. Corrigendum, if any, to the tender document shall be hosted on the website subsequent to the pre-bid meeting. Bidders are requested to submit their offer strictly in line with this tender document & corrigendum if any.

6. BID SUBMISSION

- 6.1. The bidders are required to submit the bid in 2 (two) parts and in original & duplicate (total 2 copies) at the following address:

**Head of Department,
Contracts & Material Department,
BSES Rajdhani Power Limited,
1st Floor, "C" Block, BSES Bhawan,
Nehru Place,
New Delhi-110019.**

- 6.2. Technical bid documents along with commercial terms and conditions shall also be submitted in Pen Drive. No price bid shall be submitted in Pen Drive. The PEN Drive should be owned by Bidder. The bidder shall ensure that the Pen Drive is free from all viruses/malware. The pen drive once submitted shall not be returned.
- 6.3. This is a two part bid process. Bidders are to submit the bids in 2(two) parts. Both these parts should be furnished in separate sealed covers super scribing **NIT no. DUE DATE OF SUBMISSION, with particulars as PART-A Techno-Commercial Bid and Part-B PRICE BID** and these sealed envelopes should again be placed in another sealed envelope which should be super scribed with —"**Tender Notice No. & Due date of opening**". The same shall be submitted before the due date & time specified.

6.3.1 PART A: TECHNO-COMMERCIAL BID, UNPRICED (Envelop-1):

The first sealed envelope shall contain an Unpriced Techno-commercial bid in paper form (hard copies) and envelope super-scribing **PART-A Techno-Commercial Bid**. The details to be submitted in techno-commercial bids are given below:

- a) General information about bidder
- b) Documentary evidence in support of all the qualifying criteria as per clause 4.0,
- c) EMD of requisite amount
- d) Non-refundable separate demand draft for Rs. 1180/- In case the forms are downloaded from the website
- e) Technical Literature if any.
- f) Details of experience of works of the same or similar nature. Copy of work orders and performance certificates.
- g) Power of attorney
- h) Acceptance to Commercial Terms and Conditions viz Delivery schedule/period, Payment terms, BG etc
- i) Any other relevant document to support bidder meeting QR

Techno-Commercial Bid should not contain any cost information whatsoever and shall be submitted within the due date. After techno-commercial evaluation, the list of techno-commercially qualified bidders will be posted immediately on the BSES website.

The bidder should submit complete tender document along with all corrigendum (if any) published against this NIT at our website, signed and stamped with bidder's seal as an acceptance of all the terms & conditions of the Tender.

6.3.2 PART B: PRICE BID (Envelop-2):

The second sealed envelope shall contain Price bids in paper form (hard copies and envelope super-scribing **PART-B Price Bid** on it. The details to be submitted in the Price bid are given below:

- (a) **PRICE BID** shall Comprise of Prices **strictly** in the Format enclosed in SECTION VII. Any change in price bid format, content may lead to rejection of the bid.
- (b) Price Bid will be opened after techno-commercial evaluation of all the bids and only of the qualified bidders.

6.3.3 FINANCIAL BID EVALUATION THROUGH REVERSE AUCTION

Reverse Auction (RA) shall be conducted for finalization of contract and the details of the price bid shall not be shared with bidders. The qualified bidders will participate in reverse auction through SAP-SRM tool. The RA process shall be governed by the terms and conditions enclosed as Annexure-III in this tender document. Training/details shall be provided to bidders before participation in auction. In case RA is not conducted /concluded for any reasons, a "final no regret" financial bid in a sealed envelope will be called for from all qualified bidders. Notwithstanding anything stated above, the Company reserves the right to assess bidders' capability to perform the contract, should the circumstances warrant such assessment in the overall interest of the Company. In this regard, the decision of the Company shall be final and binding on the bidders.

7. TIME SCHEDULE

The activities and their timelines are given hereunder which needs to be adhered by the bidders.

S. No.	Activity	Description	Due date
1	Submission of Technical & Commercial Queries, if any	All Queries related to NIT	28/01/2025
2	Pre-Bid Meeting	Discussion on pre-bid queries	29/01/2025
3	Submission of Techno-Commercial & Price Bid	Unpriced Techno-Commercial & Price Bid in separate sealed envelopes	06/02/2025
4	Opening of Techno-Commercial Bid	Opening of PART-A	06/02/2025
5	Opening of Price Bid	Opening of PART-B of only the techno-commercially qualified bidders (List of bidders will be published at our website)	To be informed separately
6	Reverse Auction	As per RA terms	Schedule will be intimated to eligible bidders through email from email id: BRPL.Eauction@relianceada.com

8. AWARD DECISION

- 8.1 Company intends to award the business on a lowest bid basis, so bidders are encouraged to submit the bid competitively. The decision to place order/LOI solely depends on Company on the cost competitiveness across multiple lots, quality, delivery and bidder's capacity, in addition to other factors that Company may deem relevant.
- 8.2 The Company reserves all the rights to award the contract to one or more bidders who meet the execution requirement or nullify the award decision without assigning any reason thereof.
- 8.3 In case the performance of any contractor is found unsatisfactory during the execution process, the award will be cancelled and BRPL reserves the right to award the work to another contractor(s) who will be found eligible/fit.
- 8.4 The abnormally higher or abnormally lower bids shall not be considered with respect to estimated cost. The criteria decided by BRPL on this shall be final and binding on the bidders.
- 8.5 The bidding firms are advised to quote their Margin / Administrative Service Charges accordingly. BRPL reserves the right to reject the bids quoted with abnormally higher or abnormally lower individual activity rates. The criteria decided by BRPL on this shall be final and binding on the bidders and will not be open for discussion under any circumstances.

9 MARKET INTEGRITY

We have a fair and competitive marketplace. The rules for the bidders are outlined in the Terms & Conditions of the tender documents. Bidders must agree to these rules prior to participating in the tender. In addition to other remedies available, we reserve the right to exclude a bidder from participating in future markets due to the bidder's violation of any of the rules or obligations contained in the Terms & Conditions. Bidder(s) who violate the marketplace rules or engage in behaviour that disrupts the fair execution of the marketplace restricts a bidder from participation in future tenders of BRPL to a length of time as decided by BRPL, depending upon the seriousness of the violation. Examples of violations include, but are not limited to:

- Failure to honour prices submitted to the market place.

BSES Rajdhani Power Ltd.

- Breach of the terms published in Request for Quotation/NIT
- Misrepresentation of facts, submitting false and fabricating documents

10 CONFIDENTIALITY

All information contained in this tender document is confidential and may not be disclosed, published or advertised in any manner without written authorization from BRPL. This includes all bidding information submitted.

All tender documents remain the property of BRPL and all bidders are required to return these documents to BRPL upon request.

Bidder(s) who do not honour these confidentiality provisions will be excluded from participating in future bidding events.

The bidder shall sign a Non-Disclosure Agreement (NDA) in the format attached in tender document and submit along with its bid.

11 CONTACT INFORMATION

Technical & Commercial clarification, if any, regarding this tender shall be sought in writing and sent by e-mail to the following e-mail IDs:

Address	Name/ Designation	E-mail Address / Phone Number	
Technical			
Scheme No: EW22GS4011 for LILO of 66kV Tikari Kalan (Mundka) - Nilothi Grid Ckt 1 & 2 at New Proposed Cable Lying for 66kV Bakkarwala Grid.	Mr. Yogesh Kawale, GM	Yogesh.kawale@relianceada.com 08882691429	
	Mr. Nirjendu Pandey Head – EHV(P&C)	Nirjendu.Pandey@relianceada.com 011-49209323	
	Mr. Amit Tomar AsVP – (CES Team)	Amit.As.Tomar@relianceada.com 011-49207306	
	All technical queries shall also be marked copy to Commercial team as per the details below.		
	Commercial		
	C&M Dept, 1st Floor, C Block, BSES Rajdhani Power Ltd BSES Bhawan, Nehru Place, New Delhi – 110019.	Ms. Anima Gaur DGM-(Contracts) Mr. Amitava Nandi, AsVP – (Head Contracts)	anima.gaur@relianceada.com 011-49209429 Amitava.Nandi@relianceada.com 011-4920 9619

SECTION-II : INSTRUCTIONS TO BIDDERS (ITB)

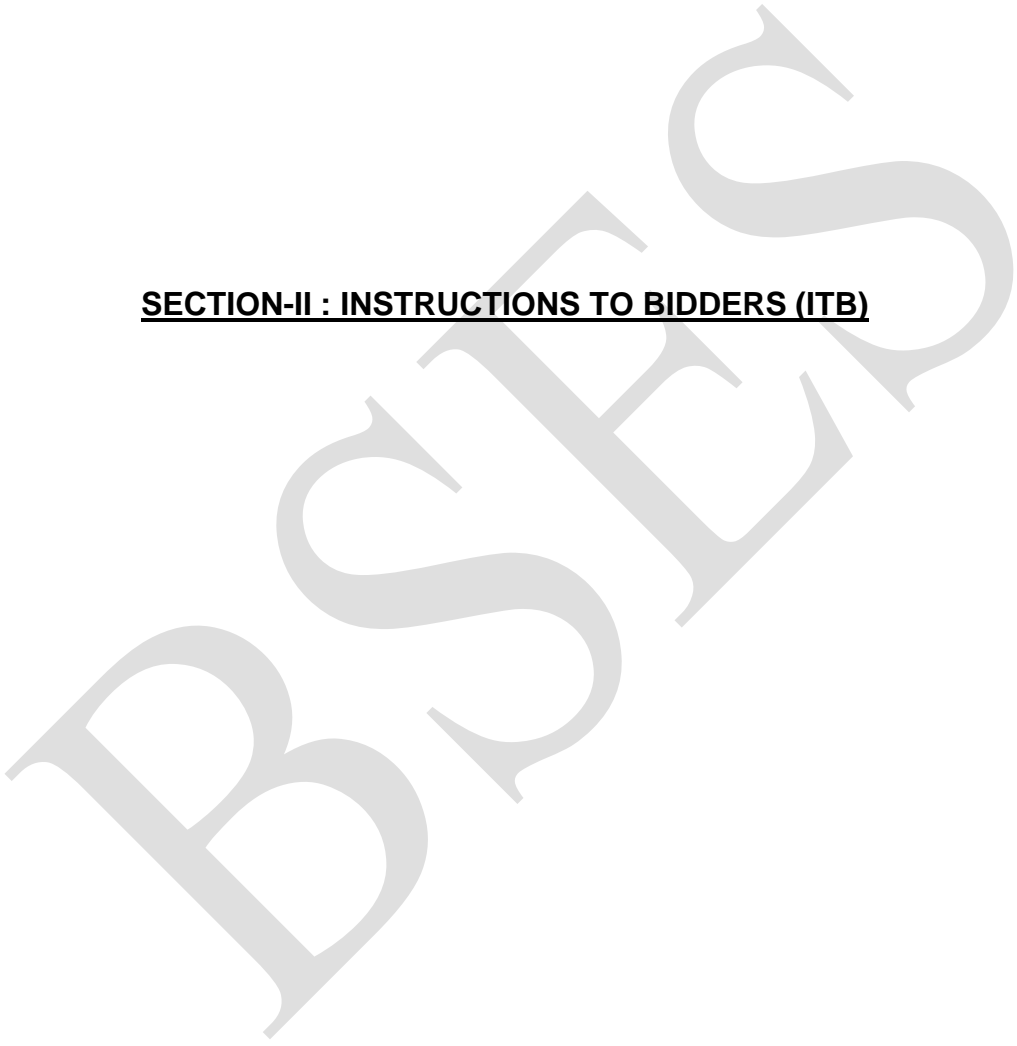

SECTION-II

INSTRUCTIONS TO BIDDERS (ITB)

1. GENERAL

BSES RAJDHANI Power Ltd (BRPL), hereinafter referred to as the "Company" is desirous for awarding work of "Scheme No: EW22GS4011 for LILO of 66kV Tikari Kalan (Mundka) - Nilothi Grid Ckt 1 & 2 at New Proposed Cable Lying for 66kV Bakkarwala Grid.

- 1.1 All the Bids shall be prepared and submitted in accordance with these instructions.
- 1.2 Bidder shall bear all costs associated with the preparation and delivery of its Bid, and the Company will in no case shall be responsible or liable for these costs.
- 1.3 The Bid should be submitted by the Bidder in whose name the bid document has been issued and under no circumstances it shall be transferred /sold to the other party.
- 1.4 The Company reserves the right to request for any additional information/documents and also reserves the right to reject the proposal of any Bidder, if in the opinion of the Company, the data in support of RFQ requirement is incomplete.
- 1.5 The Bidder is expected to examine all instructions, forms, terms & conditions and specifications in the Bid Documents. Failure to furnish all information required in the Bid Documents or submission of a Bid not substantially responsive to the Bid Documents in every respect may result in rejection of the Bid. However, the Company's decision in regard to the responsiveness and rejection of bids shall be final and binding without any obligation, financial or otherwise, on the Company.
- 1.6 The company reserves the right to split the order among various successful bidders in any manner it chooses without assigning any reason whatsoever.

2. SCOPE OF WORK

Detailed specification/scope of work is provided in Section-V of this tender document.

3. DISCLAIMER

- 3.1. This NIT is not an agreement and further it is neither an offer nor an invitation by BRPL to bidders or any other person for award of contract. The purpose of this NIT is to provide bidders information that may be useful to them in the preparation and submission of their bids.
- 3.2. This Document includes statements, which reflect various assumptions, which may or may not be correct. Each Bidder should conduct its own estimation and analysis and should check the accuracy, reliability and completeness of the information in this Document and obtain independent advice from appropriate sources in their own interest.
- 3.3. Neither Company nor its employees will have any liability whatsoever to any Bidder or any other person under the law or contract, the principles of restitution or unjust enrichment or otherwise for any loss, expense or damage whatsoever which may arise from or be incurred or suffered in connection with anything contained in this Document, any matter deemed to form part of this Document, provision of Services and any other information supplied by or on behalf of Company or its employees, or otherwise arising in any way from the selection process for the Work.
- 3.4. Though adequate care has been taken while issuing the Tender document, the Bidder should satisfy itself that Documents are complete in all respects. Intimation of any discrepancy shall be given to this office immediately.

- 3.5. This Document and the information contained herein are Strictly Confidential and are for the use of only the person(s) to whom it is issued. It may not be copied or distributed by the recipient to third parties (other than in confidence to the recipient 's professional advisors).
- 3.6. It shall be deemed that by submitting a bid, a bidder agrees to release BRPL and its employees, agents and advisors irrevocably unconditionally fully and finally from any and all liability for any claims losses damages costs expenses or liabilities in anyway related to or arising from exercise of any rights and all performance of any obligations under this NIT and or in connection with the bid process to the fullest extent permitted by applicable law and waives any and all rights and all claims it may have in this respect whether actual or contingent whether present or in the future
- 3.7. BRPL and its employees and advisors also accept no liability of any nature whether resulting from negligence or otherwise arising from reliance of any bidder upon the contents of this NIT. BRPL may in its absolute discretion but without being under any obligation to do so, update amend or supplement the information assessment statement or assumptions contained in this NIT.
- 3.8. The issue of this tender document does not imply that BRPL is bound to qualify any bidder or to award the contract to any bidder. BRPL reserves the right to reject all or any of the bids without assigning any reasons whatsoever.

4. COST OF BIDDING

The Bidder shall bear all cost associated with the preparation, submission and processing of its Bid and the company will in no case be responsible or liable for the costs.

5. TENDER DOCUMENTS

- 5.1. The Scope of Work, Bidding Procedures and Contract Terms are described in the Bidding Documents. In addition to the covering letter accompanying Bidding Documents, the Bidding Documents include:

"Check List, Sections, Annexure & Formats as elaborated in CONTENT of this NIT."

- 5.2. The bidder is expected to examine the tender documents, including all Instructions, Forms, Terms and Specifications. Failure to furnish all information required by the tender documents or submission of a bid not substantially responsive to the tender documents in every respect may result in the rejection of the Bid.

6. AMENDMENT OF TENDER DOCUMENTS

- 6.1. At any time prior to the deadline for submission of Bids, the Company may for any reason(s), whether at its own initiative or in response to a clarification requested by a prospective Bidder, alter/amend/modify the tender documents by corrigendum /amendment.
- 6.2. The corrigendum / amendment shall be part of tender document, pursuant to Clause 5.1, and it will be notified
 - (a) by way of uploading the corrigendum/amendment on BSES website (in case of public tender),
 - (b) in writing by e-mail to all the Bidders who have received the Bidding Documents by email. (in case of limited tender)

All such corrigendum & amendments will be binding on the bidders.

- 6.3. In order to provide prospective Bidders a reasonable time in which to take the Amendment into account in preparing their Bids, the Company may, at its discretion, extend the deadline for the submission of Bids.

7. PREPARATION OF BIDS & LANGUAGE

The Bid prepared by the Bidder, and all correspondence, documents etc. relating to the Bid exchanged by the Bidder and the Company shall be written in English Language. Any printed literature furnished by the Bidder may be written in another Language, provided that this literature is accompanied by English translation, in which case, for purposes of interpretation of the Bid. In case of ambiguity in the English translation, interpretation of the Company as regards to translation will be final.

8. DOCUMENTS COMPRISING THE BID

The Bid prepared and submitted by the Bidder shall comprise the following components:

- (a) Techno-Commercial Bid & Price Bid as elaborated in RFQ. (STRICTLY AS PER FORMAT)
- (b) All the Bids must be accompanied with the required EMD & Tender Fees against each tender.

9. BID FORM

The Bidder shall complete "Original" Bid Form and submit it along with details mentioned in Techno-Commercial bid (without filling price).

10. BID PRICES

Bidders shall quote for the entire Scope of work with prices for individual items. The bidder is required, at his expense, to obtain all the information he may require to enable him to submit his tender including necessary visits to the site to ascertain the local conditions, procurement of necessary materials, labour, etc., requirements of the local/government/public authorities in such matters.

11. BID CURRENCIES

Prices shall be quoted in Indian Rupees Only.

12. PERIOD OF VALIDITY OF BIDS

- 12.1. Bids shall remain valid & open for acceptance for a period of 180 days from the date of opening of the Bid.
- 12.2. Notwithstanding above, the Company may solicit the Bidder 's consent to an extension of the Period of Bid Validity and the bidder shall be liable to extend the same at the sole cost and consequences of the bidder and no claim from the company in this regard shall be maintainable.

13. ALTERNATIVE BIDS

Bidders shall submit Bids, which comply with the Tender Documents. Alternative Bids will not be considered. The attention of Bidders is drawn to the provisions regarding the rejection of Bids in the terms and conditions, which are not substantially responsive to the requirements of the Tender Documents.

14. FORMAT AND SIGNING OF BID

- 14.1. The original Bid Form and accompanying documents (as specified in Clause 9.0), clearly marked "Original Bid", must be received by the Company at the date, time and place specified in Section-I, RFQ.

- 14.2. The original copy of the Bid shall be typed or written in indelible ink and shall be signed by the Bidder or a person or persons duly authorized to sign on behalf of the Bidder. Such authorization shall be indicated by written Power-of-Attorney accompanying the Bid. All pages of the bid shall be signed by the signatory accompanied with seal of the Agency.
- 14.3. The Bid shall contain no interlineations, erasures or overwriting except as necessary to correct errors made by the Bidder, in which case such corrections shall be signed by the person or persons signing the Bid.

15. SEALING AND MARKING OF BIDS

- 15.1. Bid submission: One original (hard copies) and one duplicate (total two copies) of all the Bid Documents shall be sealed and submitted to the Company before the closing time for submission of the bid.
- 15.2. The Bidder has the option of sending the Bids in person. Bids submitted by Email/Telex/Telegram /Fax will be rejected. No request from any Bidder to the Company to collect the proposals from Courier/Airlines/Cargo Agents etc shall be entertained by the Company.

16. DEADLINE FOR SUBMISSION OF BIDS

- 16.1. The Original bid must be timely received by the company at the address specified in Section –I, RFQ.
- 16.2. The Company may, at its discretion extend the deadline for the submission of bids by amending the Tender Documents in accordance with Clause 6.0, in which case all rights and obligations of the Company and Bidders previously subject to the deadline will thereafter be subject to the deadline as extended.

17. ONE BID PER BIDDER

Each Bidder shall submit only one Bid by itself. A Bidder who submits or participates in more than one Bid will cause all those Bids to be rejected.

18. LATE BIDS

Any Bid received by the Company after the deadline for submission of Bids prescribed by the Company, pursuant to Clause 16.0, will be declared "Late" and rejected and returned unopened to the Bidder.

19. MODIFICATIONS AND WITHDRAWAL OF BIDS

The Bidder is not allowed to modify or withdraw its Bid after the due date of bid submission.

20. EVALUATION OF BID

- 20.1. The bids will be evaluated techno-commercially on compliance to tender terms and Conditions.
- 20.2. BRPL reserves the right to ask the bidders to provide any additional information including breakup of the prices as quoted by them against line items.

21. CLARIFICATION OF BIDS

To assist in the examination, evaluation and comparison of Bids, the Company may, at its discretion, ask the Bidder for a clarification of its Bid. All responses to requests for clarification shall be in writing and no change in the price or substance of the Bid shall be sought, offered or permitted

22. PRELIMINARY EXAMINATION OF BIDS / RESPONSIVENESS

- 22.1. Company will examine the Bids to determine whether they are complete, whether any computational errors have been made, whether required sureties have been furnished, whether the documents have been properly signed, and whether the Bids are generally in order.
- 22.2. Arithmetical errors will be rectified on the following basis. If there is a discrepancy between the unit price and the total price per item that is obtained by multiplying the unit price and quantity, the unit price shall prevail and the total price per item will be corrected. If there is a discrepancy between the Total Amount and the sum of the total price per item, the sum of the total price per item shall prevail and the Total Amount will be corrected.
- 22.3. Company will determine the substantial responsiveness of each Bid to the Tender Documents including execution capability and acceptable quality of the services offered. A substantially responsive Bid is one, which conforms to all the terms and conditions of the Tender Documents without deviation.
- 22.4. Bid determined as not substantially responsive will be rejected by the Company and may not subsequently be made responsive by the Bidder by correction of the non-conformity.

23. EVALUATION AND COMPARISON OF BIDS

- 23.1. The evaluation of Bids shall be done based on the delivered cost competitiveness basis.
- 23.2. The evaluation of the Bids shall be a stage-wise procedure. The following stages are identified for evaluation purposes: In the first stage, the Bids would be subjected to a responsiveness check later on the Techno-Commercial Proposals and the Conditionality of the Bidders would be evaluated.

Subsequently, the Financial Proposals along with Supplementary Financial Proposals, if any, of Bidders with Techno-commercially Acceptable Bids shall be considered for final evaluation.

- 23.3. The Company's evaluation of a Bid will take into account, in addition to the Bid price, the following factors, in the manner and to the extent indicated in this Clause:
- (a) Contract completion schedule
 - (b) Conformance to Qualifying Criteria
 - (c) Deviations from Tender Documents
 - (d) Conformity and compliance to the conditions/details provided in pre-bid meeting
 - (e) Change in the quantity from mentioned in the tender
- 23.4. The cost of all quantifiable deviations and omissions from the specification, terms and conditions specified in Tender Documents shall be evaluated.
- 23.5. The Company will make its own assessment of the cost of any deviation for the purpose of ensuring fair comparison of Bids.
- 23.6. Adjustments in price, if any, based on the above procedures, shall be made for the purposes of comparative evaluation only to arrive at an "Evaluated Bid Price". Bid Prices quoted by Bidders shall remain unaltered.

24. CONTACTING THE COMPANY

- 24.1. From the time of Bid opening to the time of contract award, if any Bidder wishes to contact the Company on any matter related to the Bid, it should do so in writing.
- 24.2. Any effort by a Bidder to influence the Company and/or in the Company's decisions in respect of Bid evaluation, bid comparison or Contract Award, will result in the rejection of the Bidder 's Bid.

25. COMPANY'S RIGHT TO ACCEPT ANY BID AND TO REJECT ANY OR ALL BIDS

The Company reserves the right to accept or reject any Bid and to annul the Bidding process and reject all Bids at any time prior to award of Contract, without thereby incurring any liability to the affected Bidder or Bidders or any obligation to inform the affected Bidder or Bidders of the grounds for the Company's action.

26. AWARD OF CONTRACT

The Company will award the Contract to the successful Bidder whose Bid has been determined to be the lowest-evaluated responsive Bid, provided the Bidder has been determined to be qualified to satisfactorily perform the Contract. Company reserves the right to award order to other bidders in the tender, provided it is required for need of the work. The full or part of the contract may be awarded to other bidder(s) on differential rates.

27. THE COMPANY'S RIGHT TO VARY QUANTITIES

The Company reserves the right to vary the quantity i.e. increase or decrease the Numbers/ quantities without any change in terms and conditions before the award of Contract. Further BRPL may increase or reduce the area/ scale of operations / increase or decrease the Numbers/ quantities after the start of work execution under the contract and the size of contract / contract value shall be adjusted accordingly. In case of decrease in base resources decided mutually then contract value will be adjusted accordingly.

28. LETTER OF INTENT/ NOTIFICATION OF AWARD

The letter of intent/ Notification of Award shall be issued to the successful Bidder whose bids have been considered successful for award of work/order.

The successful Bidder shall be required to furnish acceptance of LOI / notification of award within 7 days of issue of the letter of intent /Notification of Award by Company.

29. CORRUPT OR FRAUDULENT PRACTICES

- 29.1. The Company requires that the Bidders observe the highest standard of ethics during the entire period of work execution under the Contract. In pursuance of this policy, the Company:
 - (a) Defines, for the purposes of this provision, the terms set forth below as follows:

"Corrupt practice" means behaviour on the part of officials in the public or private sectors by which they improperly and unlawfully enrich themselves and/or those close to them, or induce others to do so, by misusing the position in which they are placed, and it includes the offering, giving, receiving, or soliciting of anything of value to influence the action of any such official in the procurement process or in contract execution; and "Fraudulent practice" means a misrepresentation of facts in order to influence a award process or the execution of a contract to the detriment of the Company, and includes collusive practice among Bidders (prior to or after Bid submission) designed to establish Bid prices at artificial non-competitive levels and to deprive the Company of the benefits of free and open competition.

- (b) Will reject a proposal for award if it determines that the Bidder recommended for award has engaged in corrupt or fraudulent practices in competing for the contract in question;
- (c) Will declare a firm ineligible either indefinitely or for a stated period of time, to be awarded a contract if it at any time determines that the firm has engaged in corrupt or fraudulent practices in competing for, or in executing, a contract.

29.2. Furthermore, It shall be the responsibility of the Bidders to read and understand & aware of the provision stated in the Terms and Conditions of tender before participating in the tender.

30. PROCESS TO BE CONFIDENTIAL

Information relating to the examination, clarification, evaluation and comparison of Bids and recommendations for the award of a contract shall not be disclosed to Bidders or any other persons not officially concerned with such process. Any effort by a Bidder to influence the Company's processing of Bids or award decisions may result in the rejection of the Bidder's Bid.

SECTION – III : SPECIAL CONDITIONS OF CONTRACT (SCC)

SECTION – III (A):

SPECIAL CONDITIONS OF CONTRACT (SCC) A:

These Special Conditions of Contract (SCC) shall be read in conjunction with the Terms and Conditions of the Contract, General Conditions of Contract (GCC), Scope of Work and other documents forming part of the contract wherever the context so requires. Notwithstanding the subdivision of documents into separate sections and volumes, every part of each such document shall be deemed to be supplementary to and complementary of every other part.

1. DEFINITIONS

ENGINEER IN-CHARGE (EIC) / OFFICER-IN-CHARGE (OIC)

The term "Engineer-in-charge (EIC)/Officer-in-Charge (OIC)" shall mean the Company's nominated representative for the purpose of supervision of the execution of the Contract. The same shall be mentioned in the Contract.

2. SCOPE OF WORK- SUPPLY

The "Scope of Supply" shall be on the basis of Bidder's responsibility, completely covering the obligations, responsibility and supplies provided in this Bid enquiry whether implicit or explicit.

- Bidder shall have to quote for the Bill of quantities as listed herewith.
- All relevant drawings, data and instruction manuals of supply of miscellaneous material shall be scope of bidder.
- Other petty and miscellaneous material required to execute the work at site shall be in the scope of bidder.
- Qty Variation: The Bidder/purchaser reserves the rights to vary the quantity by (+/-) 30% of the supply of items quantity as listed below.

SR.NO.	Material CODE	DESCRIPTION	UNIT
1	2100217082	Supply of HDPE Pipes, PN 6 class PE 80 - 225mm dia	M
2	2100195673	Supply of RCC Slab (550X675) as per the specification of BRPL/BYPL	EA

3. QUALITY ASSURANCE AND INSPECTION:

- 3.1 Immediately on award of contract, the bidder shall prepare detailed quality assurance plan/test procedure identifying the various stages of manufacture, quality checks performed at each stage, raw material inspection and the Customer hold points. The document shall also furnish details of method of checking, inspection and acceptance standards / values and get the approval of Purchaser before proceeding with manufacturing. However, Purchaser shall have right to review the inspection reports, quality checks and results of suppliers in house inspection department which are not Customer hold points and the supplier shall comply with the remarks made by purchaser or his representative on such reviews with regards to further testing, rectification or rejection, etc. In case of standard items, BRPL shall forward the standard QAP which is to be followed by vendor during manufacturing.
- 3.2 Witness and Hold points are critical steps in manufacturing, inspection and testing where the supplier is obliged to notify the Purchaser in advance so that it may be witnessed by the Purchaser. Final inspection is a mandatory hold point. The supplier can proceed with the work past a hold point only after clearance by purchaser or a witness waiver letter from BRPL.
- 3.03 The performance of waiver of QA activity by Purchaser at any stage of manufacturing does not relieve the supplier of any obligation to perform in accordance with and meet all the requirements

of the procurement documents and also all the codes & reference documents mentioned in the procurement document nor shall it preclude subsequent rejection by the purchaser.

- 3.04 On completion of manufacturing the items can only be dispatched after receipt of dispatch instructions issued by the Purchaser.
- 3.05 All in-house testing and inspection shall be done without any extra cost. The in-house inspection shall be carried out in presence of BRPL/BRPL authorized third party inspection agency. Cost of Futile/abortive visit(s) shall be debited from the invoices.
- 3.06 Purchaser reserves the right to send any material being supplied to any recognized laboratory for testing, wherever necessary and the cost of testing shall be borne by the Bidder. In case the material is found not in order with the technical requirement / specification, the charges along with any other penalty which may be levied is to be borne by the bidder. To avoid any complaint the supplier is advised to send his representative to the stores to see that the material sent for testing is being sealed in the presence of bidder's representative.

4.0 Packing, Packing List & Marking

- 4.01 **Packing:** Supplier shall pack or shall cause to be packed all Commodities in crates/boxes/drums/containers/cartons and otherwise in such a manner as shall be reasonably suitable for shipment by road or rail to BRPL, Delhi/New Delhi stores/site without undue risk of damage in transit.
- 4.02 **Packing List:** The contents of each package shall be itemized on a detailed list showing the exact weight, extreme outside dimensions (length, width & weight) of each container/box/drum/carton, Item SAP Code, PO No & date. One copy of the packing list shall be enclosed in each package delivered.

5.0 Price basis for supply of materials

Bidder has to quote their prices on Landed Cost Basis and quote separate price for each item.

FIRM prices for supply to BRPL Delhi/New Delhi stores inclusive of packing, forwarding, loading at manufacturer's premises, payment of all taxes, GST, Freight, any other local charges etc.

The above supply prices shall also include unloading at BRPL Delhi/New Delhi stores/site. Transit insurance will be arranged by bidder.

6.0 Terms of payment and billing – SUPPLY

- a) 80 % against R/A bills for supply of equipment and materials within 30 days against receipt of material at site and submission of following documents duly certified by BRPL Project-in-charge:
- i. Consignee copy of LR
 - ii. Detailed invoice showing commodity description, qty, unit & total price,
 - iii. Original certificate issued by BRPL confirming receipt of material at site & acceptance
 - iv. Dispatch clearance & inspection report issued by the inspection authority
 - v. Packing List, Test Reports
 - vi. Guarantee Certificate.
- b) 10% pro-rata after installation/erection of equipment duly certified by BRPL Project-in-charge.
- c) 10% pro-rata after completion of successful acceptance testing, commissioning and handing over of the entire Installation and duly certified by BRPL Project-in-charge.

7.0 Price Validity

- 7.01 All bids submitted shall remain valid, firm and subject to unconditional acceptance by BRPL Delhi for 120 days from the due date of submission & subsequent corrigendum/amendment/extension of due date of submission. For awarded

suppliers/contractors, the prices shall remain valid and firm till contract completion.

8.0 Contract Performance Bank Guarantee:

8.1 CONTRACTOR shall furnish the Contract Performance Bank Guarantee in the prescribed format (Appendix I) within 15 days from the date of issue of Order for due performance of the provisions of purchase Order.

The contract Performance Bank Guarantee shall be given below table -1 and shall be valid till the completion of defect liability period plus three (3) months or latest RBI guidelines (if any) whichever is higher towards claim period, if not otherwise specified in agreement. This amount shall remain fixed during the currency of the agreement.

Sr. No.	Scheme Details	CPBG Amount of Supply in Rs.
1	Scheme No: EW22GS4011	5,76,223 /-

8.1 The CPBG shall be issued from any nationalized / scheduled bank as per company format.

8.2 The Company shall reserve the right to invoke the CPBG unconditionally and without recourse to the Contractor, if there is failure to perform any part of the Agreement for whatsoever reason. This clause is pertaining to performance of contractual obligations and the decision of Company shall be final in this regard.

8.3 In the event of any claim or any other outstanding Contractual obligations remaining unfulfilled, the Contractor shall be required to extend the CPBG till the settlement of all claims and completion of all Contractual obligations at the cost and consequences of contractor.

8.4 In the event, in Company's sole judgement, the Contractor has fulfilled all its obligations under this Agreement, The CPBG shall be released without any interest after the expiry of CPBG and its claim period as mentioned above.

8.5 If the CPBG is or becomes invalid for any reason (other than its expiry), the Contractor shall immediately notify the Company/BRPL and provide within five (5) days a replacement CPBG in the form set out in the Contract/Agreement.

8.6 Not later than sixty (60) Business Days before the expiry of the CPBG, the Contractor shall, upon request of the Company/BRPL obtain extension of the validity of such CPBG for the period stated in such request by the Company/BRPL and provide a copy of such renewed CPBG.

It is Contractor's responsibility to incur charges / cost to maintain and for extension of CPBG without claiming reimbursement from the company/BRPL.

9.0 Forfeiture

9.01 Each Performance Bond established under Clause 10.0 shall contain a statement that it shall be automatically and unconditionally forfeited without recourse and payable against the presentation by BRPL of this Performance Bond, to the relevant bank referred to above, together with a simple statement that supplier has failed to comply with any term or condition set forth in the Contract.

9.02 Each Performance BG established under will be automatically and unconditionally forfeited without recourse if BRPL at its sole discretion determines that supplier has failed to comply with any term or condition set forth in the contract.

10.0 Release

All Performance Bonds will be released without interest within seven (7) days from the last date up to which the Performance Bond has to be kept valid (as defined in Clause 10.0) except for the case set forth in Clause 21.0.

11.0 Guarantee of Performance

The bidder shall stand guarantee that the equipment and material supplied/service or work rendered under the contract is free from design, manufacturing, material, construction, erection & installation and workmanship & quality defects and is capable of its due, rated and intended quality performance, as an integrated product delivered under the contract for a specific period termed as Guarantee Period. The bidder should also guarantee that the equipment/material is new and unused except for the usage required for the tests and checks required as part of quality assurance.

12.0 Guarantee Period/Defects Liability Period

The Guarantee Period will be equipment/service/work specific and shall be as specified in the Technical Specifications for the equipment/material/service/work and where Technical specifications are not part of contract documents or guarantee period is not specified in the Technical specifications, the guarantee period shall be as per the Special Terms and Conditions of the Contract. In case of no mention of the guarantee period in Technical specifications, Defect liability period will be 12 Months from the Date of Commissioning or 18 months from the date of delivery of final lot of supplies made, whichever is later.

If during the defects liability period any materials / items are found to be defective, these shall be replaced or rectified by the bidder at his own cost within 30 days from the date of receipt of intimation.

13.0 Cost of repairs on failure in Guarantee Period:

The cost of repairs/rectification /replacement, apart from the actual cost of repairs/rectification/replacement is also inclusive of all bidder costs of required transportation, site inspection /mobilization/dismantling and re-installation costs as applicable, to be borne by the bidder. The bidder has to ensure that the interruption in the usage of intended purpose of the equipment is minimized to the maximum extent In lieu of the time taken for repairs/rectification/replacement.

14.0 Latent Defect:

Hidden defects in manufacturing or design of the product supplied and which could not be identified by the tests conducted but later manifested during operation of the equipment are termed as latent defects. Bidder shall further be responsible for 'free replacement' for another period of FIVE years from the end of the guarantee period for any 'Latent Defects' if noticed and reported by the Purchaser.

15.0 Support beyond the Guarantee Period

15.1 The Bidder shall ensure availability of spares and necessary support for a period of at least 10 years post completion of guarantee period of equipment /technology supplied against this contract. BRPL shall be duly intimated by the Vendor of End of Life Support for the product /technology supplied at least 12 months in advance.

16.0 Return, Replacement or Substitution

BRPL shall give Supplier notice of any defective Commodity promptly after becoming aware thereof. BRPL may at its discretion elect to return defective Commodities to Supplier for replacement, free of charge to BRPL, or may reject such Commodities and purchase the same or similar Commodities from any third party. In the latter case BRPL shall furnish proof to Supplier of the cost of such substitute purchase. In either case, all costs of any replacement, substitution, shipping, labour and other related expenses incurred in connection with the return and replacement or for the substitute purchase of a Commodity hereunder should be for the account of Supplier. BRPL may set off such costs against any amounts payable by BRPL to

Supplier. Supplier shall reimburse BRPL for the amount, if any, by which the price of a substitute Commodity exceeds the price for such Commodity as quoted in the Bid.

17.0 Effective Date of Commencement of Contract:

The date of the issuance of the Letter of Acceptance/Purchase Order shall be treated as the effective date of the commencement of Contract.

18.0 Time – The Essence of Contract:

Time is the essence of the contract and the contractor shall be responsible for performance of his works in accordance with the specified schedule. If at any time, the contractor is falling behind the schedule for reasons attributable to him, he shall take necessary action to make good for such delays by increasing his work force or by working overtime or otherwise to accelerate the progress of the work and to comply with schedule timelines and shall communicate such actions in writing to the company, to the satisfaction of the Company that his action will compensate for the delays. The contractor shall not be allowed any extra compensation for such actions.

Time shall be the essence of the Contractor. Contractor shall complete his work in accordance with the specified time-lines/ Schedules as per the terms of the contract or as may be instructed by the Company from time to time..

19.0 The Laws and Jurisdiction of Contract:

The laws applicable to this Contract shall be the Laws in force in India. To the best of their ability, the parties hereto shall endeavor to resolve amicably between themselves all disputes arising in connection with this work order. If the same remain unresolved within thirty (30) days of the matter being raised by either party, either party may refer the dispute for adjudication by arbitration. The arbitration shall be undertaken by the sole arbitrator jointly appointed by the parties. In case the parties fail to arrive at consensus to appoint the sole arbitrator, either party may approach the Court for appointing an arbitrator under Section 11 of the Arbitration and Conciliation Act, 1996 and the award of the said sole arbitrator, shall be final and binding upon the parties. The arbitration proceeding shall be conducted in accordance with this provisions of the Indian Arbitration & Conciliation Act, 1996 (as amended up to date) and the venue of such arbitration shall be the city of New Delhi only. The Arbitration shall be conducted in English language only. The courts at Delhi shall have the exclusive jurisdiction over the subject matter of Arbitration/dispute. The cost of the Arbitration shall be equally shared by the parties as per directions of the Sole Arbitrator.

20.0 Events of Default

21.01 Company may, without prejudice to any of its other rights or remedies under the Contract or in law, terminate the whole or any part of this Contract by giving written notice to the Contractor, if in the opinion of Company, contractor has neglected to proceed with the Contracts with due diligence or commits a breach of any of the provisions of this Contract including but not limited to any of the following cases:

- A) Failing to complete execution of Contract as per the terms and conditions specified in the Contract.
- B) Failing to complete Contracts in accordance with the approved schedule of Contract.
- C) Failing to comply with any reasonable instructions or orders issued by Company in connection with the Contract.
- D) Failing to comply with any of the terms or conditions of this Contract.
- E) In the event Company terminates this Contract, in whole or in part, on the occurrence of any event of default, Company reserves the right to engage any other vendor or agency to complete the Contract or any part thereof, and in addition to any other right Company may have under the Contract or in law including without limitation, including the right to penalize for delay under clause

“Liquidated Damage” of this Contract, the contractor shall be liable to Company for any additional costs that may be suffered/borne by Company for the execution of the Contract.

- F) Failure on the part of the Contractor to maintain its confidentiality obligations and or compromising its integrity, which are required to be of highest standards, in so far as the present scope of work is concerned.

21.0 Consequences of Default

(a) If an Event of Default shall occur and be continuing, BRPL may forthwith terminate the Contract by written notice.

(b) In the event of an Event of Default, BRPL may, without prejudice to any other right granted to it by law, or the Contract, take any or all of the following actions;

(i) present to Bank for forfeiture to the relevant bank the Performance Bond;

(ii) Purchase the same or similar Commodities from any third party; and/or

(iii) Recover any losses and/or additional expenses BRPL may incur as a result of Supplier's default.

22.0 Liquidated Damages

22.01 In the event of any delay in completion of the work beyond the stipulated time given by in order due to reasons solely attributable to the Contractor, the Contractor shall pay to the Company liquidated damages.

If the Contractor failed perform the services within the time period specified in the order, the Company shall, without prejudice to its other remedies under the contract, deduct liquidated damages a sum equivalent to 2.0% of the billed amount of final work executed for each week or part there of delay until the actual date of completion up to a maximum deduction of 20% of billed amount of final work executed. Once the maximum is reached to Company may consider termination of contract without any liabilities to Company.

In case the contractor has not mobilized / taking up the job as per the direction of Engineer In-charge, the company have all rights to cancel / re-allocate the work allotted to the contractor.

Engineer In charge should specifically mention the amount of LD levied on the bill of contractor for this job.

23.0 Statutory variation in Taxes and Duties

The total order value shall remain **FIRM** within stipulated delivery period and shall not be adjusted on account of any price increase/variations in commodities & raw materials. However Statutory Taxes, duties and Levies imposed by Competent Authorities by way of fresh notification(s) within the stipulated delivery period shall be borne by BRPL on submission of necessary documents claiming such variation. The variation will be applicable only on such value wherever price breakup of same is submitted by vendor/available in PO/WO.

24.0 Force Majeure

24.01 General

An "Event of Force Majeure" shall mean any event or circumstance not within the reasonable control directly or indirectly, of the Party affected, but only if and to the extent that:

- (i) Such event or circumstance materially and adversely affects the ability of the affected Party to perform its obligations under this Contract, and the affected Party has taken all reasonable precautions, due care and reasonable alternative measures in order to prevent or avoid the effect of such event on the affected party's ability to perform its obligations under this Contract and to mitigate the consequences thereof.
- (ii) For the avoidance of doubt, if such event or circumstance would not have materially and adversely affected the performance of the affected party had such affected party

followed good industry practice, such event or circumstance shall not constitute force majeure.

- (iii) Such event is not the direct or indirect result of the failure of such Party to perform any of its obligations under this Contract.
- (iv) Such Party has given the other Party prompt notice describing such events, the effect thereof and the actions being taken in order to comply with above clause.

24.02 Specific Events of Force Majeure subject to the provisions of above clause, Events of Force Majeure shall include only the following to the extent that they or their consequences satisfy the above requirements:

- (i) The following events and circumstances:
 - a) Effect of any natural element or other acts of God, including but not limited to storm, flood, earthquake, lightning, cyclone, landslides or other natural disasters.
 - b) Explosions or fires.
- (ii) War declared by the Government of India, provided that the ports at Mumbai are declared as a war zone.
- (iii) Dangers of navigation, perils of the sea.

24.03 Notice of Events of Force Majeure If a force majeure event prevents a party from performing any obligations under the Contract in part or in full that party shall:

- i) Immediately notify the other party in writing of the force majeure events within 7(seven) working days of the occurrence of the force majeure event
- ii) Be entitled to suspend performance of the obligation under the Contract which is affected by force majeure event for the duration of the force majeure event.
- iii) Use all reasonable efforts to resume full performance of the obligation as soon as practicable
- iv) Keep the other party informed of all such efforts to resume full performance of the obligation on a regular basis.
- v) Provide prompt notice of the resumption of full performance or obligation to the other party.

24.04 Mitigation of Events of Force Majeure Each Party shall:

- (i) Make all reasonable efforts to prevent and reduce to a minimum and mitigate the effect of any delay occasioned by an Event of Force Majeure including recourse to alternate methods of satisfying its obligations under the Contract;
- (ii) Use its best efforts to ensure resumption of normal performance after the termination of any Event of Force Majeure and shall perform its obligations to the maximum extent practicable as agreed between the Parties; and
- (iii) Keep the other Party informed at regular intervals of the circumstances concerning the event of Force Majeure, with best estimates as to its likely continuation and what measures or contingency planning it is taking to mitigate and or terminate the Event of Force Majeure.

24.05 Burden of Proof In the event that the Parties are unable in good faith to agree that a Force Majeure event has occurred to an affected party, the parties shall resolve their dispute in accordance with the provisions of this Agreement. The burden of proof as to whether or not a force Majeure event has occurred shall be upon the party claiming that the force majeure event has occurred and that it is the affected party.

24.06 Termination for Certain Events of Force Majeure. If any obligation of any Party under the Agreement is or is reasonably expected to be delayed or prevented by a Force Majeure event for a continuous period of more than 1 (one) month during the Term of the Agreement, the Agreement shall be terminated at the discretion of the Company and neither Party shall be liable to the other for any consequences arising on account of such termination.

The Company reserves the right to demand the Contractor's services on holidays as well as beyond the normal working hours.

The Contractor will ensure that none of their person is engaged in any unlawful activities subversive of the Company's interest failing which suitable action may be taken against the Contractor as per the terms and condition of this order.

The Contractor shall be liable for payment of all taxes and duties as applicable, to the State/ Central Govt. or any local authority.

The Contractor's employees shall not be treated as Company's employees / persons for any purpose whatsoever & facilities/ benefits applicable to the Company's employees shall not be applicable to Contractor's employees. If due to any reasons whatsoever the Company is made liable to meet any obligation under any of the laws & enactment etc, for any reason whatsoever the same shall be recovered from the Contractor either from the present and future amount payable to him or as per law.

25.0 Transfer and Sub-Letting

The Contractor shall not, without company's prior consent in writing assign or sublet or transfer any portion of services awarded to the Contractor as envisaged herein and falling under this contract. Moreover, any such consent shall not relieve the Contractor from any obligation, responsibility, or duty under this Contract.

26.0 Recoveries

When ever under this contract any money is recoverable from and payable by the bidder, the purchaser shall be entitled to recover such sum by appropriating in part or in whole by detecting any sum due to which any time thereafter may become due from the supplier in this or any other contract. Should the sum be not sufficient to cover the full amount recoverable the bidder shall pay to the purchaser on demand the remaining balance.

27.0 Waiver

No delay or forbearance by company in exercising any right or power under this Agreement shall be construed as a waiver of such right or power, nor shall any single or partial exercise of such right or power preclude any further exercise of such right of power.

28.0 Indemnification

Notwithstanding contrary to anything contained in this RFQ, Supplier shall at his costs and risks make good any loss or damage to the property of the Purchaser and/or the other Supplier engaged by the Purchaser and/or the employees of the Purchaser and/or employees of the other Supplier engaged by the Purchaser whatsoever arising out of the negligence of the Supplier while performing the obligations under this contract.

29.0 Documentation

The Bidder's shall procure all equipment from BRPL approved sources as per attached specifications. The Bidder's shall submit 5 copies of Material/Type Test Certificates, O&M Manuals, and Approved & As-built drawings. The Bidder's shall ensure for the strict compliance to the specifications and Field Quality Procedures issued by BRPL Engineer in-charge.

30.0 Commissioning Spares

Commissioning Spares shall be deemed to be included in the quoted prices

31.0 Limitation on Liability

31.1 The Contractor's liability (except Third Party Liability; covered under the agreement and addendums thereto) for all damages, losses, acts or omissions, howsoever occasioned, shall not, at any time exceed an amount equivalent to Contract Value.

31.2 Notwithstanding anything stated in the agreement, the limitation of Liability shall not be available/applicable in case of wilful default/breach/negligent act/misconduct on the part of the Contractor and/or its employees.

32.0 Consequential Damages

Notwithstanding anything to the contrary in the Purchase Order, except for breach of obligations under Non-disclosure and except as expressly provided in a Purchase Order, in no event, as a result of breach of contract or breach of warranty or otherwise, shall either Party hereto or either Party's Affiliates or sub Contractors, be liable under the Purchase Order to the other Party for any consequential, special, indirect, exemplary or incidental damages, and/or for any lost profits, goodwill or revenues of such Party, howsoever arising, before or after Acceptance of the Goods and whether or not such damages are foreseeable.

BSES

SECTION – III (B):

SPECIAL CONDITIONS OF CONTRACT (SCC) B:

These Special Conditions of Contract (SCC) shall be read in conjunction with the Terms and Conditions of the Contract, General Conditions of Contract (GCC), Scope of Work and other documents forming part of the contract wherever the context so requires. Notwithstanding the subdivision of documents into separate sections and volumes, every part of each such document shall be deemed to be supplementary to and complementary of every other part.

1. DEFINITIONS

ENGINEER IN-CHARGE (EIC) / OFFICER-IN-CHARGE (OIC)

The term "Engineer-in-charge (EIC)/Officer-in-Charge (OIC)" shall mean the Company's nominated representative for the purpose of supervision of the execution of the Contract. The same shall be mentioned in the Contract.

2. SCOPE OF WORK- SERVICES

The scope includes material transportation, GPR Survey of Route, digging of trench, cable laying, Supply and Laying HDPE Pipes, cable cover, Backfilling levelling of trench, Covering of Malba, Dust mitigation Measures at Site, Close Barricading, Removal of Surplus Malba, Fabrication and Erection of Steel Structure, Supply & Installation of LIU, OFC Laying, Termination etc as per detailed scope of work as enumerated in Section – V. Vendor is responsible for taking the Permission (Liasoning work) from Road owning agencies & Delhi Police, statutory fees will be borne by BRPL. Electrical Inspector Clearance fees shall be in Bidder's scope. The related fees, payments and pursuance work shall be in scope of Bidder only.

3. EFFECTIVE DATE, TIME AND VALIDITY

- 3.1 The order/agreement shall become effective for all purposes from the date to be specified under the agreement and continue to remain in force for the period till 15th May 2025.
- 3.2 You are required to mobilize your manpower within 7 days of receipt of PO & WO and commence the activity as per instructions of Engineer In-charge. The entire work should be completed till 15th May 2025 from the date of issue of order.
- 3.3 The detailed schedule and milestone completion dates would be as per the contract schedules given from time to time by Engineer In-charge at site. You shall submit a weekly progress report to Engineer In charge.

4. ORDER VALUE

Value of the Contract will be contracted out on the basis of finalized rates.

The Contractor shall not be entitled to adjustment in the Service Fees during the term of this Agreement for increase due to

- (a) increased labour costs or costs related to vehicles or other Equipment's provided,
- (b) changes in insurance premiums, and/or
- (c) Changes in legislations or regulations relating to the Service.
- (d) The cost of insurance during loading/unloading of materials/ equipments during its storage and handling/erection at site for installation is included in the contractor's scope and value will be included in the work order value. The unit rates are also inclusive of barricading charges and watch & ward charges during execution and no separate charges shall be paid for the same.

5. RATES & ESCALATION

- a. The Rates/Agreement Consideration are firm and fixed for the Agreement period. The Rates shall not be subject to escalation or increases on any account/reason(s) whatsoever.
- 5.2 The rates set out above are also inclusive of reasonable incidental expenses incurred by Contractor on the following:
- I. Cost of Labour, tackles and supervision.
 - II. All taxes and levies, including but not limited to GST, etc as applicable during the currency of the contract.
 - III. Mobile and Conveyance of the Contractor's employees up to place of work and/ or from one place to another place for carrying out the job.
 - IV. Uniform with all accessories for the team as per the sample decided.
 - V. Rates shall be valid for all heights and locations.
 - VI. All other expenses incidental to the job.
 - VII. The Company shall pay only once against the service provided irrespective of the fact that the Contractor might have to take more than one attempts for providing the service.
 - VIII. Compliance with all labour laws including Minimum Wage Act, Bonus Act, The Sexual Harassment of Women at Workplace (Prevention, Prohibition and Redressal) ACT, 2013 etc in respect of employees engaged by the Contractor for the discharge of services as per this agreement.

6. CONTRACT CUM PERFORMANCE SECURITY BANK GUARANTEE (CPBG)

- a. Contractor shall furnish the CPBG in the prescribed format within 15 days from the date of issue of LOI / Work Order for due performance of the provisions of Work Order/Agreement.
- b. The contract Performance Bank Guarantee shall be given below table -1 and shall be valid till the completion of defect liability period plus three (3) months or latest RBI guidelines (if any) whichever is higher towards claim period, if not otherwise specified in agreement. This amount shall remain fixed during the currency of the agreement.

Table -1 (CPBG required for given below Scheme for Services)		
Sr. No.	Scheme Details	CPBG Amount of Services in Rs.
1	Scheme No: EW22GS4011	12,39,190 /-

- c. The CPBG shall be issued from any nationalized / scheduled bank as per company format.
- d. The Company shall reserve the right to invoke the CPBG unconditionally and without recourse to the Contractor, if there is failure to perform any part of the Agreement for whatsoever reason. This clause is pertaining to performance of contractual obligations and the decision of Company shall be final in this regard.
- e. In the event of any claim or any other outstanding Contractual obligations remaining unfulfilled, the Contractor shall be required to extend the CPBG till the settlement of all claims and completion of all Contractual obligations at the cost and consequences of contractor.
- f. In the event, in Company's sole judgement, the Contractor has fulfilled all its obligations under this Agreement, The CPBG shall be released without any interest after the expiry of CPBG and its claim period as mentioned above.
- g. If the CPBG is or becomes invalid for any reason (other than its expiry), the Contractor shall immediately notify the Company/BRPL and provide within five (5) days a replacement CPBG in the form set out in the Contract/Agreement.
- h. Not later than sixty (60) Business Days before the expiry of the CPBG, the Contractor shall, upon request of the Company/BRPL obtain extension of the validity of such CPBG for the period stated in such request by the Company/BRPL and provide a copy of such renewed CPBG.

- i. It is Contractor's responsibility to incur charges / cost to maintain and for extension of CPBG without claiming reimbursement from the company/BRPL.

7. PAYMENT TERMS

Payment shall be made to you as under:

- 7.1 80% payment shall be released on submission of bill and certification of work completion by Engineer-In-charge. The bill shall be paid within 30 days on receipt of such bills at our office.
- 7.2 10% against submission of Electrical Inspectorate's & QC clearance certificate.
- 7.3 Balance 10% shall be paid on testing and commissioning of entire scheme, work completion certificate issued by our Engineer In charge.
- 7.4 The contractor shall submit the invoice along with the checklist duly filled in Invoice shall be processed and payment shall be made to contractor on certification of Engineer-In Charge for compliance to check point's given in check list.
- 7.5.1 All monitoring, measurement, billing & payment processes shall be on IT enabled platform of BRPL as per Company's guidelines issued from time to time and bidders to ensure adherence.
- 7.6 Contractor shall upload bills along with all supporting documents in online BTS (Bill Tracking Systems) software or any other IT enabled platform of BRPL as per Company's guidelines issued from time to time for certification / approval purpose and bidders to ensure adherence. Further the contractor shall also submit original bill (hard copy) along with all supporting documents at Vendor Support Cell of BRPL. The bills shall be made in favor of BSES Rajdhani Power Ltd, BSES Bhawan, Nehru Place, New Delhi - 110019.
- 7.7 Company shall make payments, without any interest/charges and after deduction of taxes, penalties as applicable, against the bills within 30 days from the date of receipt of the bills, duly verified and certified by Engineer-in-Charge.
- 7.8 <<Deleted>>
- 7.9 The bill shall consist of the prescribed documents on standard stationary designed by the Company. Contractor shall collect the details of such documents and formats from the Company.
- 7.10 Contractor shall, at no point of time, claim or have the right to claim any additional fees, expenses or charges of any nature whatsoever, other than the Rates set out in the contract.
- 7.11 The company may modify the procedure for the submission of bills. The Contractor shall be obliged to submit its bill as per the procedure stipulated by the company from time to time.

8. PENALTY

8.1 Penalty: A penalty of 2.5% of bill amount shall be levied in each case of non-compliance of safety practices and site cleanliness.

8.2 Liquidated Damages: In the event of any delay in completion of the work beyond the stipulated time given by in order due to reasons solely attributable to the Contractor, the Contractor shall pay to the Company liquidated damages.

If the Contractor failed perform the services within the time period specified in the order, the Company shall, without prejudice to its other remedies under the contract, deduct liquidated damages a sum equivalent to 2.0% of the billed amount of final work executed for each week or part there of delay until the actual date of completion up to a maximum deduction of 20% of billed amount of final work executed. Once the maximum is reached to Company may consider termination of contract without any liabilities to Company.

In case the contractor has not mobilized / taking up the job as per the direction of Engineer In-charge, the company have all rights to cancel / re-allocate the work allotted to the contractor.

Engineer In charge should specifically mention the amount of LD levied on the bill of contractor for this job.

8.4 Penalty related to HR issues & ID Cards shall be applicable as defined in GCC.

8.5 Penalty for noncompliance of statutory regulations shall be applicable as defined in GCC.

8.6 Penalty for misconduct/failure in performance of task under the agreement shall be applicable as defined in GCC.

8.7 Penalty for violation of safety & quality norms shall be applicable as defined in Annexure IV, EHS Conditions of the Contract.

9. DERC GUIDELINES & REGULATIONS

The bidder shall make himself fully aware & familiarise with prevailing DERC guidelines / regulations.

10. INSURANCE POLICIES

The contractor shall take suitable insurance policy for its men and materials (Term Insurance for life , GPA, Medclaim policy, Workmen Compensation Policy etc.) as listed below for the resources deployed by him

a) Term Insurance for life:

Before commencing the execution of the work, the CONTRACTOR shall take TERM INSURANCE POLICY for the staff engaged by them for this work to insure against any loss of life . The policy shall have coverage of Rs.10 Lakhs. The Contractor shall be responsible for on-the-spot same day claim settlement with the victim's legal heirs without waiting for settlement by insurance claim without any liability on BRPL.

b) Group Personal Accident Insurance:

Before commencing the execution of the work the Contractor shall take Accidental insurance policy for the staff engaged/deployed by him for the work under agreement, to insure against any loss of life which may occur during the agreement for the work of the Company. The policy shall have coverage of Rs. 5 Lakh (Table C Death + Permanent Total Disability + Partial permanent Disability due to external accidents). Permanent total disability coverage shall be 125% of the basic sum assured of Rs 5 Lakh.

The Contractor shall be responsible for on the spot same day claim settlement with the victim's legal heirs without waiting for settlement by insurance claim and without any liability on BRPL. The premium amount for both the above policies shall be borne by the Contractor. The Contractor shall furnish copy of policy within 15 days of start of work under the contract.

c) Medical Insurance Policy:

Contractor shall take a medclaim policy including family floater of minimum sum assured value Rs. 2.00 lakhs for the resources who are not covered under ESI.

d) Comprehensive Marine Storage cum Erection insurance policy:

Company shall take at his own cost Comprehensive Marine Storage cum Erection insurance policy for the total work. However, Contractor shall take at his own cost third party insurance and other suitable insurance policy for his own men and materials. Please note that these insurance policies shall be taken in consultation with the company and a copy of the such insurance policies shall have to be furnished to company within 15 days of the date of LOI/Order.

e) For all the insurance policies (whether taken by the Company or Contractor), the Contractor shall be responsible for settlement of claims with the underwriters without any liability on the

company and will arrange replacements / rectification expeditiously without a waiting settlement of insurance claim, at contractor's own cost and this shall not entitle the Contractor for any extension of time.

11. WARRANTY / DEFECT LIABILITY PERIOD

The Contractor shall be liable to rectify all defects in the materials or works done by the Contractor under this Contract, or from any act or omission of the contractors for a period of Twelve (12) months from date of final work completion certification by the Engineer in-charge.

If any defect noticed and system cannot be used by reason of any defect, the defect liability period shall be extended by the period equal to the period during which the system is not in operation.

In respect of any warranty work performed by the Contractor, the period during which a claim may be made for such warranty work shall be extended by an additional period of twelve (12) months from the completion of such portion of warranty work.

12. QUALITY:

Contractor shall ensure that strict quality is maintained in the Performa and execution of works under this Work Order and Works are executed in conformity with the Specification.

All tools, tackles, instruments and other equipments used in the execution of the Works shall be duly calibrated as required and Contractor shall maintain proper records of such tools, tackles, instruments and / or equipment.

Contractor shall prepare the quality plan as per the specifications and shall strictly monitor compliance with the approved quality plan during the entire period of this Work Order.

Contractor shall submit duly approved Quality Check sheets along with final bill and the same shall be integral part of final Quality Clearance. QA Check sheets format attached with this contract as Annexure-A for the following:

QA - CHECKSHEET FOR 11KV RMU

QA - CHECKSHEET FOR 11KV TERMINATION

QA - CHECKSHEET FOR DISTRIBUTION TRANSFORMER

QA - CHECKSHEET FOR FEEDER PILLAR

QA - CHECKSHEET FOR FENCING

QA - CHECKSHEET FOR HIGH MAST

QA - CHECKSHEET FOR HT OVERHEAD LINE 11KV

QA - CHECKSHEET FOR LT ACB

QA - CHECKSHEET FOR OH LT LINE

QA - CHECKSHEET FOR PKG SUB-STN

QA - CHECKSHEET FOR ROUTINE ELECTRICAL TESTS

QA - CHECKSHEET FOR STREET LIGHT

QA - CHECKSHEET FOR UNDERGROUND HT CABLE 11KV

QA - CHECKSHEET FOR UNDERGROUND LT CABLE

QA - CHECKSHEET FOR POWER TRANSFORMER (EHV)

13. WORK COMPLETION CERTIFICATION, HANDING OVER AND MATERIAL RECONCILIATION:

The work carried out by the Contractor under this order has to be certified by Engineer In-charge for satisfactory completion of work allotted to the contractor with respect to specifications / Field Quality Procedures as per applicable standards. In case of modification/correction to be carried out, contractor shall carry out the said modifications/correction without additional cost. The Contractor shall remain in close contact with Engineer In-Charge at site to report the general findings of the fieldwork during the initial as well as later stage of the work at site. The contractor shall be solely responsible for any shortage or damage of materials issued to them handling of and / or in storage and erection at site and cost of the same will be recovered from the contractor as certified by Engineer In-Charge. Contractor must submit a material reconciliation statement in the approval format with Bill raise by him. The contractor shall maintain an accurate and exhaustive record detailing out the list of all items received by him for the purpose of erection and keep such record open for the inspection of the company.

14. COMPLETION PERIOD:

You are required to mobilize your manpower within 7 days of receipt of WO and commence the activity as per instructions of Engineer In-charge. The entire work should be completed till 15th May 2025 from the date of issue of order.

The detailed schedule and milestone completion dates would be as per the contract schedules given from time to time by Engineer In-charge at site. Formal road cutting clearance from MCD is made available to you. You shall submit a weekly progress report to Engineer In charge.

15. GUIDELINES REGARDING INSPECTION & MAINTENANCE OF PITS /DUG AREA WHILE DOING WORK AT SITE IN BRPL AREA

The contractor shall ensure strict compliance of the following directions:

- a) The sites of all manholes, pits, holes, tanks or any other opening in the ground of any kinds shall be regularly inspected and maintained.
- b) Schedule and protocols of inspections and maintenance shall be drawn up and notified to BRPL.
- c) These sites shall be cordoned off (Close Barricades) to render them inaccessible to the public.
- d) The existence of these sites shall be clearly & visibly marked by the display of signboards/signages.
- e) If they are required to be covered, it shall be ensured that the covers are in place.
- f) If required, as per law, prior permission from authorities shall be secured before the commencement of work. The Execution contractor shall solely be responsible for all the preventive and protective environmental steps as per guidelines. Any violations from the above guidelines have been viewed very seriously by the authorities. Contractor is liable for the penalties / other action by the authorities, the contractor shall indemnify BRPL its employees/directors/associates from all liabilities/penalties/claims including litigation expenses on this account.

SECTION – IV : GENERAL CONDITIONS OF CONTRACT (GCC)

SECTION – IV

GENERAL CONDITIONS OF CONTRACT (GCC)

This GCC shall form an integral part of the Agreement and will be of full force and effect as if they were expressly set out in the body of the Agreement.

Reference to any legislation or law to any provision thereof shall include references to any such law as it may, after the date hereof, from time to time, amended, supplemented or re-enacted, and any reference to a statutory provision, shall include any subordinate legislation made from time to time under that provision.

1. DEFINITION & INTERPRETATION

1.1 Definition

In the Agreement (as defined below) the words and expressions defined below shall have the meanings assigned to them herein except where the context requires otherwise:

- 1.1.1 “Accounting Year” means the financial year commencing from 1 April of any calendar year and ending on 31 March of the next calendar year.
- 1.1.2 “Applicable Laws” means all Law / Laws in force and effect, as of the date hereof and which may be promulgated or brought into force and effect hereinafter in India including any revisions, amendments or re-enactments including without limitation regulations, rules and notifications made there under and judgments, decrees, injunctions, writs and orders of any court or regulators or quasi-judicial body or any appropriate authorities, as may be in force and effect during the subsistence of the Contract. It includes Law/Laws of Country/State legislation, statues, ordinance, notification, circular, regulations and other Laws, and bye Laws of any legally constituted public authority.
- 1.1.3 “Change in Law” means the occurrence of any of the following after the execution of agreement:
- (i) The enactment of any new Indian Law;
 - (ii) The repeal, modification or re-enactment of any existing Indian Law;
 - (iii) The commencement of any Indian Law which has not entered into effect until the date of performance the Contract;
 - (iv) Change in the interpretation or application of any Indian Law by a court as compared to such interpretation or application twenty-eight (28) days prior to the last date of submission of Tender;
 - (v) It also includes changes in the tax rates upward or downward.
- 1.1.4 “Change in Service” means any addition to, deletion from, suspension of or other modification, to the Services, or to the quality, function or as delineated in this agreement, including any such addition, deletion, suspension or other modification, which requires a change in one or more of the service specification and the completion schedule.
- 1.1.5 “Communication” means instruction or information or written notice issued on letter head or through electronic mail exchange between Parties and excludes verbal or short messaging services (SMS). The notice shall be served by delivering a copy by electronic mail, or registered post/speed post etc. Unless otherwise stated in the agreement, all communications to be given under the Contract shall be in writing. Communication may be sent to competent authority or authority delegated to such officer/employee. Communication shall be on letter head of Party signed by competent authority/authorized signatory of the Party.
- 1.1.6 “**Company**/Owner/Purchaser/First Party ” the terms used in this agreement shall refer to BSES RAJDHANI Power Limited (BRPL) having its office at BSES Bhawan, Nehru Place, New Delhi - 110019 and shall include its authorized representatives, agents, successors and assignees.
- 1.1.7 “**Contractor**/Agency/Vendor” means the successful bidder to whom this Agreement is awarded. It is entity named in the Execution Cover and includes assignees, administrator, executors, successors, associated company/subsidiary/joint venture/firm/representative of the Contractor. It is also termed as ‘Contractor’ or ‘Agency’.

- 1.1.8 Contract" /" Agreement/"Work Order" means the agreement between the Company and the Contractor for the performance of the Services, including the Contract / Agreement/ Work Order duly signed and executed between the Parties, the letter of acceptance, the Conditions of Contract, the schedules, Annexures, the Company/BRPL's requirements, including but not limited to the tender, other tender documents and such further documents which are listed in the Contract / Agreement/Work Order and includes any amendment thereto made in accordance with the provisions hereof giving binding effect to the terms and conditions agreed by the Parties. This includes Work Order / Letter of Intent(LOI) issued to the Contractor by the Company/BRPL.
- 1.1.9 "Agreement Period" shall mean duration of Services to be performed and includes extension thereof after mutual consent of both Parties.
- 1.1.10 "Agreement Value/Consideration" means the price of the defined Services including taxes payable to the Contractor for the performance of the Services subject to such additions thereto and deductions there from as may be made under the provisions of this Agreement. The Agreement Value is in consideration of providing the Service by the Contractor as per scope of work and as per Service specifications stipulated in the Agreement; the Agreement Value includes all and any fees, charges, local cess, taxes (GST and Income Tax), levies together with all cost and expenses. The Agreement Value may also term as 'Service Fee(s)' or 'Agreement fees'/Consideration elsewhere in the Agreement. Agreement Value is fixed lump sum for the Agreement Period unless mentioned in Agreement elsewhere.
- 1.1.11 "Force Majeure" shall have the meaning as ascribed in this agreement and annexures thereto.
- 1.1.12 "Good Industry Practice" means the exercise of the highest degree of skill, diligence, prudence and foresight in compliance with the obligations under the Contract which would be expected from a skilled and experienced Contractor engaged, being internationally accepted and customized in day to day performance in industry including for the supply of Manpower.
- 1.1.13 "HSE Conditions" shall mean the BRPL's health, safety and environment conditions containing the requirements and conditions to be met with respect to safety, health and environment.
- 1.1.14 "KPI" shall mean Key Performance Indicator as set out in the Contract/Agreement, its schedules/annexures etc. The performance of the Manpower employed by the Contractor for execution of Services shall be measured through KPI. The payment to Contractor shall be based on Manpower's performance as measured through KPI. It includes metrics in numerical, frequency and measuring process. Total manpower shall be monitored & calculated skill wise but it will be cumulative on monthly basis
- 1.1.15 "Manpower" means a person/s, labour (including Contractor's staff / personnel) known, introduced, security personnel employed and deployed by the Contractor in Contractor's provision of the Services who has skill, efficiency and mannerism to execute, perform Services under this Contract as per Scope Of Work of the Contract. The Manpower deployed shall have valid licenses, PAN card details / KYC information.
- 1.1.16 "Contract cum Performance Bank Guarantee (CPBG)" means the bank guarantee to be procured in accordance with terms of agreement for the performance of the Contractor's obligations under the Contract. The CPBG format is furnished in the Annexure, annexed to agreement.
- 1.1.17 "Service(s)" / "Works" shall mean Company/BRPL's requirements describing in detail including the nature of the Services and activities to be performed by the Contractor and its Manpower, in accordance with specifications, the duration of such requirement, and Services performed, the expected time of commencement and completion, detailed responsibilities and other relevant particulars. It is 'scope of work' which is to be executed, performed successfully and satisfactorily by the Contractor in accordance with the Contract and ancillary services as may be Communicated by the BRPL from time to time under the Contract Period.
- 1.1.18 "Site" means the designated place/office or establishment or construction site, office, branch, including right of way and/or places provided by the BRPL where the Services is to be executed and any other place as may be specifically designated in the Contract/Agreement as forming part of the Site or designated as such by the Company/BRPL.

- 1.1.19 "Sub-Contractor" means a Sub-Contractor whom a part of the Contract is Sub Contracted by the Contractor with the prior written approval of the Company/BRPL, and the permitted legal successors in title to such person, but not any assignee of such person.
- 1.1.20 "Sub-Contract" shall mean obligations under the Contract have been awarded by the Contractor to Sub-Contractor.
- 1.1.21 "Tax Invoice" /" Running Bill" (RA Bill/bill) shall have the meaning ascribed to it under GST Laws.

1.2 Interpretation

In the Contract except where the context requires otherwise:

- 1.2.1 Words indicating one gender include all genders
- 1.2.2 "Written" or "in writing" means hand-written, written, or electronically made and resulting in a permanent record
- 1.2.3 Any reference to any provision of an act of Parliament or of a state legislature shall be construed, at the particular time, as including a reference to any modification, extension or re-enactment thereof, to all instruments, orders or regulations then in force
- 1.2.4 The singular shall include plural and vice versa, and words denoting natural persons shall include partnerships, firms, companies, corporations, joint ventures, trusts, associations, organizations or other entities
- 1.2.5 The headings are inserted for convenience and shall not limit, alter or affect the meaning of the Contract.
- 1.2.6 The terms defined in schedule and the BRPL's Requirements shall have the same meaning ascribed thereto when used elsewhere in the Contract and vice versa;
- 1.2.7 The words "include" and "including" shall be construed without limitation
- 1.2.8 The schedules/annexures shall form an integral part of the Conditions of Contract and shall be in full force and effect as though they were expressly set out in the body of the Conditions of Contract.
- 1.2.9 The word "consent" wherever used, shall mean prior written consent;
- 1.2.10 In the event any portion or all of the Contract is held to be void or unenforceable, the Parties agree to negotiate in good faith to arrive at an amicable understanding which shall accomplish the intent of the Parties as originally set forth in the Contract;
- 1.2.11 No failure on the part of any Party to exercise, and no delay in exercising, any right hereunder shall operate as a waiver thereof, and no single or partial exercise of any such right shall preclude any other or further exercise thereof or the exercise of any other right
- 1.2.12 References to recitals, Articles or schedules in the Contract shall, except where the context otherwise requires, be deemed to be references to recitals, Articles and schedules of or to the Contract; and
- 1.2.13 In case the day on or by which any thing is to be done is not a Business Day, that thing must be done on or by the immediately occurring next Business Day

2. PRIORITY OF CONTRACT DOCUMENTS

The several documents forming the Agreement are to be taken as mutually explanatory of one another, but in case of ambiguities or discrepancies, the same shall be explained and adjusted by the company, who shall, accordingly, issue suitable instructions thereon to the Contractor. In such event, unless otherwise provided in the agreement or explained by way of instructions by the company, as mentioned above, the priority of the documents forming the Agreement shall be as follows:

- i) Contract Agreement/Work Order.
 - (a) Special Conditions of Contract
 - (b) General Conditions of Contract
- (ii) The Letter of Acceptance/ Intent
- (iii) Agreed Minutes of the Tender Negotiation Meetings
- (iv) Agreed Minutes of the Tender Technical Meetings
- (v) The Priced Bill of Quantities

- (vi) The Technical Specifications / Scope of work
- (vii) The Tender document, including all Appendices and/or Addenda, Corrigendum the latest taking precedence.

In the event of any conflict between the above-mentioned documents, the more stringent requirement or conditions which shall be favorable to the company shall govern and the decision of company/BRPL shall be final and binding upon the parties.

3. AMENDMENT

Any modification, amendment or other change to the Agreement shall be affected only by a written instrument signed by the authorized representatives of both, the Company and the Contractor.

4. LANGUAGE AND MEASUREMENT

All correspondence and documents relating to this order placed on the Contractor shall be written in English language. Metric System shall be followed for all dimension, units etc.

5. EXAMINATION OF SITE & LOCAL CONDITIONS

The contractor is deemed to have visited all the sites that comes under Company's licensed area under the Contract and therefore, ascertained all site conditions and information pertaining to the services to be provided under this contract. The company shall not accept any claim whatsoever arising out of the difficulties at site/terrain/local conditions, if any.

6. TAXES & DUTIES

- (i) Prices shall be inclusive of all taxes and duties including labour cess (except GST). However, Income Tax(TDS) as per applicable rate in accordance with Income Tax Act will be deducted from contractor's bills.
- (ii) GST at actual shall be paid extra on submission of GST Registration and self-declaration on Contractor's letter head stating that you have deposited/or will deposit the Tax as per the applicable GST laws. Contractor shall furnish its GST registration number.
- (iii) Any statutory variations i.e. increase/decrease in Taxes / Duties introduced by central Govt. / State Govt. shall be reimbursed/recovered to/from Contractor against documentary evidence and proof.
- (iv) As Per Notification No. 39/2021 # Central Tax dated 21st December, 2021 w.e.f 01/01/2022 registered person (ie, Recipient/Purchaser) can avail tax credit on those invoices only which have been reflected in GSTR 2A or GSTR2B (it means 100% matching of invoice is required). Also, GST has to be deposited by Supplier/Contractor by filing of GSTR- 1 and GSTR-3B.
- (v) In view of above, if the same is not complied with by the supplier/Contractor and the Recipient/Purchaser is not in position to avail / utilize Input Tax Credit due to non-compliance or non-filing of GSTR-1 and GSTR-3B for the month/quarter (as applicable) in which the supply was made, then Recipient/Purchaser has right to hold 100% GST amount from next payment due of the subsequent month till the time default is not cured.
- (vi) For releasing of the payment kept on hold on account of non-compliance of GST Act, supplier/Contractor shall submit payment proof i.e GST Portal screenshot reflecting name of Recipient/Purchaser along with GSTR-1 and GSTR-3B for month/quarter (as applicable) in which the same has been discharged. Payment shall not be released, till the time necessary proof showing the discharge of GST liabilities by the contractors for the period in default are submitted to the Company.
- (vii) Further, the recipient/purchaser shall also be entitled to recover any financial loss suffered by the Company (including tax, interest, penalty and lapse of input credit) due to non-compliance or non-filing of GSTR-1 and GSTR-3B by the supplier/Contractor.
- (viii) In case where delivery of goods is being made on FOR site basis, the Supplier/Contractor is responsible to comply with rules applicable for E-way bill. Any violation in provision of E-way Bill will attract penalty and seizure of Transit Material. Any Penalty and Pre-Deposit due to violation of rules/provision shall be paid and borne by Supplier/Contractor. Also, Supplier/Contractor is responsible to get the goods released from the concerned authority.

Delay in supply due to seizure of goods shall attract liquidated damages as per Order / Agreement provisions.

7. PAYMENT

7.01 All monitoring, measurement, billing & payment processes shall be on IT enabled platform of BRPL as per Company's guidelines issued from time to time and bidders to ensure adherence.

Contractor shall upload bills along with all supporting documents in online BTS (Bill Tracking Systems) software or any other IT enabled platform of BRPL as per Company's guidelines issued from time to time for certification / approval purpose and bidders to ensure adherence. Further the contractor shall also submit original bill (hard copy) along with all supporting documents at Vendor Support Cell of BRPL. The bills shall be made in favor of BSES Rajdhani Power Ltd, BSES Bhawan, Nehru Place, New Delhi - 110019.

7.7 Company shall make payments, without any interest/charges and after deduction of taxes, penalties as applicable, against the bills within 30 days from the date of receipt of the bills, duly verified and certified by Engineer-in-Charge.

7.9 <<Deleted>>

7.9 The bill shall consist of the prescribed documents on standard stationary designed by the Company. Contractor shall collect the details of such documents and formats from the Company.

7.10 Contractor shall, at no point of time, claim or have the right to claim any additional fees, expenses or charges of any nature whatsoever, other than the Rates set out in the contract.

7.11 The company may modify the procedure for the submission of bills. The Contractor shall be obliged to submit its bill as per the procedure stipulated by the company from time to time.

8. TAX INVOICE SUBMISSION PROCEDURE AND CERTIFICATION

8.1 Tax Invoice shall be submitted to the Company for certification. Contractor must pay due attention for submission of Tax Invoice in time and along with relevant Documents to Company.

8.2.1 Tax Invoice shall be certified by Company after verifying relevant original Documents submitted by Contractor. If original Document associated with Tax Invoice is misplaced or lost during transit or for any genuine reason(s) attributable to Contractor, the reason(s) should be informed to Company in writing in stipulated period as instructed by Company. A true copy of certified Document with an indemnity bond or Bank Guarantee, as the case may be, must be submitted in the format provided by the Company.

8.2 Incomplete Tax Invoice will not be considered for processing of payments in terms of the Contract. Company reserves right to recover payable amount or part of Tax Invoice from available financial security or other dues of the contractor with the Company. Contractor shall be paid in terms of the Contract based on certification of Tax Invoice along with associated relevant Document(s) by the Company only.

9. TIME ESSENCE OF CONTRACT

Time is the essence of the contract and the contractor shall be responsible for performance of his works in accordance with the specified schedule. If at any time, the contractor is falling behind the schedule for reasons attributable to him, he shall take necessary action to make good for such delays by increasing his work force or by working overtime or otherwise to accelerate the progress of the work and to comply with schedule timelines and shall communicate such actions in writing to the company, to the satisfaction of the Company that his action will compensate for the delays. The contractor shall not be allowed any extra compensation for such actions.

Time shall be the essence of the Contractor. Contractor shall complete his work in accordance with the specified time-lines/ Schedules as per the terms of the contract or as may be instructed by the Company from time to time.

10. NOT USED

11. INSPECTION & QUALITY CONTROL

Inspection shall be performed by BRPL or its appointed authorized inspection agency. The contractor at his sole expenses shall correct defective works. Such rectification needs to be done / completed within the timelines specified by BRPL.

12. REPORTS AND INFORMATION

The Contractor shall be obliged to submit or furnish to Company, all or any information as desired by company, in the form of a report or otherwise. The report may be required at regular interval as specified/required by company. The information shall be provided in a format to be specified by the company to the Contractor. However, company, reserves the right to revise this format which would be communicated to the Contractor and it shall be valid and binding obligation on the Contractor to submit the desired information in the revised format.

13. STATUTORY OBLIGATIONS

The Contractor shall ensure the due compliance of all the applicable statutory acts, including but not limited to the following acts, where special attention of the Contractor is required to be drawn towards the compliance of provision (along with the latest amendments/additions) including any statutory approval required from the Central/State Governments, Ministry of Labour.

- The Child Labour (Prohibition and Regulation) Act, 1986.
- The Agreement Labour (Regulation and Abolition) Act, 1970.
- The Employee's Pension Scheme, 1995.
- The Employee's Provident Funds and miscellaneous provisions Act, 1952.
- The Employees State Insurance Act, 1948.
- The Industrial Disputes Act, 1947.
- The Maternity Benefit Act 1961.
- The Minimum Wages Act, 1948.
- The Payment of Bonus Act, 1965.
- The Payment of Gratuity Act, 1972.
- The payment of Wages Act, 1936.
- The Delhi Shops & Establishment Act, 1954.
- The Workmen's Compensation Act. 1923.
- The Company's Liability Act, 1938.
- The Sexual Harassment of Women at Workplace (Prevention, Prohibition and Redressal) Act, 2013
- The Delhi Preservation of Trees Act 1994

Further the Contractor shall be liable to comply with all the amendment in existing acts / upcoming new comprehensive labour acts/codes related to applicable labour laws.

The Contractor shall, prior to commencement of the jobs under this agreement, furnish to the Company the Registration No and Codes of permanent Provident Fund and ESI of its employees.

Contractor shall bear the entire responsibility, liability and risk relating to coverage of its workforce under different statutory regulations including Workmen's Compensation Act, ESI Act, Factories Act 1948, the Agreement Labour (Regulation and Abolition) Act 1970, as

amended from time to time, and any other relevant laws/regulations as the case may be. Contractor shall also be solely responsible for the payment of all benefits such as Provident Fund, Bonus, Retrenchment Compensation, leave etc. applicable as per the various statutory laws/regulations and shall keep the Company indemnified in this regard against any claim. The Company shall be entitled to deduct from any money due to or become due to Contractor, any money paid or payable by way of compensation as aforesaid or cost or expenses in connection with any claims thereto and Contractor shall abide by the decision of the Company as regards the sum payable by Contractor under the provisions of this clause

The Contractor shall obtain all registration/permissions licenses etc., which are/may be required under any labour or other legislations for providing the services under this Agreement.

In case it is desired by any Labour authorities to produce the records with respect to salary/ PF/ESI/EDIL/Bonus etc., the said record/register will be made available by the Contractor.

The contractor shall follow all law of the land and prevailing orders issued by various Govt. Departments like Dept. of Power / DERC/ NGT/Dept. of Forest/ Dept. of Environment / DPCB / CPCB/ Court orders etc.

14. REPRESENTATION, WARRANTIES AND GUARANTEES

The Contractor hereby represents warrants and guarantees that:

- 14.1 It is a legally recognized entity under the laws of India;
- 14.2 The Agreement contains valid and binding obligations and is enforceable in accordance with the terms hereof;
- 14.3 It has studied the technical feasibility, Site conditions and other prevailing conditions and all other operational details and based on these studies carried out, has agreed to provide to the Company the services as contemplated in this Agreement;
- 14.4 It has appraised itself of all applicable rules and regulations, and shall at all times comply with such rules and regulations;
- 14.5 It shall procure vehicles and hire manpower suitable for the purposes of rendering services as contemplated in this agreement;
- 14.6 The Services would be conducted in a safe and efficient manner at the Site and at all times in compliance with Good Industry Practices and requirements of the Company, and in any event, in accordance to this Work Order/agreement;
- 14.7 It shall procure all consents, licenses, permits, approvals and certificates and authorizations as may be required from any governmental authority for the performance of services at the Site;
- 14.8 It shall duly pay the duties, taxes and levies as are set out in this agreement or otherwise, which are to be paid by the Contractor;
- 14.9 There is no action, suit or proceeding, at law or in equity, or to the best of knowledge of Contractor, any official investigation before or by any governmental authority, arbitration tribunal or other body pending or, to the best of its knowledge, threatened against or affecting it or any of its property, rights or assets, which could reasonably be expected to have material adverse effect on its ability to perform its obligations under this Agreement or on the validity or enforceability of this agreement.

15. EVENTS OF DEFAULTS

Company may, without prejudice to any of its other rights or remedies under the Contract or

in law, terminate the whole or any part of this Contract by giving written notice to the Contractor, if in the opinion of Company, contractor has neglected to proceed with the Contracts with due diligence or commits a breach of any of the provisions of this Contract including but not limited to any of the following cases:

- 15.1 Failing to complete execution of Contract as per the terms and conditions specified in the Contract.
- 15.2 Failing to complete Contracts in accordance with the approved schedule of Contract.
- 15.3 Failing to comply with any reasonable instructions or orders issued by Company in connection with the Contract.
- 15.4 Failing to comply with any of the terms or conditions of this Contract.
- 15.5 In the event Company terminates this Contract, in whole or in part, on the occurrence of any event of default, Company reserves the right to engage any other vendor or agency to complete the Contract or any part thereof, and in addition to any other right Company may have under the Contract or in law including without limitation, including the right to penalize for delay under clause "Liquidated Damage" of this Contract, the contractor shall be liable to Company for any additional costs that may be suffered/borne by Company for the execution of the Contract.
- 15.6 Failure on the part of the Contractor to maintain its confidentiality obligations and or compromising its integrity, which are required to be of highest standards, in so far as the present scope of work is concerned.

16. RISK & COST

If the Contractor fails to execute the work as per specification/Agreement/as per the direction of Engineer-in-charge within the scheduled period and/or even after the extended period, the company shall be having the right to cancel/terminate the agreement and the company reserves the right to get the work executed from any other source at the Risk & Cost of the Contractor. The Extra Expenditure so incurred shall be debited to/recovered from the Contractor.

17. LIMITATION OF LIABILITY

- 17.1 The Contractor's liability (except Third Party Liability; covered under the agreement and addendums thereto) for all damages, losses, acts or omissions, howsoever occasioned, shall not, at any time exceed an amount equivalent to Contract Value.
- 17.2 Notwithstanding anything stated in the agreement, the limitation of Liability shall not be available/applicable in case of wilful default/breach/negligent act/misconduct on the part of the Contractor and/or its employees.

18. TERMINATION

18.1 TERMINATION BY COMPANY FOR NON PERFORMANCE

During the course of the execution, if at any time the Company observe and forms an opinion that the work under the order is not being performed satisfactory and the performance of the Contractor not found satisfactory, the Company reserves its right to cancel/ terminate this Agreement giving 30 days' notice without assigning any reason and the Company will recover all damages including losses occurred due to loss of time from the Contractor. After termination of the agreement, the Contractor shall immediately stop all activities related to the work terminated. This is without prejudice to other rights under the terms of contract. The Contractor shall hand over the Company all drawing/documents prepared for this contract up to the date of cancellation of order.

18.2 PREMATURE TERMINATION

The order can be terminated by the Company before the expiry of its term under the following conditions:

- (i) The Contractor repudiates this order or otherwise evidences intention not to be bound by this order;
- (ii) The Contractor assigns, mortgages, or charges or purports to assign, mortgage, or charge any of its obligations or rights in contravention to the provisions of this order; or, transfers or negates any of its obligations in contravention to the provisions of this order.
- (iii) The Contractor breaches the Secrecy/Non-disclosure Clause/Confidentiality obligations.
- (iv) If at any stage during the tenure of the work order, Contractor is found to be involved or indulging or even attempting illegal, unlawful action or activities or some fraudulent or even trying to take or ask bribe from any customer or to give bribe official/staff or misuse or abuse any meter or property of the Company.
- (v) The Company shall be entitled to deduct from any money due or to become due to the Contractor, money paid or payable by way of compensation as aforesaid or cost or expenses in connection with any claims thereto. The Contractor shall abide by the decision of the Company as to the amount payable by the Contractor under the provision of this clause.

18.3 TERMINATION BY COMPANY FOR CONVENIENCE

The Company shall, in addition to any other right enabling it to terminate the Contract, have the right to terminate the Contract at any time without assigning any reason, by giving a written notice of minimum 30 days to the Contractor. The Contract shall stand terminated on the date as per the notice but such termination shall be without prejudice to the rights of the Parties accrued on and before the date of termination.

19. GOVERNING LAW AND ARBITRATION

19.1 Governing Law: This Work Order/Agreement shall be governed by the laws of India and each party submits to the exclusive jurisdiction of the courts in New Delhi.

19.2 Dispute Resolution Mechanism. All disputes and differences arising out of or in connection with this Agreement shall be resolved amicably by mutual discussion within 30 days. If the dispute cannot be resolved by mutual discussions and agreement, the parties will take such dispute to an arbitral panel comprising Sole Arbitrator jointly appointed by the parties to agreement.

19.3 In the event parties fail to appoint the sole arbitrator within 30 days from the date of request made by party, the Sole Arbitrator shall be appointed as per the provisions of The Arbitration and Conciliation Act 1996 as amended upto date. The arbitration shall be conducted in New Delhi in accordance with the provisions of the Arbitration and Conciliation Act 1996. The award of the arbitral panel shall be final and binding on all parties. The arbitration proceedings shall be conducted in English. The venue and seat of Arbitration shall be in Delhi Only. The cost of arbitration shall be shared equally between the parties unless otherwise directed by the Arbitrator.

20. FORCE MAJEURE

20.1 General

An "Event of Force Majeure" shall mean any event or circumstance not within the reasonable control, of the Party affected, but only if and to the extent that:

- (i) Such event or circumstance, despite the exercise of reasonable diligence, could not have been prevented, avoided or reasonably foreseen by such Party;
- (ii) Such event or circumstance materially and adversely affects the ability of the affected Party to perform its obligations under this agreement, and the affected Party has taken all

reasonable precautions, due care and reasonable alternative measures in order to prevent or avoid the effect of such event on the affected party's ability to perform its obligations under this Agreement and to mitigate the consequences thereof. For the avoidance of doubt, if such event or circumstance would not have materially and adversely affected the performance of the affected party had such affected party followed good industry practice, such event or circumstance shall not constitute force majeure.

(iii) Such event is not the direct or indirect result of the failure of such Party to perform any of its obligations under this Agreement; and

(iv) Such Party has given the other Party prompt notice describing such events, the effect thereof and the actions being taken in order to comply the relevant clause

20.2 Specific Events of Force Majeure

Subject to the provisions of the agreement, Events of Force Majeure shall include only the following to the extent that they or their consequences satisfy the above requirements:

- (i) The following events and circumstances:
 - a. Effect of any natural element or other acts of God, including but not limited to storm, flood, earthquake, lightning, cyclone, landslides or other natural disasters, and
 - b. Explosions or fires or flood
- (ii) Public disorder, insurrection, rebellion, sabotage, riots or violent demonstrations of a local character;
- (iii) Declaration of the Site as war zone.
- (iv) Any order, regulation, directive, requirement from any Governmental, legislative, executive or judicial authority.

20.3 Notice of Events of Force Majeure

If a force majeure event prevents a party from performing any obligations under the Agreement in part or in full, that party shall:

- (i) Immediately notify the other party in writing of the force majeure events within 2 working days of the occurrence of the force majeure event
- (ii) Be entitled to suspend performance of the obligation under the Agreement which is affected by force majeure event for the duration of the force majeure event
- (iii) Use all reasonable efforts to resume full performance of the obligation as soon as practicable
- (iv) Keep the other party informed of all such efforts to resume full performance of the obligation on a regular basis
- (v) Provide prompt notice of the resumption of full performance or obligation to the other party.

20.4 Mitigation of Events of Force Majeure

The Contractor shall:

- (i) Make all reasonable efforts to prevent and reduce to a minimum and mitigate the effect of any delay occasioned by an Event of Force Majeure, including applying other ways in which to perform the agreement;
- (ii) Use its best efforts to ensure resumption of normal performance after the termination of any Event of Force Majeure and shall perform its obligations to the maximum extent practicable as agreed between the Parties; and
- (iii) Keep the Company informed at regular intervals of the circumstances concerning the event of Force Majeure, with best estimates as to its likely continuation and what measures or contingency planning it is taking to mitigate and or terminate the Event of Force Majeure.

20.5 Burden of Proof

In the event that the Parties are unable in good faith to agree that a Force Majeure event has occurred to an affected party, the parties shall resolve their dispute in accordance with the

provisions of this agreement. The burden of proof as to whether or not a force majeure event has occurred shall be upon the party claiming that the force majeure event has occurred and that it is the affected party.

20.6 Termination for Certain Events of Force Majeure

If any obligation of any Party under the Agreement is or is reasonably expected to be delayed or prevented by a Force Majeure event for a continuous period of more than 1 (one) month during the Term of the Agreement, the Agreement shall be terminated at the discretion of the Company and neither Party shall be liable to the other for any consequences arising on account of such termination.

The Company reserves the right to demand the Contractor's services on holidays as well as beyond the normal working hours.

The Contractor will ensure that none of their person is engaged in any unlawful activities subversive of the Company's interest failing which suitable action may be taken against the Contractor as per the terms and condition of this order.

The Contractor shall be liable for payment of all taxes and duties as applicable, to the State/ Central Govt. or any local authority.

The Contractor's employees shall not be treated as Company's employees / persons for any purpose whatsoever & facilities/ benefits applicable to the Company's employees shall not be applicable to Contractor's employees. If due to any reasons whatsoever the Company is made liable to meet any obligation under any of the laws & enactment etc, for any reason whatsoever the same shall be recovered from the Contractor either from the present and future amount payable to him or as per law.

21. NOTICE & COMMUNICATION

Any notice or other formal communication to be given under this agreement shall be in writing and signed by or on behalf of the party giving it and shall be sent by registered post, A.D. to the addresses of Contractor or BRPL as mentioned herein above or to any other addresses as agreed by the parties, in writing from time to time.

Any notice or other formal communication can also be sent through official e-mail ID of authorized person of Contractor or BRPL.

22. SAFETY CODE

22.1 The Contractor shall ensure adequate safety precautions at site, as required under the law of the land to facilitate safe working, during the execution of work under agreement/work order and shall be entirely responsible for the complete safety of their workmen as well as other workers at site and premises during performance of work under agreement.

22.2 The Contractor shall observe the safety requirements as laid down in the agreement and in case of sub-contract/assignment (only after written approval of company), it shall be the responsibility of Contractor that all safety requirements are followed by the employees and staff of the sub-contractor.

22.3 The Contractor employing two hundred employees or more, including employees deputed under agreement, shall have a safety officer in order to ensure the implementation of safety requirements of the agreement and if the Contractor having lesser number of employees, including agreement workers, shall nominate one of its employees to act as safety coordinator who shall liaise with the safety officer on matters relating to safety and his name shall be displayed on the notice board at a prominent place at the work site.

- 22.4 The Contractor shall be responsible for non-compliance of the safety measures, implications, injuries, fatalities and compensation arising out of such situations or incidents.
- 22.5 In case of any accident, the Contractor shall immediately submit a statement of the same with BRPL and the safety officer, containing the details of the accident, any injury or casualties, extent of property damage and remedial action taken to prevent recurrence and in addition, the Contractor shall submit a monthly statement of the accidents to BRPL at the end of each month.
- 22.6 The contractor / safety officer shall be responsible for providing training to all staff & workers, safety compliances, testing and fitness of all T&P, PPE, annual safety audit reports etc. in line with CEA norms.

23. CONTRACTOR'S OBLIGATIONS

- 23.1 The performance of Services as completed by the Contractor shall be wholly in accordance with the Contract and fit for the purposes for which they are intended to and as defined in the Contract. The Services shall include any Service which is necessary to satisfy the Company's requirements and as implied by the Contract.
- 23.2 The Contractor shall execute the Services within the time frame for completion as specified in the order/agreement and Scope of Work. Without prejudice to the provisions of the Contract, before commencing the Services, the Contractor shall satisfy itself regarding the BRPL's requirements. The Contractor shall give notice to BRPL, within forty-eight (48) hours of the receipt of BRPL's requirements, of any error, fault or other defect in the BRPL's requirements or such items of reference.
- 23.3 The Contractor takes full responsibility for the adequacy and stability of Services to be performed at the Site.
- 23.4 The Contractor shall at all times endeavour to adopt best practices as is prevalent in like industry and shall always be required to achieve the desired quality and confirm to the schedule of Service(s) at no additional cost to the company/BRPL.
- 23.5 The Contractor is deemed to have satisfied itself as to the correctness and sufficiency of the BRPL's requirements and other terms of the Contract relating to its risks, liabilities and obligations set out in or implied by the Contract and all matters and things necessary for the proper performance of the Services.
- 23.6 The Contractor shall, whenever required by the BRPL, submit details of the arrangement and methods which the Contractor proposes to adopt for the performance of the Services. No alteration to these arrangements or methods shall be made without the approval of BRPL.
- 23.7 Contractor agrees to provide all preliminary information or data as may be required by the Company/BRPL within fifteen days of issuance of the signed LOI/Work order or as per mutually agreed timelines.
- 23.8 In case the Contractor comes across with any ambiguity and/ or discrepancy in the BRPL's requirements, it shall immediately Communicate such ambiguity and/ or discrepancy to BRPL, for seeking appropriate instructions to resolve such ambiguities and discrepancies.
- 23.9 Contractor to maintain sufficient cash flow as working capital to meet daily expenses for the Manpower.
- 23.10 The Contractor shall not use the name of the company/BRPL in any manner for credit arrangement or otherwise and it is agreed that the company/BRPL shall not in any way be

responsible for any debts, liabilities or obligations of the Contractor or its Manpower.

24. INDEMNITY

The Contractor shall indemnify, defend, save and hold harmless all directors, company and its employees against any and all suits, proceedings, actions, demands and third party claims for any loss, damage, cost and expense suffered by company on account of the negligence, act or omission inaction by the Contractor or its employees under this Agreement. Agencies shall also wholly indemnify and compensate company against any theft, misappropriation, fraudulent act or omission, any collusion with customer/s, intentional recording of incorrect reading/DATA, or any other offence under the applicable laws or breach of obligation under the present agreement, and would also render itself liable to appropriate legal action being initiated against it by company.

The Contractor shall also be responsible and liable to company for any loss or damage caused to company for any negligence or inaction, damage to the property of company caused by the Contractor or its employees.

25. SECRECY & CONFIDENTIALITY

- 25.1 The technical information, data and other related documents forming part of order and the information obtained during the course of investigation under this order shall be the Company's exclusive property and shall not be used for any other purpose except for the execution of the order. The technical information drawing, records and other document shall not be copied, transferred, or divulged and/or disclosed to third party in full/part, not misused in any form whatsoever except to the extent for the execution of this order.
- 25.2 These technical information, drawing and other related documents shall be returned to the Company with all approved copies and duplicates including data/drawing/plans as are prepared by the Contractor during the executions of this order, if any, immediately after they have been used for agreed purpose.
- 25.3 In the event of any breach of this provision, the Contractor shall indemnify the Company against any loss, cost or damage or claim by any party in respect of such breach.
- 25.4 The Contractor shall not use the name/logo/emblem of the Company in any manner either for credit arrangement or otherwise and it is agreed that the Company shall not in any way be responsible for the debts, liabilities or obligations of the Contractor and/or his employees.
- 25.5 The Contractor hereby covenant that the Contractor shall be responsible for theft, if any committed, by his staff and the Contractor shall indemnify Company from and against all claims, demands, actions, suits and proceedings, whatsoever that may be brought or made against the Company by or on behalf of any person, body, authority whatsoever and whomsoever and all duties, penalties, levies, taxes, losses, damages, costs, charges and expenses and all other liabilities of whatsoever nature which the Company may be liable to pay, incur or sustain by virtue of or as a result of the performance or non- performance or observance or non- observance by the Contractor of any of the terms and conditions of this agreement. The Company shall have full power and rights at its discretion to pay or defend or compromise any suits, claims or demands brought or made, whether pending or threatened touching upon this agreement as it may consider necessary or desirable and shall be entitled to recover from the Contractor all sums of money including all legal costs, charges and expenses incurred by virtue of any such compromises which shall not be called into question by the Contractor but shall be final and binding on the Contractor.
- 25.6 Contractor shall submit signed NDA as per the format 4.3 attached.

26. NON-EXCLUSIVITY

The award of the work order/agreement to the Contractor shall not preclude the Company from awarding the same order for similar work at the same rates, or on any terms and

conditions to other party or parties. The Company at its discretion may place the order on any other party.

27. SEVERABILITY

If any provision of this Agreement is or becomes invalid or unenforceable by the courts of any jurisdiction to which it is subject, such invalidity or unenforceability shall not prejudice the remaining provisions of this Agreement, which shall continue in full force and effect.

28. ASSIGNMENT & SUBLETTING

The Contractor shall not, without company's prior consent in writing assign or sublet or transfer any portion of services awarded to the Contractor as envisaged herein and falling under this contract. Moreover, any such consent shall not relieve the Contractor from any obligation, responsibility, or duty under this Contract.

29. ASSIGNMENT BY THE COMPANY

The rights and obligations of BRPL under the Contract shall be assignable to Affiliates, associate company, joint venture or any other company including change in Management Control and BRPL's lenders without consent of the Contractor. Upon written notice of seven Business Days (07 days) by BRPL, the Contract shall be deemed to have been assigned to the third party under this Article. This Article fulfils its meaning notwithstanding the notice is not accepted by the Contractor and BRPL shall not be obliged to the Contractor after seven days (07) of issue of any further notice.

30. NO JOINT VENTURE

The Contractor shall not constitute a joint venture, consortium or other unincorporated grouping of two or more Persons, following the execution of the Contract.

31. WAIVER OF RIGHTS

No delay or forbearance by company in exercising any right or power under this Agreement shall be construed as a waiver of such right or power, nor shall any single or partial exercise of such right or power preclude any further exercise of such right of power.

32. THE COMPANY'S RIGHT TO VARY QUANTITIES

The Company reserves the right to vary the quantity i.e. increase or decrease the Numbers/ quantities without any change in terms and conditions during the execution of the Order. BRPL may increase or reduce the area/ scale of operations after starting of execution of the contract and the size of contract may be adjusted accordingly.

33. VENDOR CODE OF CONDUCT

Contractor confirms to have gone through the Policy of BRPL on legal and ethical code required to be followed by Vendors encapsulated in the "Vendor Code of Conduct" displayed on the official website of BRPL (www.bsesdelhi.com) also, which shall be treated as a part of the agreement.

Contractor undertakes that he shall adhere to the Vendor code of Conduct and also agrees that any violation of the Vendor Code of Conduct shall be treated as breach of the agreement. In event of any such breach, irrespective of whether it causes any loss/damage, company (BRPL) shall have the right to recover loss/damage including liquidated damages from Contractor.

The Contractor hereby indemnifies and agrees to keep indemnified the company (BRPL) against any claim/litigation/liability/penalty including litigation cost arising out of any violation of Vendor Code of Conduct by the Contractor or its officers, agents & representatives etc.

34. DISCLOSURE OF RELATIONSHIP

The Contractor acknowledges & undertakes that the Contractor or any partner of the Contractor or director of the Contractor is not related to any of the officers of the Company or

the Company's Representative, or alternatively, is a close relative of an officer of the Company or the Company's Representative and has no financial interest/stake in the Company's business. The Parties agree that breach of the above provisions shall entitle the Company to terminate the Contract under Clause 23, without payment of any compensation to the Contractor. The Contractor agrees and acknowledges and shall ensure that its employees, directors and partners do not develop any such interest during the Contract Period.

35. MSME

- 35.1 If the Contractor is covered under the definition of supplier/Contractor under the purview of Micro, Small & Medium Enterprises Development Act, 2006, it shall declare so at the time of its registration as vendor with the Company failing which it will be presumed that it is a non-MSME unit.
- 35.2 Contractor shall provide to Company the proof of classification of its enterprise and filing memorandum with the authorities concerned under the Micro, Small & Medium Enterprises Development Act, 2006 (herein referred to as "the MSMED Act") within one week of receipt of the Contract
- 35.3 The Contractor further declares and undertakes to intimate Company of any change in its status or constitution under this section from time to time under this Contract. The Contractor must provide MSME registration number along with PAN card and GST registration number on Tax Invoice failing which the Contractor shall not claim any benefit under the MSMED Act.
- 35.4 The Contractor to furnish the undertaking to the Company in this regard.

36. COVID GUIDELINES

Looking to the prevailing Covid19 situation, Contractor will ensure that the work carried out in the field by their staff shall be as per the guidelines issued by MHA / BRPL/ Engineer-in-charge from time to time. Further Contractor shall be required to provide to their staff masks/ sanitizers/ all PPEs required for working in Covid19 situation. The Contractor shall further ensure to work as per the guidelines issued by BRPL and the instruction of the Engineer in charge.

37. CLEANLINESS & PRECAUTIONS TO BE TAKEN WHILE DOING WORK AT SITE TO PREVENT DUST POLLUTION

All debris shall be removed and disposed of at assigned areas on daily basis. Surplus excavated earth shall be disposed of in an approved manner. In short, the contractor shall be fully responsible for keeping the work site clean at all times. In case of non-compliance, company shall get the same done at Contractor's risk and costs.

While carrying out any civil work including road/ pit digging, plinth/ fence making, road restoration etc. contractor shall adhere to below mentioned guidelines.

- (a) No construction material/ debris shall be stored on metalled road.
- (b) Wind breakers of appropriate height on all sides of ear marked area using CGI sheets shall be raised to ensure that no construction material dust fly outside ear marked area.
- (c) The construction material i.e. coarse sand, stone aggregates, excavated earth, cement and any other material to and from the site shall be transported under wet and covered condition to ensure their non-slippage en-route to avoid air contamination.
- (d) The contractor shall provide mask and helmet to every worker working on the construction site and involved in loading/unloading and carriage of construction material and construction debris to prevent inhalation of dust particles.
- (e) Over loading of vehicles shall be strictly prohibited
- (f) The construction material at site shall be stored under wet and covered condition.
- (g) The dumping sites for temporarily storing the excavated earth shall be properly levelled, watered and rehabilitated by plantation to avoid flying of dust.

- (h) The worker at the site shall be sensitized to adopt / observe the dust controlled measures in true spirit.
- (i) If any C&D(Construction& Demolition) waste is generated at site, the same will be transported to the C&D waste site only and the record for the same will be maintained by the agency.
- (j) Wet jet in grinding and stone cutting is being permitted at site.
- (k) The necessary record for dust control is being maintained by the department on day to day basis and being monitored regularly.
- (l) Contractor shall ensure that no tree shall be harmed and no tree roots shall be destroyed/cut while performing the task under agreement.
- (m) The contractor shall comply the provisions of The Delhi Preservation of Trees Act 1994. The Execution contractor shall be responsible for all the preventive and protective environmental steps as per guidelines. Any violations from the above guidelines have been viewed very seriously by the authorities. Contractor shall be liable for the penalties / other action by the authorities, the contractor shall indemnify BRPL from all liabilities on this account.

38. ENVIRONMENTAL, HEALTH & SAFETY

The Contractor will ensure that the Environment, Health & Safety (EHS) requirements are clearly understood and faithfully implemented at all levels at site as per instruction of Company/BRPL. Contractors must comply with the requirements, as follows:

- (i) Comply with all of the elements of the EHS Plan and any regulations applicable to the work
- (ii) Comply with the procedures provided in the interests of Environment, Health and Safety
- (iii) Ensure that all of their employees designated to work are properly trained and competent
- (iii) Ensure that all plant and equipment they bring on to site has been inspected and serviced in accordance with legal requirement and manufacturer's or supplier/Contractor s' instructions
- (iv) Make arrangements to ensure that all employees designated to work on or visit the site present themselves for site induction prior to commencement of work
- (v) Provide details of any hazardous substances to be brought onsite
- (vi) Ensure that a responsible person accompanies any of their visitors to site.

38.1 Measures related to the Tree Pruning, excavation near tree and construction & demolition:

Notwithstanding anything stated in the tender document, work contract or any other communication issued related to the performance of the work order awarded, it is clarified that the vendor and its associate/employees/worker, during the performance of work under this work order(s), shall ensure full compliance of the provisions of all environment laws/rules/directions by any authority including judicial authority/ regulation related to excavation near tree and construction & demolition activity, and shall mandatorily comply the following instructions:

A. Tree Pruning, Planning, Installation and Maintenance of Utility Apparatus in proximity to trees shall be done mandatorily by ensuring the following prescribed measures:

- 1) No excavation work shall be done within two (2) meters of the Tree Trunk.
- 2) Any exposed roots beyond 2 meters of the tree trunk, should be protected with dry sacking and backfilling must be done with a suitable manure mixture and/or the compost material mix as soon as possible on the completion of the works.
- 3) For any excavation to be carried out beyond the prescribed distance of 2 meters but within 3 meter from the tree trunk, manual methods (by use of hand) or by using trenchless techniques shall be preferred over use of a mechanical excavation.
- 4) No roots shall be cut during the excavation work.
- 5) Not to lean any materials against or chain mechanical plants to the trunk of the trees.
- 6) Avoid any soil contamination from oil, gasoline, paint and paint thinner or other chemicals.
- 7) No concrete or construction or repairing work shall be done at least within two (2) meter radius of the trunk of trees.
- 8) All the electric wires and high tension cables and other apparatus relating to supply of

electricity shall permanently be removed from the trees branches.

Records to be maintained by the supervisor to demonstrate adherence to the guidelines for excavation in Proximity to the Trees:

- 1) Ensure pre and post photography and videography of the site demarcated for the excavation work and the same shall not be deleted/removed until securing the prior permission of the Circle head O&M.
- 2) While digging and upon exposure to the roots- take immediate photographs of the same and report the matter to senior officers for further guidance.

If any unauthorized layering of other cables is being carried out at the digging site by some other agency/person, then immediately capture photographs of the same and inform the seniors, who shall take suitable legal actions, if required, which includes intimating to tree officer about such unauthorized laying of wires by such agency.

B. DUST MITIGATION MEASURES FOR CONSTRUCTION & DEMOLITION ACTIVITIES

Any construction/demolition/excavation related activity performed in furtherance of the performance of work under award, be undertaken only after ensuring the Dust Mitigation Measures prescribed as follows:

- 1) Dust/wind breaking walls of appropriate height around the periphery of the construction site.
- 2) Installation of Anti Smog Gun(s) (for >20,000 m² built up area).
- 3) Tarpaulin or green net on scaffolding around the area under-construction and the building.
- 4) All vehicles including carrying construction material and construction debris of any kind should be cleaned and wheels washed.
- 5) All vehicles carrying construction material and construction debris should be fully covered and protected.
- 6) All construction debris and construction material of any kind should be stored on the site and not dumped on public roads or pavements.
- 7) No loose soil or sand or Construction & Demolition Waste or any other construction material which may cause dust, shall not be left uncovered.
- 8) No grinding and cutting of building materials in open area. Wet jet should be used in grinding and stone cutting.
- 9) Unpaved surfaces and areas with loose soil should be adequately sprinkled with water to suppress dust.
- 10) Roads leading to or at construction sites must be paved and blacktopped i.e., metallic roads (for >20,000 m² built up area).
- 11) Construction and demolition waste should be recycled on-site or transported to authorized recycling facility and due record of the same should be maintained.
- 12) Every worker working on construction site and is involved in loading, unloading and carriage of construction material and construction debris should be provided with dust-mask to prevent inhalation of dust particle.
- 13) Arrangement should be provided for medical help, investigation and treatment to workers involved in the construction of building and carry of construction material and debris relating to dust emission.
- 14) Dust mitigation measures shall be displayed prominently at the construction site for easy public viewing.
- 15) Ensure the compliance of all dust control measure.

It is clarified that BRPL has zero tolerance with respect to the non-compliance/breach of environment laws/rules/directions by any authority including judicial authority/ regulation. Accordingly, in case of breach by the vendor/its associate/employee/worker to the laws/rules as detailed above, shall be termed as serious breach to the terms of work order and BRPL shall be free to take all actions against vendor for such breach of contract including the termination of the said contract. Additionally, the vendor shall also be liable to indemnify BRPL/its Directors/Officers/Employees/Associates in full including the payment of all loss/penalties/compensation including environment compensation as imposed by any judicial/quasi-judicial citing/alleging such breach.

The vendor shall also be under a mandate to provide an Undertaking to BRPL, which includes that the excavation, tree pruning, construction and demolition work, if performed by

such vendor, the same shall be in strict adherence of all environment laws/rules/directions by any authority including judicial authority/ regulation and all the measures provided in work order/tender under the head/title "Measures related to the Tree Pruning, excavation near tree and construction & demolition".

39. ACCEPTANCE

Acceptance of the CONTRACT implies and includes acceptance of all terms and conditions enumerated in the CONTRACT, in the technical specification and drawings made available to the Contractor consisting of general conditions and complete scope of work.

Contractor's and Company's contractual obligations are strictly limited to the terms set out in the CONTRACT.

Annexure:

Undertaking from the _____(Vendor- undertaking the excavation work)
I _____, Proprietor of M/s _____, having R/o. at _____

Has been awarded a work order no. _____, dated _____, from BSES Rajdhani Power Limited (BRPL), to carry out digging/excavation work on the stretch of road detailed in the work order.

Details of the Road cutting permission are RCP no. _____ dated _____ valid from _____ to _____ on the stretch of road detailed in the work order.

I have read the Guidelines on Excavation (as enclosed) and understood the same in sense and sprit. I assure that I shall abide with the said guidelines along with the all other provision associated with laws relating to laying of cables under the said work order.

I do herby undertake that I shall be fully responsible for any violation of any kind and shall be liable for any cost consequences, penalty, liability, damages if imposed by any authority court citing/disputing the performance of the task.

I further undertake to indemnify BRPL its officers, directors, employees and associates from any cost consequences, penalty, liability, damages if imposed by any authority court citing/disputing the performance of the task.

I do herby agree and confirm that forming a part of work order/agreement and breach of this undertaking shall be termed as breach of the terms of the said work order/agreement.

I have read and understood the terms of this undertaking and submitting this undertaking out of my own accord and without any coercion.

Deponent

SECTION – V :SCOPE OF WORK

SECTION-V
SCOPE OF WORK

SCOPE OF WORK:

The scope includes material transportation, GPR Survey of Route, digging of trench, cable laying, Supply and Laying HDPE Pipes, cable cover, Backfilling levelling of trench, Covering of Malba, Dust mitigation Measures at Site, close Barricading, Removal of Surplus Malba, Fabrication and Erection of Steel Structure, Supply & Installation of LIU, OFC laying, Termination etc.

Scheme No: EW22GS4011 for LILO of 66kV Tikari Kalan (Mundka) - Nilothi Grid Ckt 1 & 2 at New Proposed Cable Laying for 66kV Bakkarwala Grid.

Note:

While carrying out trenchless / open digging works the existing underground cables are liable to get damaged leading to High Risk Safety Hazard to the working people. To arrest above problem to the best degree possible, there are technology support available, like Cable Route Tracer which is an important tool to detect the live / dead cables underground to the depth upto 3 meters, comfortably. The vendor must employ Cable Route Tracer before start of excavation / trenchless job and submit reports to the Engineer-in-charge for clearance to start the job. The above will minimize the risk of cable damage and improve safety of the working people.

It may please be noted that in case bidders have no "Cable Route Tracers" with him, as a basic necessity tool. Heavy penalty will be imposed on the vendors, if the vendor damages the cables. The preferable make for the Cable route tracer shall be 3M or equivalent make.

Also, Cable laying should be as per BRPL technical specifications and erection of free issue materials, Transportation, loading, unloading from BRPL Store to Site, Temporary storage at site, assembly, erection, structural, complete pre-commissioning checks , testing and commissioning at site , obtaining statutory clearance & certification from state electrical inspector, Municipal Corporation department (if required), Fire Officer (if required), Horticulture department (if required), and handing over to owner after successful testing & Commissioning of Bay at BRPL, New Delhi .Schedule of work shall be as per BOQ attached herewith.

After completion of E/T/C work of the scheme, Bidder has to obtain the Electrical Inspectorate's Clearance/Safety Clearance from the Electrical Inspector of Delhi Govt./Safety Inspector BRPL(whichever is applicable) Electrical Inspector Clearance fees shall be in Bidder's scope. The related fees, payments and pursuance work shall be in scope of Bidder only. The contractor has to obtain Electrical Inspectorate's clearance/ Safety Clearance from Safety Inspector BRPL of the installation and to be handed over to Engineer in charge.

Bidders should have basic testing equipments like PC Set, Sheath Fault measurement Kit, Meggar Kit, available with his company & shall submit the list of tools & tackles, with SI No, Make & Calibration certificates suitable for carrying out the specified job tendered for.

All loading/unloading, of materials at work-site shall be Bidder's responsibility. Involvement of Crane/Hydra/Tractor/Trailer for this type of work shall be in your scope. Adequate weather protection shall be provided by the Bidder to keep the materials safe from sun & rain by providing covered

storage space as well as using tarpaulins.

All the labour, cranes, power, tool and tackles, technical supervision etc. are including in your scope of work. Adequate number of engineers, supervisors and labours shall be posted at site and the list of the same along with certificate of Qualification of technical staff should be submitted by the Contractor to the Company for checking the adequacy immediately after award of contract.

However, Engineer In-Charge shall arrange any permission like Road cutting clearance etc. from the Delhi Civic authorities like MCD, DDA, PWD, DJB and Traffic Police. However, the contractor shall make follow up with local authorities and other connected persons that may be required to carry out the job under this order.

The Bidder shall also make his own arrangement for the accommodation/conveyance requirements for its staff at site. Company will be provided at site the adequate open space for Bidder's site store for storing the materials, tools, tackles etc. The entire Bidder's storage will be within the site premises. All the incoming and outgoing materials, equipment, tools, tackles and any other items related to said work shall be entered into the register kept for this purpose and shall be in the custody of Bidder, however company does not hold any responsibility for any loss or damage of Bidder's material etc.

The Bidder at his own shall arrange Water and Electricity Power at his cost.

Major materials like 33KV cable, 33KV straight through joints, 33KV I/D or O/D end Termination, Structural Steel etc. will be issued by BRPL as free issue item. However transportation of all free issue materials from BRPL stores to BRPL S/S, handling, safe storage till handing over of the installations shall be in the scope of the contractor.

FREE ISSUES OF MATERIAL AND /OR EQUIPMENT:

The Purchaser issued Free Issue Material/Equipment to Vendor in order that Vendor may fulfill its obligations under the Agreement, shall remain the property of Purchaser and shall be clearly labeled as such by Vendor until handing over of the completed installations in accordance with the terms of the Agreement. Risk of loss in respect of all such Free Issue Items shall pass to Vendor upon receipt of such terms by Vendor and remain with Vendor until handing over of the completed installations to Purchaser in accordance with the terms of the Agreement. Vendor shall maintain all such Free Issue Items in good condition and shall use them solely in connection with the requirements of the Agreement.

Special Instruction:-

- a. CES shall consider completion certificate of different projects (which shall be submitted by bidders in support to PQR) as a performance certificate during tender evaluation.
- b. All Erection tools and tackles and testing equipment shall be available with Bidder in event of order.
- c. Penalty clause shall be incorporated in case any of workmen of Bidder is found violating safety protocol as per GCC-ETC LD Clause no 15.
- d. GTP & drawing approval before procurement & inspection of the ready material before dispatch shall be done by CES-BRPL.
- e. 1.1 Continuous Metal Barricades:-
 - 1) Vendor shall demonstrate to BRPL Engineer in Charge, ready availability of Metal Barricades (With Specifications as per BSES Standards for continuous barricading) within 15 Days of Order Award. Barricades not conforming to BRPL specification shall be summarily rejected.

2) BRPL will permit Excavation only after Minimum Length of Barricades is made available at Site.

Minimum Length of Barricades: Must be equal to the Route Length of Cable Laying OR 600 MTR (2 Runs X 300 MTR), whichever is Lower. Thus:-

a) If Route Length of Cable Laying is < 600 MTR, then Min-m Length of Barricades to be made available at Site = Actual Route Length,

b) If Route Length of Cable Laying is > 600 MTR, then Min-m Length of Barricades to be made available at Site = 600 MTR

3) Non-compliance of above will lead to immediate termination of Contract and may also result in - a) Forfeiture of Security Money b) Disqualification from future Tender participation for a Min-m 1 Year Period ".

f. All Erection tools and tackles and testing equipment shall be available with Bidder in event of order.

g. Penalty clause shall be incorporated in case any of workmen of Bidder is found violating safety protocol as per GCC-ETC LD Clause no 15.

h. From each lot of HDPE Pipe, a sample will be sealed by Site in-charge/Execution Engineer in presence of Vendor representative and sent to any laboratory as per BRPL Engineer-In-Charge's instruction. Cost of testing will be paid by the Concerned Vendor. Also, strict action will be taken against the vendor does not conform to BRPL specification.

i. HDPE tech spec is also attached for your further process.

j. HDPE type-- PN6 PE80

k. Length -- As per site requirement

l. Diameter -- As per attached Technical Specification

m. Make -- Flow well, Tirupati, Naredra Poly Plast, Eon Plast

n. Type test & Printing -- As per attached Technical Specification

o. GTP & drawing approval before procurement & inspection of the ready material before dispatch shall be done by CES-BRPL.

6. ADDITIONAL SCOPE / WORK:

Any additional work beyond the scope enumerated in the work order above shall be carried out as per the instructions of Engineer-In Charge. The company shall not entertain any claim or increase in the Work Order value due to execution of such additional work if the same is not approved by Engineer In Charge.

SECTION – VII: PRICE BID

BSES

SECTION – VII: PRICE BID

SERVICE BOQ

Scheme No: EW22GS4011

Estimate for LILO OF 66KV TIKARI KALAN (MUNDKA) - NILOTHI GRID CKT 1 & 2 AT NEW PROPOSED CABLE LAYING FOR 66KV BAKKARWALA GRID.

SR No	SERVICE CODE	DESCRIPTION	UNIT	QTY	RATE	AMOUNT
1	4060426	Transportation of electrical equipment from store/any site in Delhi to site of work in Delhi including loading and unloading at both ends manually.(Considering max lead of 50KM)	TRP	45		
2	4060425	Transportation of electrical equipment I.e.CB,CT,PT,ISOLATORS,LA,CABLE DRUMS etc. from store/any site in Delhi to site of work in Delhi including loading and unloading at both ends by using T & P such as Tripod/cranes etc.(Considering max lead of 50KM)	TRP	40		
3	4060427	Transportation of Empty cable drum from site to site or from site to store any where in Union territory of Delhi.	TRP	40		
4	4060424	Transportation of various material like 40 mm dia Rod 12-15 mtrs long by 25 T trailor from store/any site in Delhi to site of work in Delhi including loading and unloading at both ends manually.(Considering max lead of 50KM)	TRP	5		
5	4060369	Digging of cable trench as per specification and drawings. Rate is inclusive of digging and backfilling. Measurement shall be as per actual depth excavated . For Dense Carpeted bituminous Road.	CUM	1575		
6	4060377	Digging of joint pit suitable for 33/66 KV cable joint box and covering the joint box with sand and providing protection as per BYPL/BRPL design. For Dense carpeted bituminous road.	Cum	600		
7	4060383	Digging of test pits of required size(not less than 1/2 Mtr. Wide at site for identification of cable route). Relevant volume shall be deducted from quantities of same item of cable digging For Dense carpeted bituminous road / CC Road	EA	50		
8	4060390	Grouting of cable mounting structure with cement concrete having ratio 1:3:6 including fixing with gantry structure. Badarpur, cement and stone ballast shall be supplied by contractor.Suitable for mounting 33/66 KV cable.	EA	4		
9	4060372	Removal of Malba including Loading / Unloading on own vehicle. The payment shall be restricted to the quantity of sand laid.	CUM	420		
10	4060388	Laying of underground cable in trench ,covering with RCC cable cover, covering with sand ,Sand cushion will be min 75mm below and 75mm above the cable, fixing of cable identification tags (9" X 4") at every 30 Mtrs, Laying of warning tape above 250mm of the docket, refilling the trench and ramming the surface & removal of malba if any, including watch and ward till charging of cable (This activity includes only labour jobs) for 66 KV three core cable Running Mtr	M	12000		
11	4060389	Extra for handling of 66KV Cable from cable drum. Note:If the Drum length is more than 250Mtr.	M	12000		

12	4060373	Providing and Laying Sand cushioning for cable route as per BRPL/BYPL specification and drawing.	CUM	420		
13	3005496	Crossing of roads by trench-less technology by laying of HDPE pipe excluding supply of pipe .Laying by HDD Machine Moling. Drilling and laying. 200mm dia.	M	4000		
14	4060398	Laying of HDPE pipe for crossing small Nallas in the cable route or in the existing trenches	M	800		
15	4060353	Providing and laying in position specified grade of reinforced cement concrete excluding the cost of shuttering,centring,finishing and reinforcement-All work upto plinth level : 1:2:4 (1cement :2 coarse sand :4 graded stone agg.20mm nominal size.)	CUM	50		
16	4060395	Charges for Hi pot test - Testing equipment to be provided by the contractor. For 66 KV cables	EA	8		
17	4060249	Fabrication of MS structure as well as galvanised for different equipment like isolator, C.T.'s, P.T.'s, CVT, LA's etc, cable supporting structure including supply of nuts and bolts, consumables , welding electrode, hacksaw blades etc. excluding supply of steel.	MT	3		
18	4060348	Erection of MS as well as galvanised structure for different equipment like isolator, C.T.'s, P.T.'s, CVT, LA's , ISO etc, cable supporting structure, 33kV/66 kV GI gantry structure , Tower Structure i/c consumables , welding electrode ,tack welding & hacksaw blades etc.	MT	3		
19	4060400	Painting of any M.S.Structure with one coat of Red oxide and two coats of AL.paint ISI marked including supply of paint by contractor.	KG	3000		
20	4060405	Digging of earth pit upto depth of 10 ft. inrocky/ semi rocky as per feasibility at site of embedding 600 x600mm earth plate with M.S Flate 50 x8 mm running the same through 3/4 " dia G.I. grouting pipe. Earth Plate to be covered by charcoal 200kg. And 100 Kg. Sodium chloride in the earth pit and refilling etc. NOTE: Charcoal, commonsalt, earth plate, G.I. Pipe, MS flat, Badarpur, Cement and bricks to be supplied by the contractor	EA	30		
21	4060409	Making of civil goomitties around GI earthpipe as per standard design of BSES. Supply of necessary bricks, cement, badarpur, sand, C1 cover of size 1'x1' and providing the same at the top of goomitties.	EA	30		
22	4060401	Charges for providing continous steel barricade 1.2 mtr high including cost of all material plant consumables transport and labour for shifting placing painting and regular maintenance.40% qty for selected portion	M	1200		
23	4060397	Mounting of 66KV,1x630sq.mm.XLPE cable with cable end box on the steel structure and fixing it with suitable wooden cleats (wooden cleats shall be supplied by contractor) i/c.its jumpering with the isolator as required.	EA	4		
24	4060000	Charges for carrying out Route survey and identification of underground utilities of various civic agencies before/ during execution of scheme involving cable laying work. Route length will be considered for payment. Route length will be specifically verified by DGM.	M	1500		

25	3005531	Crossing of roads by trench-less technology by laying of HDPE pipe excluding supply of pipe .Laying by Pneumatic Jack Hammer Road Cutting.laying . 200mm dia.	M	1600		
26	4060391	Supply and fixing of Cable Route/Joint Marker as per approved drawing.For 33/66 KV cables.	EA	50		
27	4060208	Laying of MS flat in the excavatd trench including risers, equipment earthing, overlapping of MS flat at the joints by twice of its width and welding of over lapping and cross joints including supply of electrodes, red oxide/bitumin compound , paint etcand Laying of GI earth strip for equipment earthing, along the wall, trench, cable trays etc including fabrication of supports/cleats and fixing with wall bolts, welding works, painting of earth strip and riser with red oxide paint/bitumin compound and final. For 50X6 sqmm	M	200		
28	4060423	Supply of warning tape per BSES Design specification (Width=150mm, Thickness=0.3u)	M	2000		
29	4060357	Providing and Fixing of Danger plates.	EA	6		
30	4060358	Providing and Fixing of number plates .	EA	6		
31	4060359	Providing and Fixing of Phase plates .	EA	6		
32	4060360	Providing and Fixing of circuit plates .	EA	6		
33		Electronic Ball marker at every 50 meter -passive	EA	45		
34		Electronic Ball marker at every at every joint - active	EA	40		
35		Coffin for Joint	EA	40		
36		Supply of LIU 48/96F fully loaded for OFC including Patch cord	EA	4		
37	4060418	Supply of Optical Fiber Cable	M	12000		
38	4060404	Laying of Optical Fiber cable	M	12000		
39	4060417	Supply of HDPE Duct-40mm	M	12000		
40	4060403	Laying of 40mm dia HDPE Duct in open trench	M	12000		
41		Making optical fibre end box(Splicing of 48F Optical Fiber Cable)	Nos	4		
42		Installation of LIU(48F) including Patch cord	EA	4		
		Total				
		GST 18%				
		Net Total				

1.B.SUPPLY BOQ

Scheme No: EW22GS4011

LILO OF 66KV TIKARI KALAN (MUNDKA) - NILOTHI GRID CKT 1 & 2 AT NEW PROPOSED CABLE LYING FOR 66KV
BAKKARWALA GRID

SR.NO.	Material Code	DESCRIPTION	UNIT	QTY	Rates inclusive of all other taxes without GST in Rs.	AMOUNT
1	2100217082	Supply of HDPE Pipes, PN 6 class PE 80 - 225mm dia	M	6400		
2	2100195673	Supply of RCC Slab (550X675) as per the specification of BRPL/BYPL	EA	4800		
		Total (B)				
		GST 18%				
		Net Total (B)				

GRAND SUMMARY OF THE QUOTED PRICE

Sr. No.	Scheme no.	SCHEME DESCRIPTION	Total price for supply F.O.R site inclusive all duties taxes	Total Price for Erection, Testing & Commissioning inclusive all Taxes(INR)	Grand Total(INR)
1	EW22GS4011	LILO OF 66KV TIKARI KALAN (MUNDKA) - NILOTHI GRID CKT 1 & 2 AT NEW PROPOSED CABLE LAYING FOR 66KV BAKKARWALA GRID.			
TOTAL Package Cost					
In words :					

We declare that the following are our quoted prices in INR for the entire project/schemes.

Date:

Bidder Name:

Place:

Bidders Address:

Name & Signature

Designation:

Common Seal:.....

Appendix- I**COMMERCIAL TERMS AND CONDITIONS – SUPPLY**

Sr. No.	Item Description	AS PER BRPL	BIDDER'S CONFIRMATION
1	Validity	120 days from the due date of submission or amended due date of submission	
2	Price basis	a) Firm , FOR Delhi store basis. Prices shall be inclusive of all taxes & duties, freight up to Delhi stores. b) Unloading at stores - in vendor's scope c) Transit insurance in Bidder scope	
3	Payment terms	a. 80% against R/A bills within 30 days against receipt of material at site. b. 10% pro-rata after installation/erection of equipment c. 10% pro-rata after completion of successful acceptance testing, commissioning and handing over of the entire Installation and duly certified by BRPL Project-in-charge.	
4	Completion time	15 th May 2025 from date of LOI/Order	
5	Defect Liability period	12 months from the date of Handing over of entire Installation.	
6	Liquidated damages	0.5% of total price for every week delay subject to maximum of 10% of total contract value	
7	Contract Performance Bank Guarantee	As mentioned above clause no.8 section III (A) page no. 29 of CPBG	

Note: RA is mandatory. The bids will be evaluate commercially based on the total all inclusive price. BRPL reserves the right to evaluate the bid in totality or partially. RA methodology will be informed separately to all the qualified bidders prior to RA.

Appendix-II**COMMERCIAL TERMS AND CONDITIONS – E/T/C**

SI No	Item Description	AS PER BRPL	BIDDER'S CONFIRMATION
1	Validity	120 days from the due date of submission or amended due date of submission	
2	Price basis	Firm. Prices shall be inclusive of all taxes & duties.	
3	Payment terms	a) 80% pro-rata of total installation value shall be payable against R/A bills payable within 30 days after installation/erection of material at site duly certified by Engineer in charge. b) 10% pro-rata of total installation value shall be payable against R/A bills payable within 30 days after testing & commissioning of material at site duly certified by Engineer in charge. c) 10% of contract value payable after completion of successful acceptance testing, commissioning and handing over of complete systems duly certified by Engineer in charge, submission of Electrical Inspector Clearance Certificate.	
4	Completion time	15 th May 2025 from date of LOI/Order	
5	Defect Liability period	12 months from the date of Handing over of entire Installation.	
6	Liquidated damages	0.5 % of the order value for each week or part there of delay until the actual date of completion up to a maximum deduction of 10% of total order value	
7	Contract Performance Bank Guarantee	As mentioned above clause no.6 section III(B) page no. 37 of CPBG	

Note: RA is mandatory. The bids will be evaluate commercially based on the total all inclusive price. BRPL reserves the right to evaluate the bid in totality or partially. RA methodology will be informed separately to all the qualified bidders prior to RA.



BSES Rajdhani Power Ltd.

ANNEXURE –I :BID FORM

To,

**Head of Department,
Contracts & Material Department,
BSES RAJDHANI Power Ltd
1st Floor, C Block
BSES Bhawan, Nehru Place
New Delhi 110019.**

Dear Sir,

- 1 We understand that BRPL is desirous of awarding the contract for..... (Name of the Work) work in its licensed distribution network area in Delhi.
- 2 Having examined the Tender Documents for the above named works, we the undersigned, offer to deliver the goods/services in full conformity with the Terms and Conditions, technical specifications & Scope of Work as may be determined in accordance with the terms and conditions of the contract. The quoted amounts for this work are in accordance with the Price Schedules attached herewith and are made part of this bid.
- 3 If our Bid is accepted, we undertake to deliver the entire goods/services as per delivery/ completion schedule mentioned in Section III from the date of award of order/letter of intent.
- 4 If our Bid is accepted, we will furnish a Contract Cum Performance Bank Guarantee (CPBG) for due performance of the Contract in accordance with the Terms and Conditions of the NIT.
- 5 We agree to abide by this Bid for a period of 180 days from the due date of bid submission and it shall remain binding upon us and may be accepted at any time before the expiration of that period.
- 6 We declare that we are aware of the provision of all Laws associated with the supply of equipment's/materials or Services and the prices have been quoted accordingly.
- 7 Unless and until Letter of Intent is issued, this Bid, together with your written acceptance thereof, shall constitute a binding contract between us.
- 8 We understand that BRPL is not bound to accept the lowest, or any bid BRPL may receive.
- 9 There is provision for Resolution of Disputes under this Contract, in accordance with the Laws and Jurisdiction of Contract.
- 10 We do hereby agree and shall abide the terms of tender documents/agreement, in full

Dated this..... day of..... 2025

Signature..... In the capacity of

.....duly authorized to sign for and on behalf of

(IN BLOCK CAPITALS).....

ANNEXURE – II: BIDDER’S DETAILS

S.No.	Item	Description
1	Company Name	
2	BRPL Vendor Code (If Registered)	
3	Area of Specialization	
4	Company Founded Year	
5	Type of Company	
6	Constitution(Company Registration number)	
7	Name of Director / Mobile Number	
8	Name of other main person / Mobile Number	
9	Vendor Address	
10	Vendor Contact no	
11	Vendor Email ID	-
12	No. of Manpower on payroll (Executive/Skilled/Semi-Skilled/Un-skilled)	-
13	No. of Contractual Manpower (Executive/Skilled/Semi-Skilled/Un-skilled)	-
14	Other Office / Factory Address	
15	ISO certification	
16	PAN	
17	PF/ESI	
18	Shop Establishment Certificate (If Applicable)	
19	Electrical License Detail (If Applicable)	
20	GST	
21	GST Registration Date	
22	SSI	
23	MSME Registration Number (If Applicable)	
24	Turn Over FY 2020-21 (Rs. Cr.)	
25	Turn Over FY 2021-22 (Rs. Cr.)	

S.No.	Item	Description
26	Turn Over FY 2022-23 (Rs. Cr.)	
27	Turn Over FY 2023-24 (Rs. Cr.)	
28	Profit after Tax FY 2020-21 (Rs. Cr.)	
29	Profit after Tax FY 2021-22 (Rs. Cr.)	
30	Profit after Tax FY 2022-23 (Rs. Cr.)	
31	Profit after Tax FY 2023-24 (Rs. Cr.)	
32	Networth (Rs Cr.)	
33	Bank Guarantee Limit (in Cr.)	
34	Over Draft/Cash Credit Limit (in Cr.)	
35	Present Order Booking (Rs Cr.)	
36	Order executed with Reliance ADA (Rs Cr.)	
37	Name & Detail of relative working in BRPL	
38	Main Customer	
39	Details of orders executed / Under Execution	Please submit the details in Attachment - A

ATTACHMENT – A

Reference List of Order Executed / under Execution by the Vendor (M/s)

A) Major Orders Executed

<u>SN</u>	<u>Name of Project</u>	<u>Client name & address</u>	<u>Client contact Detail</u> (Person name, e-mail ID, Mobile & landline number)	<u>Vend or's Scop e of Work</u>	<u>Date Of Award</u>	<u>Value of Work (Rs in Lakhs)</u>	<u>Completi on date as par Order</u>	<u>Actual Compl etion Date</u>	<u>LD / Penalty imposed, if any (Rs in Lakhs)</u>	<u>Litigatio n / Arbitrati on (Y/N) (If Yes, furnish details)</u>	<u>Rema rks</u>
1.											
2.											
3.											
4.											
5.											

B) Orders Under Execution

<u>SN</u>	<u>Name of Project</u>	<u>Client name & address</u>	<u>Client contact Detail</u> (Person name, e-mail ID, Mobile & landline number)	<u>Vend or's Scop e of Work</u>	<u>Date Of Award</u>	<u>Value of Work (Rs in Lakhs)</u>	<u>Completi on date as par Order</u>	<u>Actual Compl etion Date</u>	<u>LD / Penalty imposed, if any (Rs in Lakhs)</u>	<u>Litigatio n / Arbitrati on (Y/N) (If Yes, furnish details)</u>	<u>Rema rks</u>
1.											
2.											
3.											
4.											
5.											



BSES Rajdhani Power Ltd.

ANNEXURE – III :ACCEPTANCE FORM FOR PARTICIPATION IN REVERSE AUCTION EVENT

(To be signed and stamped by the bidder prior to participation in the auction event)

BRPL intends to use the reverse auction through SAP-SRM tool as an integral part of the entire tendering process. All the bidders who are found as techno commercially qualified based on the tender requirements shall be eligible to participate in the reverse auction event.

The following terms and conditions are deemed as accepted by the bidder on participation in the bid event:

1. BRPL shall provide the user id and password to the authorized representative of the bidder. (Authorization letter in lieu of the same be submitted along with the signed and stamped acceptance form)
2. BRPL will make every effort to make the bid process transparent. However, the award decision by BRPL would be final and binding on the supplier/Contractor.
3. The bidder agrees to non-disclosure of trade information regarding the purchase, identity of BRPL, bid process, bid technology, bid documentation and bid details.
4. The bidder is advised to understand the auto bid process to safeguard themselves against any possibility of non-participation in the auction event.
5. In case of bidding through internet medium, bidders are further advised to ensure availability of the entire infrastructure as required at their end to participate in the auction event. Inability to bid due to telephone line glitch, internet response issues, software or hardware hangs; power failure or any other reason shall not be the responsibility of BRPL.
6. In case of intranet medium, BRPL shall provide the infrastructure to bidders, further, BRPL has sole discretion to extend or restart the auction event in case of any glitches in infrastructure observed which has restricted the bidders to submit the bids to ensure fair & transparent competitive bidding. In case of an auction event is restarted, the best bid as already available in the system shall become the start price for the new auction.
7. In case the bidder fails to participate in the auction event due any reason whatsoever, it shall be presumed that the bidder has no further discounts to offer and the initial bid as submitted by the bidder as a part of the tender shall be considered as the bidder's final no regret offer. Any offline price bids received from a bidder in lieu of non-participation in the auction event shall be out rightly rejected by BRPL.
8. The bidder shall be prepared with competitive price quotes on the day of the bidding event.
9. The prices as quoted by the bidder during the auction event shall be inclusive of all the applicable taxes, duties and levies and shall be FOR at BRPL site.
10. The prices submitted by a bidder during the auction event shall be binding on the bidder. No further communication will be there.
11. No requests for time extension of the auction event shall be considered by BRPL.
12. The original price bids of the bidders shall be reduced on pro-data basis against each line item based on the final all-inclusive prices offered during conclusion of the auction event for arriving at contract amount.

For.....

Signature:

Name:

Designation:

ANNEXURE – IV: ENVIRONMENTAL, OCCUPATIONAL HEALTH & SAFETY CONDITIONS OF CONTRACT

1.0 General Requirements

- 1.1 The contractor shall ensure that safety of all the workers, materials, Installation and equipment's belonging to him or to others and working at the site is ensured through effective and practicable safety management systems.
- 1.2 The contractor shall be responsible for compliance to provisions of all safety requirements under various notices, acts, rules and relevant applicable legislations.
- 1.3 The contractors shall comply with all health & safety requirements as deemed necessary by BRPL from time to time.
- 1.4 Works shall be carried out by the contractor after taking necessary "Permit to work". Also the work shall not be carried out without use of Protective equipment's like shoes, safety belts, helmets etc. adhering to safety compliance.
- 1.5 All the equipment's being used shall be timely calibrated and a copy of the same shall be submitted to Safety Department within 4 weeks of the acceptance of contract and thereafter on every renewal.

2.0 EHS Policy

The contractor as per requirement of CEA Measures Relating to Safety and Electric Supply Regulations, 2010 shall follow the Environment, Health & Safety policy of BRPL. The contractor shall implement quality, health & safety management systems in accordance to BRPL EHS policy and ensure that intentions of such policy are met.

3.0 Health & Safety Plan

- 3.1 Within 4 weeks of the notification of acceptance of the tender, the contractor shall submit a detailed and comprehensive Contract specific health & safety plan incorporating HIRA (Hazard Identification & Risk Analysis) to BRPL. This plan shall necessarily include detailed policies, procedures, method statement for each activity to be performed and regulations which, when implemented, will ensure compliance of the contract provisions stated herewith.
- 3.2 The contractor shall submit health & safety plan for such activities required to be carried out under the awarded contract as deemed necessary by BRPL.
- 3.3 Health & safety plans, procedures, method statements, etc. developed & submitted by contractors shall be reviewed and approved by designated authorities of BRPL (Head Safety). First cut of the plan shall be submitted to Safety Department within 2 weeks of agreement of contract. After suggested rectification, the final plan shall be submitted to Head Safety not later than 4 weeks of the agreement of contract. A copy of the same shall be given to the engineer in charge also. The document shall carry the signatures of the authorized signatory (the person who has signed the agreement document of contract).
- 3.4 The health & safety plans, procedures, method statements, etc. shall not be changed without prior review and approval by designated authorities of BRPL.

4.0 OHS Organization & Responsibility

- 4.1 The contractor supervisor will play the role of safety supervisor. The safety supervisor shall hold a diploma degree from a recognized institute or university as per CEA Regulations, 2010. Also simultaneously contractor has to ensure their competency in safety or EHS with 40 hours training from reputed agency (like RLI/Allied Boston/ National Safety Council) or trainer, which should be verified earlier by BRPL safety department accordingly. The copy of training certificate shall be submitted to Safety Department within 4 weeks of agreement of contract. Time extension may be given in extraordinary situation subjected to submission of any

convincing document carrying valid proof of near future plan of the training.

- 4.2 The training certificate should not be more than one-year-old.
- 4.3 Apart from above, as an owner of the company the contractor & their other key persons are also responsible for safety compliance and related issues.

5.0 First Day at Work –Induction Training and Issuance of ID-Card

- 5.1 The contractor shall ensure that all his workers have undergone the safety induction and have been issued with a valid ID card prior to start work at BRPL site. The proof of the same shall be submitted to Safety Department within 4 weeks of agreement of contract.
- 5.2 All contractor workers shall undergo above as per the BRPL site specific procedure issued from time to time.
- 5.3 The contractor shall ensure that no worker is in any O&M activities until the valid ID card is issued and the same is available by each worker at site including that of sub-contractor(s).
- 5.4 In case any worker lost the ID card issued to him, the contractor shall ensure that such incidences are promptly reported to BRPL and duplicate or new ID card is issued immediately after completing formalities as deemed necessary by BRPL.

6.0 Provision of Safe Working Conditions

- 6.1 Proper barricading shall be created during height work, cable laying work, working on pole, etc. Dimensions of barricading while cable laying work- Height- 2 mtr, Length- 1.5 mtr. There shall not be any gap in between two barricades. LED Bacon light shall be placed at 1st and every 4th barricade. However, while working on pole during supply maintenance work there should be a barricading cone and caution tape . In narrow lanes, where proper barricading as per rules is not possible, use barricading as per the approval of respective safety circle head in writing and copy forwarded to safety and uploading in QMS.

6.2 PPE' Requirement

- 6.2.1 The contractor shall ensure all the required PPEs given in clause 6.2 and shall allow their workers to start work at site only after proper verification of adequacy of safety gears/PPE required for the specific job at site by the Safety personnel/Site Engineer of BRPL.

Contractor has to ensure the quantity and quality of PPEs during procurement and continuous usage of following PPE's by his staff.

S.NO.	NAME OF THE PPEs	LINEMAN / FITTER/SKILLED	HELPER/UNSKILLED	SUPERVISOR
1	SAFETY HELMET	✓	✓	✓
2	FULL BODY HARNESS (POSITIONING BELT)	✓	X	X
3	ELECTRICAL HAND GLOVES	✓	✓	X
4	SAFETY SHOES	✓	✓	✓
5	SAFETY GOGGLES	✓	✓	✓
6	REFLECTIVE	✓	✓	✓

	JACKET			
--	--------	--	--	--

6.2.2 Contractor has to ensure for proper procurement and distribution of required PPE's among their workers with receiving in attached format (Appendix-3) which will be verified by the safety department during inspection. The entire issuance format duly signed by individual worker and to be verified/ certified by Department Head and the same need to be submitted to Safety Department along with mentioned certificates within 4 weeks of agreement of contract. The sample of the PPE's being procured by the contractor shall be submitted and approved from the Safety Department beforehand.

6.2.3 The contractor has to provide 3 arc protection face shields in each zone (2 for complaint team and 1 for maintenance team) as per specifications mentioned in clause 6.2.5.6.

6.2.4 If any of the contractor staff found without PPEs, the said PPE's will be issued to them from BRPL store with immediate effect. And the 20% extra amount with procurement cost will be recovered from their next monthly bill cycle.

Note: PPEs shall strictly be as per the brand mentioned in clause 6.2.5

6.2.5 Technical Specification of the PPEs

6.2.5.1. Safety Shoes – With Composite / Fiber toes (CE approved / IS 15298) – Mandatory for all personnel working at BRPL O&M. The safety shoes shall meet the following features:

1. Electric Shock Resistant Sole
2. Impact Resistant
3. Scrap/Heat Resistant
4. Slip Resistant
5. Oil and Acid Resistant
6. Rubber PU Sole
7. Anti-puncture

Lead MAKE: BATA/HONEYWELL/KARAM

6.2.5.2 Safety Helmets: (IS 2925 - 1984 or DGMS) with chin strap – Mandatory for all personnel working at BRPL O&M. The specification of safety helmet shall be as given below:

V-GARD HDPE Yellow With 4 Point FasTrac Ratchet Suspension

Shell Material	UV stabilizedHDPE, Non vented
Suspension	<ul style="list-style-type: none"> • With 4 Point FasTrac Ratchet Suspension sewn headband • Textile straps made from polyester Suspension • point fixing: good positioning, ...stability, better air circulation due to ...limited contact areas with the head • Easy clean sweatband
Size	52-62 cm
Accessory slot	Standard 30 mm with removable HDPE dead plugs suitable to leak proof fitting
Approvals	ANSI/ IEC Z89.1 Class E (electrical)
Additional	Low temperature -10°C (acc. to GB2811), High temperature

	+50°C
Colours	Yellow
weight	360 g

Lead MAKE: 3M / KARAM / UFS

6.2.5.3 Full Body positioning Harness: (CE approved / IS 3521 / EN 361 / EN 355) – Shall be used while work is in progress at height more than 1.8 meter or where from a person may fall and get injured. The specification of the Full body harness shall be as given below:

Anchorage	Adjustable two chest attachment D-rings and A dorsal attachment D-ring
Adaptability	Adjustable shoulder and thigh straps
Convenience	Shoulder and thigh straps differentiated by a dual color scheme.
Ergonomics	Ideally. Positioned sit strap for extended comfort.
Size	Standard
weight	1200GMS
ENERGY ABSORBING FORKED LANYARDS :	
Spec.	44mm wide polyamide webbing.
Length	1.5 Meter

There should not be any metallic part in the full body harness.

Lead MAKE: KARAM /LIFEGEAR/UFS/HONEYWELL

6.2.5.4 Flex Chem Full View Safety Goggles – Shall be used to protect workers eyes from foreign materials and flying particles. Mandatory for all personnel working at BRPL O&M. Safety goggles shall meet the following feature:

1. Acetate lens for special applications requiring superior chemical resistance.
2. Industrial version of tough and popular first responder goggles.
3. Soft Flex low profile frosted frame for increased comfort.
4. Comfortable headband with length adjustment.
5. Indirect venting for comfortable, long lasting wear can be worn with safety helmets and over prescription spectacles.
6. Sight Gard + premium anti-fog coating (EN 166 "N") with good anti- scratch properties.

Technical Specification:

Weight	95g.
Lens thickness	1.0mm
Overall width	173mm
Overall length	90mm
Bridge	47.6mm
Lens base	5.5 curve
Lens size	86.1mm verticle, 174mm diagonal
Headband	Adjustable length at max.440mm(long enough to fit together with helmets)
Material & colors	
Lens	Acetate clear, coating, Sightgard + anti-fog according to EN 166 "N" & anti scratch.
Body	PVC smoke
Headband holder	Nylon
Headband	Adjustable grey elastic fixed on frame side parts
Marking / Approvals	
Standard number	EN 166
Frame marking	MSA EN 166 34-FT CE
Lens marking	2C-1.2 MSA 1 FT N CE
Filter class	2C (Ultra violet radiation with enhanced color recognition)
Scale number	1.2: luminous trasmittance-89%
Optical class	1 (best class, for permanent wear)
Mechanical resistance	F (low energy impact 45m/s) T (at extreme temperature -5 to +55 ^o C)
Resistance to	N(distorted vision due to lens fogging)
UV filter	99.9%
Ordering information	10145578-FlexiChem Sightgard + clear , 6x

Lead MAKE: MSA / UVEX/ UFS/3M/KARAM

6.2.5.5 Electrical Insulating Hand Gloves – Shall be used to prevent electric shock based upon the hazards/risks involved in a particular activity. Safety goggles shall meet the following features:

- Breakthrough manufacturing process for exception dry grip.
- Soft and flexible for enhanced tactility, high dexterity and wearer comfort.
- Ergonomic design featuring tapered fingers to reduce hand fatigue.
- Relaxed wrist for easy on/off.

	For LT work	For HT work
Length	360mm	360mm
Class	2	0
Thickness	3.6mm	1mm
Proof test voltage	20000	5000
Maximum use voltage	11000	1000
Tensile strength	>16mpa[Mega Pascal]	
Puncture resistance	>18N/mm [Newton per mili meter]	
Elongation at break	>600% [Stretching length]	
Tension set	<15%	

- It should be resistant to oil, acid, ultra violet rays and very low temperature.
- Each pair of glove should be marked with class, category, month & year of manufacturing, CE logo, batch no. and certified laboratory no.
- EN certified to electrical and thermal hazards,
- EN certified to thermal & electrical hazards to confirm EN 60-903,
- EN certified to mechanical hazard to EN-388
Lead MAKE: Honeywell / ANSELL/CATU

6.2.5.6 Arc Protection Face Shield

- a) ATPV value is 10 cal/cm²
- b) It shall have a slotted hard hat and chin guard
- c) Visible light transmission (VLT) shall be 70%
- d) It should have anti fog lens
- e) It should have a provision for replacement of lens and brackets.
- f) It should cover the complete face and the complete neck region.
- g) It must not hinder the work. Must be comfortable for the height jobs as well as in the ground.
- h) Carry bag for the kit.

Lead MAKE: Oberon/Honeywell

6.2.5.7 Certificates required for all PPEs:

1. Manufacturer Certificate
2. Test Certificate
3. Authorization of Dealership/Distribution ship

The copy of all the certificates shall be submitted to safety department within 4 weeks of agreement of contract.

7.0 Integrated Management System & Audits

7.1 The Contractor shall work in the framework of Integrated Management System (IMS) and shall

maintain documentation as prescribed in the IMS Manual of BRPL. IMS Manual can be obtained directly from site engineer/Division Head/Respective Head.

- 7.2 All contractors during their currency of contract shall strive to continuously improve and demonstrate strict compliance to ISO 9001, 14001 & 45001 standards of BRPL.
- 7.3 To verify compliance and to continually improve the management system, all contractors shall be subjected to both internal & external audits.

8.0 Medical Examination

- 8.1 The contractor shall arrange a medical examination of all his employees including his sub-contractor employees like lineman, ALM, supervisor, Fitter, welders, gas cutters, drivers and all the workers supposed to work at height (and any other trade specified deemed necessary by BRPL at the time of deployment then annually) before employing, after illness or injury, if it appears that the illness or injury might have affected his fitness and, thereafter, once in every year as per the provisions of applicable laws or as prescribed by BRPL with proper record.
- 8.2 Records of medical examination as described above shall be maintained at the contractor premises and a copy of the same shall be submitted to Safety Department within 4 weeks of agreement of contract.
- 8.3 No person about whom the Contractor knows or has reason to believe that he is a deaf or he has a defective vision or he has a tendency to giddiness shall be required or allowed to work in any O&M operation or other construction work which is likely to involve a risk of any accident either to the worker himself or to any other person.

9.0 Working at Height

- 9.1 The Contractor shall ensure that all works carried out at a height of 2 Meter or more shall only be started after obtaining a permit to work at height, which shall be issued as per the procedure of BRPL by authorized personnel.
- 9.2 The contractor shall ensure that all control measures mentioned and agreed through above work permit or as deemed necessary by BRPL are enforced and complied all the time during activities carried out at height.
- 9.3 Full body harness and ladder along with the required PPEs shall be used during height work.
- 9.4 Barricading cone and tape shall be used along with creation of proper safety zone.

10.0 Reporting of Near Miss/ Incidents / Dangerous Occurrences

- 10.1 In case of any incident/ accident occurs during the O&M activities undertaken by the Contractor thereby causing a dangerous occurrence or near miss or any minor or major or fatal injury to his employees due to any reason, whatsoever, it shall be sole responsibility of the Contractor to promptly inform the same to Department Head in prescribed form and also to all authorities envisaged under the applicable laws.

11.0 Suspension of Work

- 11.1 BRPL shall have the right at its sole discretion to suspend the work till compliance of safety norms, if in its opinion the work is being carried out in such a way that it may cause accidents and endanger the safety of the persons and / or property, and / or equipments.
- 11.2 In such cases, the contractor shall be informed in writing about the nature of hazards and possible injury /accident and he shall comply to remove all shortcomings promptly. Decision of BRPL shall be conclusive and binding on the Contractor in such aspects.
- 11.3 The contractor shall not be entitled to damages / compensation for suspending of work due to safety reasons and the period of such stoppage of work will not be taken as an extension of time for completion of the facilities as per the work order and will not be the ground for waiver of levy of liquidated damages.

11.4 The contractor shall follow and comply with all safety Rules of BRPL, relevant provisions of applicable laws pertaining to the safety of workmen, employees plant and equipment as may be prescribed from time to time without any demur, protest or contest or reservation. In case of any nonconformity between statutory requirement and safety rules of the BRPL referred above, the latter shall be binding on the contractor unless the statutory provisions are more stringent.

12.0 OHS Appreciation Policy

12.1 If the contractor observes all the safety rules and codes, statutory laws and rules during the period of the contract awarded by the BRPL and no accident occurs then BRPL may consider the performance of the contractor and safety score card will be prepared. The best contractor will be appreciated by suitable "SAFETY AWARD" as per scheme as may be announced separately from time to time.

13.0 Safety Motivational Scheme for Contractor Employee

13.1 All contractors must reward their employee monthly for best worker in term of complying safety norms. They should honour with a gift of Rs. 500/- (five Hundred) with commendation certificate to motivate others towards safety compliance. The record with photograph should kept with them & also to be submitted to BRPL safety department. Contractor may ask to BRPL safety people for their presence during awarding time.

13.2 All contractors have to observe safety day/ week on 4th March to 10th march every year with proper planning and record to create safety awareness inside their organization. A detailed report of observing the same to be forwarded to safety department every year.

14.0 Guidelines for Penalty Policy Implementation

14.1 Total penalty shall be calculated by multiplying the number of safety violations and the penalty amount specified for such violations in **Appendix - 1. (Example – If at first offence persons are found working without safety helmet at 3 locations, the penalty would be $3 \times 2000 = \text{Rs.6000/-}$)**

14.2 The amount of penalty can be increased or decreased based upon the seriousness of safety violations. The decision of recommending authority shall be final one.

14.3 Recommending authority shall send his factual observations to Department Head and Safety Head who in turn shall either reject or approve it. If approved, he shall send it to Finance & Accounts for execution. Finance Accounts shall execute the penalty and confirm the same & shall send it back to Department Head and Safety Head.

14.4 Recommending Authority means the Department Head, HODs, Site Safety officer / Supervisor, representatives from OHS and other personnel authorized jointly by O&M.

14.5 Penalties will be imposed for delay in submission of EHS related requirements/documents mentioned in the contract. Once the contract is accepted, the requirements as mentioned in **Appendix- 2 to be submitted within 4 weeks.**

14.5 Safety Head may impose penalty for serious violations directly.

14.6 All penalties shall be imposed directly on the concerned contractors. No penalty shall be imposed on individuals.

15.0 Guidelines for Safety Appreciation Policy Implementation

15.1 Recommending Authority shall write comments of his Appreciation in case he observes that there is no any safety violations.

15.2 Recommending Authority shall send his Safety Appreciation to Safety Head who in turn shall either approve or reject it and shall send it to Site Safety Officer for keeping in records.

BSES Rajdhani Power Ltd.

- 15.3 Management will appreciate the Safe Contractors for their best performance towards safety norms based upon number of safety appreciation notes.
- 15.4 Every year best Safe Contractor shall be suitably awarded. The contractor shall be selected based upon the maximum numbers of approved safety appreciation notes.
- 15.5 Any contractor who has received any penalty for a particular year shall not be entitled for Safe Contractor's Award irrespective of number of safety appreciation notes he has received.
- 15.6 Site Safety Officer will maintain the contractor wise record of penalty & safety appreciation notes and declare the results latest by 28th February of every year for the performance of previous year.
- 15.7 BRPL Management shall present a Trophy with commendation certificate of safety excellence every year on the occasion of 4th to 10th March (National Safety Day) to the contractor, who qualified the safety standard criteria.

Appendix – 1**Penalty Policy on Safety Violation**

	Type of Offense	Penalty Detail	Execution Channel
A	Not Wearing Safety Helmets Safety shoes/ Safety Goggles / Electrical insulating hand gloves/ reflective jacket/Not using electrically safe tools and equipments. (Poor quality or damaged item means noncompliance)	# First Offence - Warning Note & Rs.2000/- # Second Offence - Warning Note & Fine of Rs.5000/- # Third Offence- Note of recommendation of the concerned workmen/ supervisors for removal from deployment with BRPL& Fine of Rs.15000/-	Recommendation by OHS- Representative/Department Head Approval by Safety Head Deduction by Finance & Account
B	Not wearing Full Body Harness/fall arresters while working at a height more than 1.8 meter or where from a person may fall. Not using Safety Net to arrest falling objects and personnel. Not using Arc Protection Face Shield Not using barricading cone and tape. (Poor quality or damaged item means noncompliance)	# First Offence -Warning Note & Fine of Rs.5000/- # Second Offence - Warning Note for dismissal and a Fine of Rs.10000/- # Third Offense - -Action for the concerned Workmen/ supervisor for removal from deployment with BRPLand a fine of Rs.25000/-	Recommendation by OHS- Representative/Department Head Approval by Safety Head Deduction by Finance & Account
C	Any other unsafe work practices or condition which is considered having potential for fatality or injury to personnel.	# First Offence - Warning Note & Fine of Rs.10000/- # Second Offence - Action for the concerned workmen/ supervisors for removal from deployment with BRPL and fine of Rs.20000/-.	Recommendation by OHS- Representative/Department Head Approval by Safety Head Deduction by Finance & Account

Notes:

Refer clause No. 14 for penalty policy implementation guidelines

If there are 03 violations by an individual employee, his removal from deployment with BRPL # If there are 10 violations in one quarter, will be recommended for termination of contract order.

Appendix – 2

Penalty Policy on non- submission of EHS related requirements

Following EHS related requirements to be submitted within 4 weeks of agreement of contract		
Requirement	Penalty Detail	Execution Channel
1. Contract specific health & safety plan and HIRA (Hazard Identification & Risk Analysis)		
2. Safety supervisor training records on EHS (40 hrs training)		
3. Submission of sample of PPE's in EHS department for approval (if procured by the contractor)	Delay of 15 days- Warning Note & Consolidated Fine of Rs.5000/- on non-submission of proof of any of these mentioned 8 types of documents	
4. Bills/challan of PPE's along with test certificates (if procured by the contractor)	On every subsequent delay of 15 days- Warning Note & Consolidated Fine of Rs. 10,000/- on non-submission of proof of any of these mentioned 8 types of documents	Recommendation by OHS- Representative
5. PPE's receipt by worker (as per Appendix-3)		Approval by Safety Head Deduction by Finance & Account
6. Medical examination record of workers		
7. ID card of workers		
8. Calibration Certificates of equipment's		



BSES Rajdhani Power Ltd.

FORMAT – 4.1

EMD BANK GUARANTEE

(To be issued in a Non Judicial Stamp Paper of Rs.100/-purchased in the name of the bank)
Whereas [name of the Bidder] (herein after called the "Bidder") has submitted its bid dated[date of submission of bid] for the supply/services of [name and/or description of the goods/sevices] (here after called the "Bid"). KNOW ALL PEOPLE by these presents that WE [name of bank] at [Branch Name and address],having our registered office at[address of the registered office of the bank](herein after called the "Bank"),are bound unto BSES RAJDHANI Power Ltd., with its Corporate Office at BSES Bhawan, Nehru Place, New Delhi - 110019 ,(herein after called —the "Purchaser")in the sum of (Rupees only) for which payment well and truly to be made to the said Purchaser, the Bank binds itself, its successors, and assigns by these presents. Sealed with the Common Seal of the said Bank this ____ day of ____ 2024. The Conditions of this obligation are:

1. If the Bidder withdraws its Bid during the period of bid validity specified by the Bidder on the Bid Form;

or

2. If the Bidder, having been notified of the acceptance of its Bid by the Purchaser during the period of bid validity:
 - (a) Fails or refuses to execute the contract form, if required: or
 - (b) Fails or refuses to furnish the performance security, In accordance with the instructions to Bidders/Terms and Conditions.

We undertake to pay to the Purchaser up to the above amount upon receipt of its first written demand, without the Purchaser having to substantiate its demand, provided that is its demand the purchaser will note that amount claimed by it is due to it, owing to the occurrence of one or both of the two condition(s), specifying the occurred condition or condition(s). This guarantee will remain in force up to and including 180 days after the due date of submission bid, and any demand in respect thereof should reach the Bank not later than the above date.

(Stamp & signature of the bank)

Signature of the witness(s)

FORMAT – 4.2**PROFORMA OF CONTRACT CUM PERFORMANCE BANK GUARANTEE****(TO BE ISSUED ON RS 100/- STAMP PAPER)**

This Guarantee made at _____ this [____] day of [____] 2025

1. WHEREAS **M/s BSES Rajdhani Power Limited**, a Company incorporated under the provisions of Companies Act, 1956 having its Registered Office at **BSES Bhawan, Nehru Place, New Delhi - 110019**, India hereinafter referred to as the “Company”, (which expression shall unless repugnant to the context or meaning thereof include its successors, administrators, executors and assigns).
2. AND WHEREAS the Company has entered into a contract for _____ (Please specify the nature of contract here) vide Contract No. _____ dated _____ (hereinafter referred to as the “Contract”) with M/s. _____, (hereinafter referred to as “Contractor”, which expression shall unless repugnant to the context or meaning thereof be deemed to mean and include each of their respective successors and assigns) for providing services on the terms and conditions as more particularly detailed therein.
3. AND WHEREAS as per clause ____ of General Conditions of Contract, the Contractor is obliged to provide to the Company an unconditional bank guarantee for an amount equivalent to ten percent (10%) of the total Contract Value for the timely completion and faithful and successful execution of the Contract from [_____] pl. specify the name of Bank) having its head/registered office at [_____] through its branch in _____ (pl. specify the name of Branch through which B.G is issued) hereinafter referred to as “the Bank”, (which expression shall unless it be repugnant to the context or meaning thereof be deemed to include its successors and permitted assigns).
4. NOW THEREFORE, in consideration inter alia of the Company granting the Contractor the Contract, the Bank hereby unconditionally and irrevocably guarantees and undertakes, on a written demand, to immediately pay to the Company any amount so demanded (by way of one or more claims) not exceeding in the aggregate [Rs.].....(in words) without any demur, reservation, contest or protest and/or without reference to the Contractor and without the Company needing to provide or show to the Bank ,grounds or reasons or give any justification for such demand for the sum/s demanded.
5. The decision of the Company to invoke this Guarantee and as to whether the Contractor has not performed its obligations under the Contract shall be binding on the Bank. The Bank acknowledges that any such demand by the Company of the amounts payable by the Bank to the Company shall be final, binding and conclusive evidence in respect of the amounts payable by the Supplier to the Owner. Any such demand made by the Owner on the Bank shall be conclusive and binding, notwithstanding any difference between the Owner and the Contractor or any dispute raised, invoked, threatened or pending before any court, tribunal, arbitrator or any other authority.
6. The Bank also agrees that the Company at its option shall be entitled to enforce this Guarantee against the Bank as a principal debtor without proceeding against the Contractor notwithstanding any other security or other guarantee that the Company may have in relation to the Contractor's liabilities.
7. The Bank hereby waives the necessity for the Company first demanding the aforesaid amounts or any part thereof from the Contractor before making payment to the Company and further also waives any right the Bank may have of first requiring the Company to use its legal remedies against the Contractor, before presenting any written demand to the Bank for payment under this Guarantee.

8. The Bank's obligations under this Guarantee shall not be reduced by reason of any partial performance of the Contract. The Bank's obligations shall not be reduced by any failure by the Company to timely pay or perform any of its obligations under the Contract.
9. The Bank further unconditionally and unequivocally agrees with the Company that the Company shall be at liberty, without the Bank's consent and without affecting in any manner its rights and the Bank's obligation under this Guarantee, from time to time, to:
 - (i) Vary and/or modify any of the terms and conditions of the Contract;
 - (ii) Forebear or enforce any of the rights exercisable by the Company against the Contractor under the terms and conditions of the Contract; or
 - (iii) Extend and/or postpone the time for performance of the obligations of the Contractor under the Contract;

and the Bank shall not be relieved from its liability by reason of any such act or omission on the part of the Company or any indulgence shown by the Company to the Contractor or any other reason whatsoever which under the law relating to sureties would, but for this provision, have the effect of relieving the Bank of its obligations under this Guarantee.

10. This Guarantee shall be a continuing bank guarantee and shall not be discharged by any change in the constitution or composition of the Contractor, and this Guarantee shall not be affected or discharged by the liquidation, winding-up, bankruptcy, reorganization, dissolution or insolvency of the Contractor or any of them or any other circumstances whatsoever.
11. This Guarantee shall be in addition to and not in substitution or in derogation of any other security held by the Company to secure the performance of the obligations of the Contractor under the Contract.
12. NOTWITHSTANDING anything herein above contained, the liability of the BANK under this Guarantee shall be restricted to _____ (insert an amount equal to ten percent (10%) of the Contract Value) and this Guarantee shall be valid and enforceable and expire on _____ (pl. specify date) or unless a suit or action to enforce a claim under this Guarantee is filed against the Bank on or before the date of expiry.
13. On termination of this Guarantee, all rights under the said Guarantee shall be forfeited and the Bank shall be relieved and discharged from all liabilities hereunder.
14. The Bank undertakes not to revoke this Guarantee during its validity except with the prior written consent of the Company and agrees that any change in the constitution of the Bank or the Contractor shall not discharge our liability hereunder.
15. Company may assign this Guarantee to any Person or body whether natural, incorporated or otherwise under intimation to the Bank. The Bank shall be discharged of its obligations hereunder by performance in accordance with the terms hereof to such assignee without verifying the validity / legality / enforceability of the assignment.
16. This Guarantee shall be governed by the laws of India. Any suit, action, or other proceeding arising out of, connected with, or related to this Guarantee or the subject matter hereof shall be subject to the exclusive jurisdiction of the courts of Delhi, India.
Dated this day of 2025 at

(Signature)

.....



BSES Rajdhani Power Ltd.

(Name)

.....

(Designation with Bank Stamp)

Attorney as per

Power of Attorney No.....

Date.....

Beneficiary's bank detail with IFSC Code:

Beneficiary Name	: BSES Rajdhani Power Limited
Bank Name	: State Bank of India
A/c No.	: 40214783615
IFSC Code	: SBIN0009601

Vendor has to fill this form & submit along with the PERFORMANCE BANK GUARANTEE

1. Bank Email ID-----Bank Phone No-----

2. Where to Dispatched the BG -Local Address of bank -----

3. Where to Dispatched the BG Head Office Address -----

FORMAT – 4.3

NON-DISCLOSURE AGREEMENT

THIS NON-DISCLOSURE AGREEMENT ("Agreement") is made and entered into at Delhi on the _____ day of _____, 2025

By And Between

M/s BSES Rajdhani Power Limited, a company registered under the Companies Act, 1956 and having its registered office at **BSES Bhawan, Nehru Place, New Delhi - 110019** (hereinafter referred to as the "Disclosing Party" which expression shall unless repugnant to the meaning and context mean and include its successors and permitted assigns) of the FIRST PART

And

_____, a company incorporated under the Companies Act, 1956 and having its registered office at _____, (hereinafter referred to as the "Receiving Party" which expression shall unless repugnant to the meaning and context mean and include its successors and permitted assigns) of the OTHER PART

Disclosing Party and Receiving Party are hereinafter individually referred to as the "Party" and collectively as the "Parties".

WHEREAS the Disclosing Party is in discussions with the Receiving Party for Security Management Services ("Project") and the Disclosing Party may in conjunction with the aforesaid disclose to the Receiving Party information relating to their businesses which is confidential and sensitive in nature and the Receiving Party is willing to undertake to restrict the use and further disclosure of the information in accordance with the terms and conditions set out herein:

1. The "Receiving Party" acknowledges and confirms the confidential and sensitive nature of all information, documents and material relating to Persons and entities which may be accused of or related to the theft of electricity which is a penal offense under the provisions of the electricity act 2003As well as the various data and tools which may be available by way of documents as well as other modes of proof("Project") (i) that may be disclosed or made available to the Receiving Party by the Disclosing Party or its employees/ representatives/ advisors/ consultants; (ii)Receiving Party may gain or gather from any source; (iii) Receiving Party may process or arrive at during the course of the Project; (iv) Receiving Party may have come across during its discussions with any person in the course of the Project; and (v) all negotiations and discussions between the Parties relating to the Project (all the information referred to above is hereinafter referred to as the "Confidential Information").
2. Confidential Information is understood to include but is not limited to information made available in written, machine recognizable, graphic or sample form including, without limitation, drawings, photographs, models, design or performance specifications, its analysis, compilations, studies, notes and all other information and data disclosed orally or visually which has been developed / is exclusive to the Disclosing Party and includes information provided in various meetings.

Provided, however, that Confidential Information shall not include information which (a) is, or becomes, publicly known, otherwise than through a wrongful act of the Receiving Party or its representatives; (b) is in the possession of the Receiving Party prior to receipt from the Disclosing Party or its representatives without an obligation of confidentiality; (c) is independently developed by the Receiving Party, provided that it was not derived from the Confidential Information; (d) is furnished to others by the Disclosing Party without restrictions, similar to those herein on the rights of such others to use or disclose; or (e) is approved in writing by the Disclosing Party for disclosure.

3. The Receiving Party shall not disclose the Confidential Information to any other person save

and except with the express consent in writing given by the Disclosing Party. The Receiving Party, however, may disclose such part of the Confidential Information where (i) such disclosure is in response to a valid order of a court or any other governmental body having jurisdiction over this Agreement or (ii) such disclosure is otherwise required by law, provided that Receiving Party has given prior written notice to the Disclosing Party forthwith it came to learn about such disclosure requirement or the demand for such for disclosure and made all reasonable efforts to protect the Confidential Information in connection with such disclosure.

4. The Receiving Party shall with reference to the Confidential Information take all actions as may be necessary to (i) maintain the confidentiality thereof; (ii) limit its use of such Confidential Information solely for the purpose of the Project; (iii) avoid disclosure even to any of its employees that are not associated with the Project; (iv) avoid any dissemination or publication by any of its employees/ representatives associated with the Project; (v) avoid writing about sensitive information which is disclosed verbally and is sensitive to the operations; and (vi) safeguard the Confidential Information from being accessed by any unauthorized person. Such actions shall include but not be limited to obtaining appropriate non-disclosure undertakings from its employees directly or indirectly engaged in the Project.
5. The Receiving Party hereby agrees to indemnify and hold harmless the Disclosing Party and its directors and employees from and against any damage, loss, cost or liability (including all expenses and costs of enforcing rights under the Agreement) arising out of or resulting from (i) any use or disclosure by the Receiving Party of Confidential Information in violation of the Agreement; (ii) any leakage of the Confidential Information at the end of the Receiving Party or its employees/ representatives; and (iii) breach or violation of any of the other covenants herein.
6. The Receiving Party will, promptly upon the request of the Disclosing Party, deliver to the Disclosing Party, the documents comprising the Confidential Information or any part thereof and will destroy any copies, notes, or extracts thereof, without retaining any copy thereof, except that any portion of the Confidential Information that consists of analysis and any written Confidential Information not so requested and returned, shall be retained and kept subject to the terms of this Agreement, or upon the Disclosing Party's request destroyed (such destruction to be confirmed in writing).
7. The term of this Agreement is 3 years from the date of execution of this Agreement. However, the obligation to maintain confidentiality of the Disclosing Party's information shall survive the termination of this Agreement. Any violation of this agreement may lead to termination of all the relations with the Receiving party and black listing/ debarring of the Agency for future engagements.
8. This Agreement shall be governed by the laws of India. Any dispute, difference or claim related to or arising under, out of or in connection with this Agreement shall be resolved subject to the jurisdiction of Delhi Courts.

For the Disclosing Party

Authorized Signatory

Name:

Designation:

For the Receiving party

Authorized Signatory

Name:

Designation:



BSES Rajdhani Power Ltd.

FORMAT – 4.4

NO DEVIATION DECLARATION

NO DEVIATION –A (Technical)

NIT NO & DATE:

DUE DATE OF TENDER:

We hereby accept all terms and conditions of the technical scope of work as mandated in the tender documents subject to the following deviations as mentioned against the applicable technical qualifying requirement:

S.NO.	SL.NO OF TECHNICAL SPECIFICATION/SCOPE OF WORK	DEVIATIONS, IF ANY

SIGNATURE & SEAL OF BIDDER

NAME OF BIDDER

Note-The above template is indicative only, May vary depending on the nature of procurement/value.

NO DEVIATION –B(Commercial)

NIT NO & DATE:

DUE DATE OF TENDER:

We hereby accept all terms and conditions of the commercial requirement as mandated in tender document subject to the following deviations as mentioned against the applicable commercial qualifying requirement:

S.NO.	S. NO OF COMMERCIAL REQUIREMENTS	DEVIATIONS, IF ANY

SIGNATURE & SEAL OF BIDDER

NAME OF BIDDER

Note:-It is important to explicitly include all such terms and conditions which are considered absolutely necessary to be accepted by bidder without any deviation. Tender document shall have a stipulation that deviation to such criteria shall make the bid liable for rejection.

FORMAT – 4.5**BIDDER'S COMMUNICATION DETAILS****Bidder should furnish the below details for future communication: -**

<u>GENERAL INFORMATION</u>	
NAME OF Company	
POSTAL ADDRESS	

FOR TECHNICAL QUERY:		
CONTACT PERSON & DESIGNATION	NAME	DESIGNATION
E-MAIL	MOBILE NO	TELEPHONE NO

FOR COMMERCIAL QUERY:		
CONTACT PERSON & DESIGNATION	NAME	DESIGNATION
E-MAIL	MOBILE NO	TELEPHONE NO

Note: No communication shall be entertained from any other email id, except as mentioned above. Bidder needs to inform the company if any changes in the email id on their letter head duly signed by the authorized signatory.

SECTION – VIII: TECHNICAL SPECIFICATION

BSES

BSES



TECHNICAL SPECIFICATION

FOR

LAYING OF 66 kV / 33 kV / 11 kV / 1.1 KV GRADE
PVC / XLPE CABLES

Specification no: GN101-03-SP-06-03

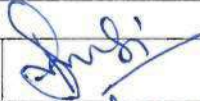
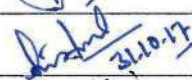
BSES RAJDHANI POWER LTD

Prepared by	Pronab Bairagi		Rev : 03
Reviewed by	Amit Tomar	 31.10.17	Date : 31.10.2017
Approved by	Vijay Panpalia		Pages : 44

Registered Office: BSES Bhavan, Nehru Place, Delhi - 110019

Index

General Specification	3
1.0.0 Codes & standards	3
2.0.0 Design Guidelines & Parameters for Cable laying.....	3
3.0.0 General Guidelines for Laying Cables.....	7
4.0.0 Testing	14
5.0.0 Progress Reporting	15
6.0.0 Drawing, Data & manuals.....	15
7.0.0 Deviations.....	16
Annexure # 1 – DEVIATION REPORT FORMAT.....	16
Annexure # 2 – DC HIGH VOLTAGE TEST	16
Annexure # 3 – CABLE TRENCH DETAILS	17
Annexure # 4 – STANDARD ROAD PROFILE	18
Annexure # 5 – ROAD RESTORATION SECTIONAL DRAWINGS.....	20
Annexure # 6 – DRAWINGS (CABLE TRENCH AND RCC CABLE COVER).....	23
Annexure # 7 – BARRICADING AND SAFETY.....	38
Annexure # 8 – ROUTE MARKER AND BARRICADING DRAWING.....	38
Annexure # 9- NOTE FOR HDPE PIPE DIAMETER IN CABLE LAYING.....	43

General Specification**1.0 Codes & standards**

Materials, equipment and methods used in the Laying of 11/33/66KV Cable shall conform to the latest edition of following –

S. No.	Reference No.	Name of Standard
1		Indian Electricity Rules, 1956
2		Indian Electricity Act, 1910
3		Indian Electricity Supply Act, 1948
4		Electricity Laws Act, 1991
5		National Electrical Code (Indian standards Institution)
6	IS 1255	Code of practice for installation and maintenance of Power Cable upto and Including 33KV rating.
7	IS 1554	PVC Insulated Electrical Cables upto 11KV
8	IS 2274	Code of Practice for electrical wiring installation – system voltage exceeding 650V
9	IS 7098 Part II	Crosslinked Polyethylene Insulated PVC sheathed cables for working voltages from 3.3KV upto and including 33KV
10	IS 7098 Part III	Crosslinked Polyethylene Insulated PVC sheathed cables for working voltages from 66KV upto and including 220KV
11	IS 5820	Specification of precast concrete Cable cover.

2.0 Design guidelines and Parameter for cable laying-

S. No.	Parameter	Details
2.1	Selection of Cable Route	<p>The cable route selection shall be done by the concerned supervising engineer by first conducting route survey and selecting a route along with contractor keeping followings in mind:</p> <ul style="list-style-type: none">-The side of road which presents the least obstacles and the fewest roadways crossings.-The future consumers and existing cables in the route may influence the cable route.-Railway, road crossings, MCD and other government agencies may also influence in selection of cable route.-Plans for future building projects should be considered.-The route shall be as far as possible away from parallel running gas, water pipes and telephone/telecommunication cables.
2.2	Site Preparation	<ul style="list-style-type: none">a) Barricading:<ul style="list-style-type: none">• The identified cable route shall be barricaded continually before excavation.• Barricading shall be as drawing laid• Open Trench method shall be adopted as far as possible for trench preparation.b) Excavated Earth:

		<ul style="list-style-type: none"> • The excavated earth shall be so stored at site, that it shall not cause trouble to running traffic • All excavated earth shall be stored within the barricaded area. • <p>c) Full height fence, barriers, barricades etc. shall be erected around the site in order to prevent the working area from the risk of accidents due to speedy vehicular movement. Same the way barricades protect the road users from the danger due to construction equipment and temporary structures.</p> <p>d) The structure dimensions of the barricades , material and composition, its colour scheme, BSES logo and details shall be in accordance with specification and drawing laid down in the tender documents.</p> <p>e) All the barricades shall be erected as per the design requirements of employer, numbered painted and maintained in good condition and also barricade in charge maintain a barricade register at site.</p> <p>f) All barricades shall be conspicuously seen in the dark/night time by the road users so that no vehicle hits the barricades. Conspicuity shall be ensured by affixing retro reflective strips of required size and shape at appropriate angle at bottom and middle portion of the barricades at a minimum gap of 1000 mm. In addition minimum one red light /red blinker and red beacon light should be placed at the top of each barricade.</p> <p>g) PPP to be provided by vendor to all workers and engineers.</p> <p>h) Also refer Annexure- 7: Barricading and Safety</p>
2.3	Clearance	<p>The desired minimum clearances are as follows –</p> <ul style="list-style-type: none"> - Power cable to power cable – A minimum clearance equal to diameter shall be maintained. Trench drawings shall be referred to for guidance. - Power Cable to control cables – 0.2 M - Power cable to communication cable – 0.3M - Power cable to gas/water main – 0.3 M
2.4	Depth of Cable Laying	<p>The desired minimum depth of laying from ground surface to the top of cable shall be:</p> <p>650 / 1100V grade XLPE Cables – 75 cm 6.35 / 11KV grade XLPE Cables – 90 cm Low voltage and Control cable - 75 cm 19 / 33KV grade XLPE Cables - 1.2 M 38 / 66KV grade XLPE Cables - 1.5 M Cables at Road crossing - 1.0 M (min.) Cables at railways level crossings (measured from bottom of sleepers to the top of Pipe) - 1.0 M (min.)</p> <p>Whenever there is any obstacle at the laying depth, the cable should be lowered/ raised to cross the obstacle. However variation in the depth is to be approved by BSES. The Contractor shall provide the same in deviation report.</p>
2.5	Width of Cable	<p>The width and depth of Cable Trenches shall depend upon number of</p>

	trenches	circuits and Voltage Grade. Annexure # 3 and drawings of this specification shall be followed.
2.6	Bending Radius of Cables	<p>While pulling of the Cable from the drum or during laying following minimum bending radius shall be maintained so that the cable, in particular the insulation does not get damaged –</p> <p>A) Single Core Cables (PVC & XLPE) Upto 1.1KV grade – 15 X D Above 11KV grade - 20 X D</p> <p>B) Multi Core Cables (PVC & XLPE) Upto 1.1KV grade - 12 X D Above 1.1KV grade – 15 X D</p> <p>Where 'D' is overall diameter of the cable.</p>
2.7	Maximum permissible Tensile Strength for Cables	<p>For cables pulled with Stocking PVC and XLPE SWA Armoured cables $P = 30 \times D$ PVC and XLPE AWA Armoured cables $P = 20 \times D$ Where P= pulling force in Kgrm, D= Diameter of Cable in mm</p> <p>For Cables pulled by Cable eyes Aluminium conductor – $30 \text{ N/mm}^2 = 3 \text{ Kg/sq. mm}$ Copper conductors - $50 \text{ N/mm}^2 = 5 \text{ Kg/sq. mm}$</p> <p>Permissible force is calculated by multiplying the above values by cross sectional area (CSA) of conductor of each core and then number of cores.</p>
2.8	Methods of Laying	<p>a) Cables shall be laid in direct in ground, in trenches excavated therein and shall be protected with covers as given in the drawing. Cables shall also be drawn into pipes of ducts or laid in the formed trenches or troughs or on racks or supported in trays or cleats as required by the site exigencies. Where the cables are laid in the formed trenches, the installation shall include removal and replacement of the trench covers and the provision of temporary protective covers on the trenches where they cross the access ways.</p> <p>b) HDPE (PN6,PE80) or RCC ducts shall be used where cable cross roads and railways tracks. Spare ducts for future extensions should be provided. Spare duct should be sealed off. Buried ducts or ducting blocks shall project into footpath or upto the edge of road, where there is no footpath, to permit smooth entry of cable without undue bending. The diameter of the cable conduit or pipe or duct should be at least 1.5 times the outer diameter of the cable. Angular alignment of the duct across road crossings shall be predetermined to maintain safe bending radius when direction of cable trench changes before or after the road.</p> <p>c) The contractor shall lay cable by Horizontal direct drilling (HDD) in main roads and highway with heavy traffic, passage to public property where excavation is not possible. Contractor shall take approval for laying of cable by means of HDD wherever required from the supervising engineer. The cable laid by HDD shall be</p>

		<p>minimized so that it doesn't exceed by 12% of total route length. This is to avoid De-rating of Cables.</p> <p>d) Unless approved by BSES, the contractor shall lay the cables, direct in ground, in single layer. The cables shall be laid with the pre-determined and approved cable route.</p> <p>e) Spacing shall be maintained uniformly between the cables all along the length including the bends, as approved by BSES. To maintain the spacing, suitable non-metallic formers shall be placed uniformly with spacing not exceeding 5 meters. Every bend shall have at least one spacer.</p> <p>f) 75 mm of the sand bed shall be placed at the bottom of cable trench.</p> <p>g) After the cables have been laid the trench shall be filled with the sand and shall be well rammed to a level not less than 75 mm above the top of the cables all throughout the route.</p> <p>h) To protect the cables against external mechanical damage, which may be caused by other agencies, the cable shall be protected by suitable cover. (for drawing of RCC cable cover refer annexure VI).</p> <p>i) The type of the covers shall be as under - 1.1KV Cables – Single layer of brick thickness not less than 75 mm (3 inch) - 11KV Cables – sand stone of thickness not less than 75mm (3 inch). - 33KV Cables shall be protected by reinforced concrete cover of width 300 mm as per attached drawing with thickness not less than 50mm. - 66KV Cables shall be protected by reinforced concrete cover as per attached drawing with thickness not less than 50mm.</p> <p>The RCC cable cover shall be embossed as "BSES EHV CABLE".</p> <p>j) Back fill to be filled up to 75mm and the warning tape shall be installed continuously. The tape shall be yellow in colour with Black / Red lettering of minimum 20mm height. The approved warning message shall be written in English and Hindi/ local language. The minimum thickness and width of the tape should be 300 microns and 150 mm respectively.</p> <p>k) The trench shall be filled-up by loose soft soil (300mm) and Excavated soil as indicated in drawings.</p>
<p>2.9</p>	<p>Cable over</p>	<p>On Bridges the cables are generally supported on wooden cleats and</p>

	Bridges	clamped on steel supports at regular intervals. The cables laid on bridges shall be provided with Sun shield. Approval from appropriate authorities (PWD/railways) as applicable shall be taken by contractor.
2.10	Laying of Single Core Cables	<ul style="list-style-type: none"> a) The single core cables shall be laid in trefoil formation. Single core cables can be laid individually in HDPE pipe in case of HDD only. (Details of HDPE Pipe as per Annexure-9) b) For single core cables laid in trefoil formation, plastic cable ties shall be used at interval of 1.0 (one) meter throughout the cable length to maintain the trefoil arrangement. c) To balance the inductance, the phase sequence in trefoil format shall be maintained by vendor (for double circuit) d) To prevent magnetic losses (eddy current and hysteresis losses), the base plate of the panels or the terminal box of the equipments, shall have aluminium plate. In case the entry into the building is through GI pipe, a “slit” in the GI pipe shall be necessary. Alternatively GI pipes may altogether be avoided and non-metallic pipes such as PVC or HDPE pipe shall be used. Concrete pipes having steel reinforcement (RCC pipe) are not to be used.
2.11	Earthing of Single Core Cables	<ul style="list-style-type: none"> a) Single point bonded earthing shall be employed to prevent flow of induced circulating current in the armour and screen and consequential de-rating of cables for feeder less than 2.0 KM. b) For feeder length more than 2 KM, mid point earthing shall be provided.
2.12	Violation of barricading guideline and safety norms	On violation of barricading guideline and safety norms, a fine of Rs.5000 /day shall be imposed. BRPL inspector/engineer in-charge shall be empowered to impose the above penalty.

3.0 General guidelines for Laying Cables

S. No.	Parameter	Details
3.1	General	<ul style="list-style-type: none"> a) Laying of the cables and handling of the same shall be undertaken, at all times, by adequate staff suitably trained and supplied with all the necessary plant, equipment and tools. b) The contractor shall be responsible for all the route survey, establishment of the position of the joints as per the site exigencies and the drum lengths of cables to be laid. While carrying out the route survey the contractor shall take into account the obstacles on the route whether above or below ground. The cable shall be planned to be laid in an orderly formation, free from unnecessary bends and crossings c) The contractor shall submit a drawing for the complete scheme

		<p>showing the entire route, road crossings, location of joints and also the arrangement of cables to be laid. In case due to site exigencies, cables have to cross over within the trench, the same shall be shown in the drawing. For each and every job, these drawings shall be approved by BSES, prior to commencement of work.</p> <p>d) BSES shall arrange for all the material and manpower required for jointing and end termination. The Contractor shall provide pit, carry out excavation for creation of working space required for jointing by the jointer. All civil works, structural work, clamping and earthing shall be carried out by the contractor, so that the cables and accessories perform satisfactorily during the entire life time.</p> <p>e) The entry and exit of the cables into the building shall be through RCC or GI pipe except for single core cables, which shall be properly sealed and shall be duly supported as per the method and technique approved by BSES, so that the outer sheath of the cable does not get damaged at the entry and exit points. The sealing should be of adequate length so that it minimizes the risk of spreading of fire or ingress of water.</p>
<p>3.2</p>	<p>Handling and Storage of Cable drums (All empty drums are returnable)</p>	<p>a) The cable drums shall be transported upright, so that the weight is distributed on both the flanges. Under no circumstances the cable drum may be laid on its side. During transportation the drums must be properly secured. The cable drums should never be dropped from Lorry or a trailer, so as to prevent damage to the cable drum and also to the cable. Ramp may be used for unloading. The drums may be rolled over short distance, provided the correct direction of rolling as provided on the drum is observed. Alternatively, a mobile crane should be used for lifting and lowering the drum. A chain-pulley arrangement may also be used to lift the drums and deposit the same on ground if required.</p> <p>b) In case the drums are to be stored prior to cable laying, they should be arranged in such a way to leave some space between them for air circulation. It is desirable that the drums stand on battens placed directly under the flanges. Overhead covering is not essential except in heavy rainfall areas or during monsoon. Cable should however be protected from direct rays of sun by leaving the battens on or by providing some form of sunshade. In no case the drums shall be stored in a flat position with flanges horizontal.</p> <p>c) For transportation of the cable drums from storage site to work site, the drum should be mounted on a trailer or an open lorry and unloaded by mobile cranes.</p> <p>d) After cable laying, empty cable drums shall be taken return back by vendor from site at their own risk and cost. Cost of empty drums shall be deducted from vendor account during final settlement.</p>
<p>3.3</p>	<p>Cable Laying</p>	<p>a) The ground over which the drum is positioned at site should be</p>

		<p>properly consolidated and jacks placed on both sides of the drum to make the pay-off arrangement stable. Suitable arrangement be made to stop the drum rotation, during cable laying preferably by square wooden poles kept temporarily pivoted over cable roller under the flanges which when required can be applied on the flange as a brake by personnel manning the drum.</p> <ul style="list-style-type: none"> b) The cable should always be paved off from the top of the drum. The drum must be positioned in such a way that the arrow on the drum points opposite to the direction of rotation marked on the drum. c) It must be ensured that the cable is not dragged over sharp object or on the road surface, so as to avoid damage to the outer sheath of the cable. d) The pulling method to be used shall be approved by BSES. Cable supplier's recommended maximum pulling tension shall not be exceeded. e) Rollers shall be placed at intervals and the cable shall be pulled over the rollers. The rollers shall be kept lubricated so that they rotate freely, minimize friction to the cable in motion. Rollers shall be positioned at the bends to minimize side wall friction. The contractor shall ensure that PVC/HDPE sheath of cable is free from damage due to abrasion. f) The cable should not be pulled out from the drum by lifting of the coil while the drum is lying flat on the flange. This leads to twisting of the armour and cores resulting in permanent damage to the cable. g) To avoid ingress of moisture, it must be observed that the end capping of the cables is not damaged. Cut pieces of the cables must be capped immediately, before laying of the same is taken-up.
<p>3.4</p>	<p>Excavation of the Trenches</p>	<ul style="list-style-type: none"> a) The excavation of the trenches shall be commenced, with proper co-ordination with BSES, so that all the necessary clearances for the route are already obtained from the competent authorities, well in time. b) Before opening of the section of the trench, the contractor shall satisfy himself that the line of the trench is clear of underground obstructions, by taking out trial pits on the line of the trench. c) The exact location of each trench shall be approved on site by BSES. The trenches shall be kept as straight as possible and each trench shall be excavated to approved formation and dimensions. If necessary, the trenches shall be adequate shored by wooden planks and bracing to avoid trench cave-ins which would cause injury to the persons and also damage the cables laid. d) The bottom of each trench shall be firm and of smooth contour. The contractor shall take reasonable precautions to prevent damage to the highway or ground surface from a slip or breaking away of the sides of the trench. e) The trench excavation and filling in shall be so executed that all

		<p>walls, roads, sewers, drains, pipes, cables, structures, places and things shall be reasonably secured against risk of subsidence or injury and shall be carried out to the satisfaction of the authorities concerned. Should, however, a damage to an existing or other services be made, the Contractor will arrange and pay for any necessary repair, to make good the damages.</p> <p>f) Where trenches pass from a footway to a roadway or at other positions where a change of level is necessary, the bottom of the trench shall rise or fall gradually. The rate of rise or fall shall be approved by BSES.</p> <p>g) Contractor shall ensure that during excavation and until restoration has been completed, for reasonable access of persons and vehicles to property or places adjacent to the route.</p> <p>h) When the excavation of the trenches has been accurately executed, the contractor shall inform BSES for approval. Laying of cables or building of structure shall not be started until the contractor has been advised by BSES to proceed with the work.</p>
<p>3.5</p>	<p>Excavated material</p>	<p>a) The materials excavated from each trench shall be placed so as to prevent nuisance or damage to adjacent ditches, drains fences, gateways and other property or things. Excavated material shall be stacked so as to avoid undue interference with traffic.</p> <p>b) Where, owing to traffic or for reasons of safety or other considerations, this is not permissible, the excavated material shall be removed from the site and returned for refilling the trench on completion of laying; surplus material shall be disposed off by the contractor at his own cost.</p>
<p>3.6</p>	<p>Pipes and Ducts</p>	<p>a) Care shall be taken to make the bend of the pipes or duct lines as easy as practicable and in no case of radius less than 3 meters. Where approved, split pipes may be used on bends, the pipes being fitted round the cable after laying.</p> <p>b) All road crossings shall be ducted. This applies to present and future roads as indicated on the route plans. The pipes and the ducts shall be laid in an approved manner and shall be surrounded by 150 mm of PCC (1:2:4)</p> <p>c) Ducts under the road shall be provided by the contractor, by non-disruptive method, if road cutting is not permitted by the concerned authorities Cable laying shall be done by Horizontal Direct drilling method (HDD).</p> <p>d) The cables shall be suitably protected at entry and exit from the pipes, so that the outer sheath does not come in contact with the edges of the pipes / ducts. The pipes and ducts shall have slope so that the seepage water can drain through the small opening provided on the lower side of the pipe sealing.</p> <p>e) The pipes and ducts shall be secured to the base at both ends and at regular interval, throughout the length, so that at no point the ducts or pipes get suspended over the threaded cable, and damage the same, thus defeating the very purpose of providing the pipe / duct.</p>

		<p>f) At all road crossings at least one spare duct / pipe shall be provided for future use. The pipe shall be thoroughly cleaned of obstructions. A draw wire or rope shall be left in each pipe to facilitate the drawing in of the cables. The duct end shall be sealed temporarily to prevent the entry of foreign matter. End caps and permanent markers shall be placed flush with footpath / roadways at both the ends. The pipes and ducts shall be cleaned again immediately before the cables are drawn in.</p> <p>g) The internal diameter of the pipe / duct should be such that the cables occupy only 40% of the area of the pipe / duct to avoid de-rating.</p>
3.7	Joint Bays	The contractor shall provide all help so as to enable jointers to carry out their work efficiently and expeditiously. The method of securing and supporting cable joints and cables also the bonding and earthing thereof, shall be detailed on the drawing. The details shall be approved by BSES prior to commencement of work. The joint position should be staggered.
3.8	Back filling of trenches	<p>a) Filling in of trenches shall not be commenced until BSES has inspected and approved the cables and accessories at site. The inspection should be got done on daily basis so that the trenches do not remain open unnecessarily, to avoid inconvenience to public.</p> <p>b) The trench shall be backfilled after putting all protections for cables.</p> <p>c) Soft soil shall be backfilled for 300 mm above the cable protection cover.</p> <p>d) Caution Tape shall be laid all along the cable route above the soft soil filling.</p> <p>e) Complete backfilling shall be done above the caution tape.</p>
3.9	temporary Reinstatement	<p>a) Where cables routes are in public highways, footpaths, gardens etc., the method of reinstatement will be subject to approval by MCD. All costs incurred will be at the contractor's expenses.</p> <p>b) The contractor shall be responsible for proper permanent reinstatement of the upper levels, which shall be carried out to the satisfaction of BSES and the MCD authorities concerned.</p> <p>c) Before finally leaving site, permanent reinstatement shall be executed by the contractor to the approval of MCD and the property owners and all costs incurred shall be to the contractor's account.</p>
3.10	Permanent Reinstatement of Public Road,	<p>a) In public roads and footways the surfaces and foundations shall be temporarily reinstated by the contractor. After settlement, temporary reinstatement material shall be removed as necessary and the permanent reinstatement shall be carried out to the approval of the appropriate highway authority / MCD. Stone and pre-cast concrete paving kerbs and channels shall also be finally reinstated by the contractor.</p> <p>b) Temporary reinstatement shall be maintained by the contractor until commencement of final reinstatement to ensure that the surface is always safe for the passage of pedestrians and vehicular traffic.</p>

3.11	Identification	All cables shall be identified below the gland at each end, at joint position and at approved positions by means of bands engraved or punched with cable no. feeder name, size of cable, number of cores, phase colour etc. The bands shall be secured fastened in a permanent manner, and shall be made of material able to resist corrosion, dampness and mechanical damage.
3.12	Cable Route Markers	All cables routes shall have markers at suitable location with a gap not exceeding 30 meters. The route markers shall be approved design. Additional markers shall be provided at joint locations with approved markings.
3.13	Cable supports / Clamps	<ul style="list-style-type: none"> a) The contractor shall supply and install all the supports, racks, trays, cleats, saddles, clips and other parts required to carry and secure the cables, without risk so that there is no undue mechanical load or stress due to weight of the cable at each end. Cleats, saddles and clips shall be of the design as approved by BSES. No cable shall be laid on the trench floor. They shall be run in a neat and orderly manner and the crossing of cables within the trench shall be avoided as far as possible. Where cable runs unavoidably cross, a suitable supporting arrangement shall be provided to maintain an adequate gap between the cables b) Every cable shall be supported at a point not more than 500 mm from its termination.
3.14	Installation of Cables in tunnels / basement / below the panels etc	<ul style="list-style-type: none"> a) The design of cable support for cables installed in air in cable tunnels, basements etc. shall consist of vertical steel members spaced at approved interval and secured to the walls, floors and ceilings as necessary by means of bolts either cemented in position or expanded into cored holes. Each vertical support shall have bolted to it a number of steel brackets spaced at the intervals and designed to support and retain trays constructed of galvanized sheet steel of adequate section to carry the weight of the cables, plus space for an additional quantity of future cables at least 25% by weight and dimensions in excess of the cables installed under the contract and an additional load of 100 kg at the extremity without distortion. The trays shall be designed with raised edges to retain the cables and shall incorporate an interlocking feature so as to prevent movement between supports. b) The design and construction of all cable cleating and supporting arrangements shall suit the cable system design. The spacing of cable supports shall be approved by BSES. c) Cable run on trays shall be neatly dressed and where not provided with cleats shall be secured by heavy gauge, type approved metal reinforced, clips or saddles. Not more than six cables shall be embraced by one clip. d) Mild steel of appropriate sections, duly painted in an approved manner, shall be used for fabrication of cable supports. The steel shall be free from blisters, scales, laminations or other defects. Before final painting, the steel sections shall be provided with double coat of red primer.

3.15	Cable Protection at overhead Towers or Poles	Where the cables terminate on overhead line poles or towers located outside substation compounds the contractor shall provide suitable cable supporting galvanized steel work attached to the pole or tower and comprising backboard, runners, sheet, steel cover of not less than 3.0mm thickness, stays, cable cleats, anti climbing guard and all incidental items to provide secure protection for the cables. Isolators and Lightning arrester if required to be installed shall be provided as free issue item to the contractor, however the erection and steel structure required shall be in scope of the contractor.
3.16	Sun Shades	All cables shall be protected from direct solar radiation by ventilated sun shields as approved by BSES.
3.17	Route Plan	<ul style="list-style-type: none"> a) BSES intends to show all the cable routes, location of joints and other underground obstructions on a GPS map. b) During the progress of the contract works the contractor shall record on a set of route plans and cross section drawings of an approved form, these details so that the same can be transferred on the GPS maps. Such particulars will allow an accurate reference to be made in the case of any fault or projected modification. These records shall show, amongst other data, both indoors and outdoors the exact position of every joint, cable end termination and also the particulars of the depth of the trench, the arrangement of the cables, with cable numbers and the position of all obstructions revealed during the course of excavations. These completed records shall be submitted to BSES within 15 days of completion of any particular route/feeder. The final bill shall not be processed by BSES unless this activity has been completed to the entire satisfaction of BSES
3.18	Site Facilities to be maintained by the Contractor	<ul style="list-style-type: none"> a) The contractor shall arrange for all the tools and tackles required for cable laying as per this specification. BSES shall arrange for all the material and manpower required for jointing and end termination. b) Illumination and Power supply shall be arranged by the contractor so that the work can be carried out round the clock. c) The contractor shall maintain functional dewatering pumping facility with suitable power supply so as to protect the cables and the joints from ingress of water due to rain or otherwise d) The contractor shall make arrangement to provide suitable scaffolding arrangement to carry out the termination work e) The contractor shall carry out proper barricading of the dug cable route and the joint bays and shall take all necessary precautions to avoid any public hazard f) Also refer Annexure-7: Barricading and Safety.
3.19	Type of Roads and guidelines for road restoration	<p>The typical section of type of Roads (based on width) under PWD and MCD are :-</p> <ul style="list-style-type: none"> - 20 Feet Wide road - 30 Feet wide road - 40 to 60 Feet Road - Other (which include Kota stone, Agra stone, Cement concrete, interlocking paving tiles, brick road, chequered tiles

		<p>and asphalted road)</p> <p>The drawing are shown in annexure IV</p> <p>The guidelines for road restoration for various type of roads and surfaces are indicated in annexure V as :-</p> <ul style="list-style-type: none"> - Bituminous road Type I (category I & II) - Bituminous road Type II (category III) - Cement concrete road - Kota/Rajasthan stone Road - Brick Road - Interlocking paving tiles. - Agra stone road - Chequered tiles road - Asphalted road
--	--	---

4.0 Testing

S. No.	Parameter	Details
4.1	Tests to be carried out during and after completion of Cable Laying	<p>Testing of cable before jointing –</p> <ul style="list-style-type: none"> - Cable shall be tested for Insulation Resistance prior to laying by opening the end and resealing end properly. <p>Testing on complete Cable Installation –</p> <ol style="list-style-type: none"> a) Insulation resistance of each core shall be measured against all the other cores and the metal screen connected to earth. b) The resistance of the conductor shall be measured. c) DC High voltage. For old cables test voltage shall be 1.5 times rated voltage or less depending on age of cable.(refer annexure # 2 for values) d) Charging of Cable at No-Load at Nominal working voltage for 24 Hours. e) After laying and before termination of cable a sheath test shall be conducted for 66KV Single core Cable as under :- <p>At both ends the cable shall be raised from ground. From the end graphite coat applied over the outer PVC jacket shall be removed with a piece of glass for a length of 300mm. A spiked steel rod with an eye for attaching a wire shall be driven into the ground and connected to a nearby water or hydrant pipe. Insulation resistance of PVC jacket shall be measured between the aluminium wire armour and the spike with a 500/1000V insulation tester. Measured resistance shall not be less than 2.5M OHM per KM. Thereafter 10KV DC shall be applied for one minute in the same way. After the test the armour shall be kept earthed to the steel spike for 15 minutes for discharging residual charge.</p>
4.2	Statutory	<ol style="list-style-type: none"> a) Road cutting permission

	clearance	<p>Road cutting permission shall be taken from competent authority by vendor. How ever official fees shall be paid by BRPL.</p> <p>b) Electrical inspector clearance Electrical Inspector clearance shall be in vendor scope. How ever official fees shall be paid by BRPL.</p>
--	------------------	---

5.0 Progress Reporting:

S. No.	Parameter	Details
5.1	Detailed Progress report	<p>Progress report to be submitted by Contractor to BSES once in a Week containing</p> <ul style="list-style-type: none"> i) Excavation status ii) Cable laying status iii) Status of preparedness for Jointing iv) Reason for any delay in total programme v) Details of damage to cable during laying. vi) Progress on final completion / Constraints / Forward path

6.0 Drawing, Data & Manuals:

S. No.	Parameter	Details
6.1	To be submitted After Completion of the Job	<p>As the works is completed the following reports in quadruplicate shall be submitted to BSES for record purpose and shall be incorporated in the 'As constructed Records'.</p> <ul style="list-style-type: none"> a) Feeder details (sending end, receiving end, SAP number of project etc) <ul style="list-style-type: none"> - Type of cables, cross section area, rated voltage. Details of construction, cable number & drum number. - Year and month of laying. - Actual total route length, cable length, length between joint to joints or end. - Location of cables and joints in relation to certain fixed reference points, for example buildings, hydrant, boundary stones etc. - Jointing reports detailing the date, weather conditions, jointers and supervising Engineers names, details of type of cable and type of joint or termination, location and joint bay number, ambient temperature. - Results of original electrical measurements and testing on cable installation. - Full written reports will be required of any damage occurring to cable or equipment together with remedial action proposed which will be subject to the approval of BSES.
6.2	Drawing and document sizes	Standard size paper A0, A1, A2, A3, A4

7.0.0 Deviations

Deviations from this Specification shall be stated in writing by the contractor. Written approval shall be obtained from BSES by the contractor. In absence of such a statement, it will be assumed by BSES that the Contractor complies fully with this specification during execution of the job.

Deviation mentioned in any other submitted tender docs like in GTP, QAP, Old PO, old WO, BRPL Standard, vendor standards etc. shall not be considered as a deviation at any stage of contract.

The format for approval of deviation attached in annexure # 1

Annexure # 1 – DEVIATION REPORT FORMAT

S. NO.	Clause No. of Specification	Details about deviation	Reason for deviation	Approved by (Sign & Name)

Annexure # 2 – DC HIGH VOLTAGE TEST

Rated Voltage of cable in KV	Test Voltage Between		Duration in Min.
	Any conductor and metallic sheath / Screen / armour	Conductor to conductor (for unscreened Cables)	
0.65 / 1.1	3	3	15 Min
6.35 / 11	18	30	
19 / 33	60	----	
38 / 66	90	----	

Reference value for DC High voltage Test.

Annexure # 3 – CABLE TRENCH DETAILS

S. No.	Cable Size	Trench		Cable Trench drawing reference
		Width (mm)	Depth (mm)	
1	1.1 kV LT Cables			
a	3.5Cx150 mm ² - Single Circuit	400	875	A – 1 (Drg. # 9)
b	3.5Cx150 mm ² - Double Circuit	400	875	A – 1 (Drg. # 9)
c	3.5Cx150 mm ² - Triple Circuit	400	875	A – 1 (Drg. # 9)
d	3.5Cx300 mm ² - Single Circuit	400	875	A – 1 (Drg. # 8)
e	3.5Cx300 mm ² - Double Circuit	400	875	A – 1 (Drg. # 8)
f	3.5Cx300 mm ² - Triple Circuit	400	875	A – 1 (Drg. # 8)
2	11 KV Cables			
a	3Cx150 / 300 mm ² - Single Circuit	400	1055	A – 2 (Drg. # 6)
b	3Cx150 / 300 mm ² -Double Circuit	650	1055	B – 1 (Drg. # 7)
3	33 kV Cables			
a	3Cx400 mm ² - Single Circuit	400	1235	A – 3 (Drg. # 3)
b	3Cx400 mm ² - Double Circuit	650	1235	B – 2 (Drg. # 4)
c	3Cx400 mm ² - Quadruple Circuit	650	1235	B – 2 (Drg. # 5A)
d	3Cx400 mm ² - Quadruple Circuit	650	1545	B – 3 (Drg. # 5B)
e	3Cx400 mm ² - Quadruple Circuit	1200	1235	C – 1 (Drg. # 5C)
4	66 kV Cables			
a	1Cx630/1000 mm ² - Single Circuit	650	1445	B – 4 (Drg. # 1)
b	1Cx630/1000 mm ² - Double circuit	1200	1445	C – 2 (Drg. # 2)
c	3Cx300 mm ² - Double circuit	1200	1445	C – 2 (Drg. # 2A)

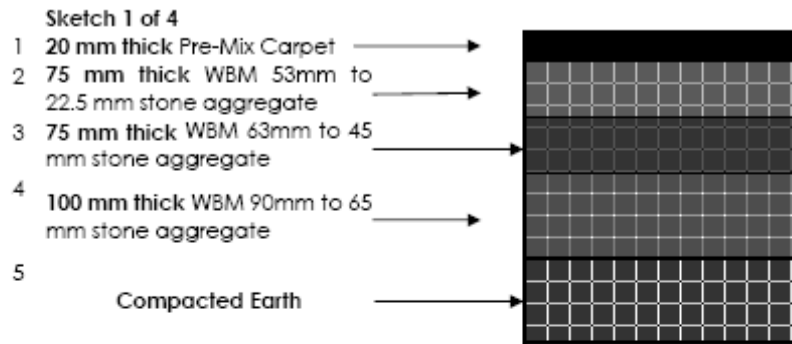
Annexure # 4 – Standard Road Profile**STANDARD ROAD PROFILE
20' - 00" FEET WIDE ROAD (Road type 1)**

Sketch 2 of 4 30' - 00" FEET WIDE ROAD (ROAD TYPE II)

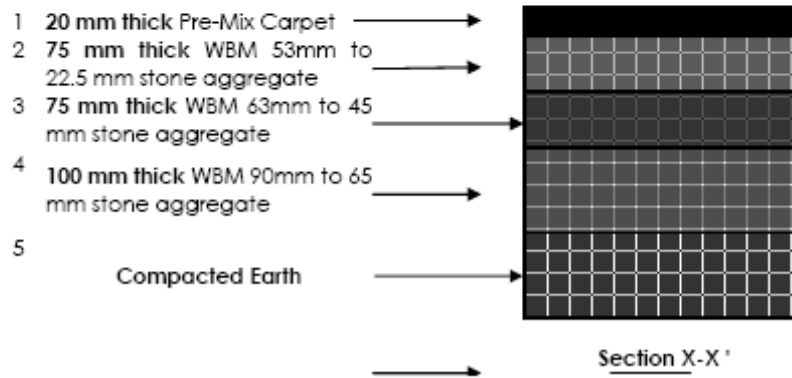

Sketch 3 of 4

40'-00" TO 60'-00" FEET WIDE ROAD

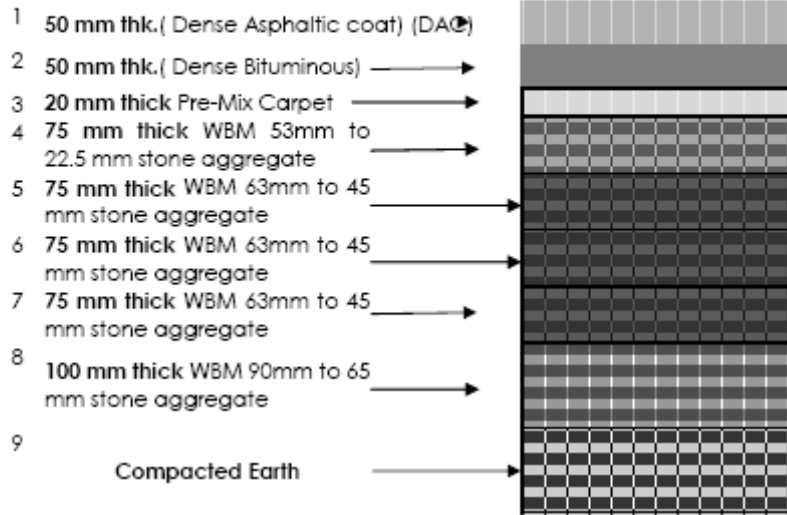

Section A-A'

Sketch 4 of 4

General drawing for cases other than roads.

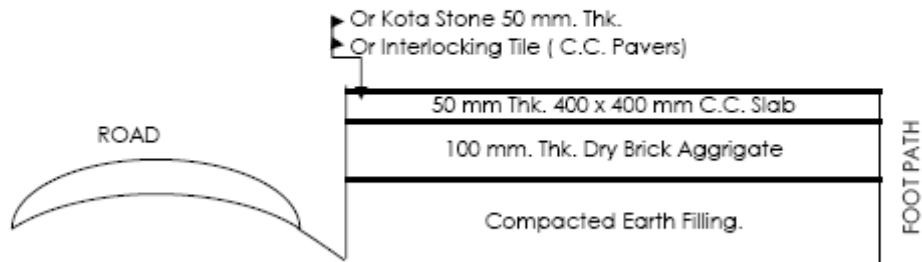

Details of Foot Path Along roads under PWD & MCD.

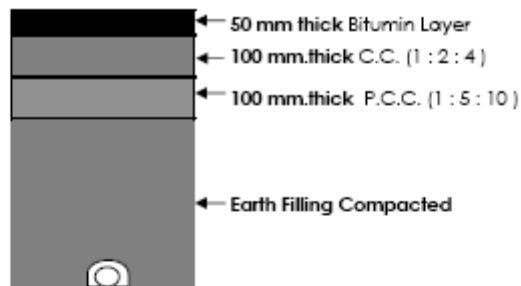
Annexure # 5 – Road Restoration Sectional Drawing**ROAD RESTORATION SECTIONAL DRAWINGS**

Bituminous Road Type - I (Category 1 & 2) Road width 20 to 30 feet and 30 to 40 feet.

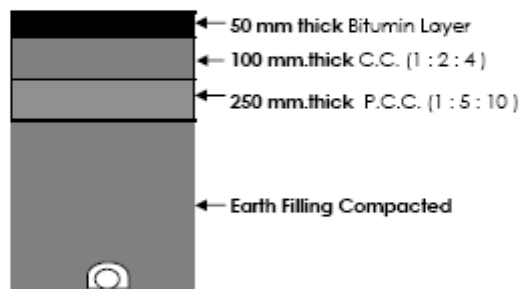

Bituminous Road Type - II (Category 3)

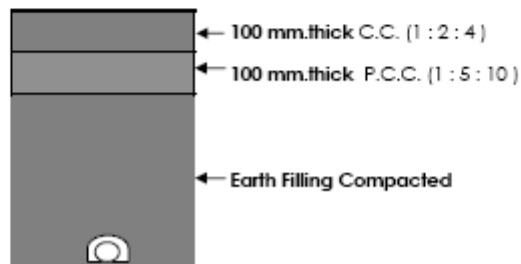

Cement Concrete Road

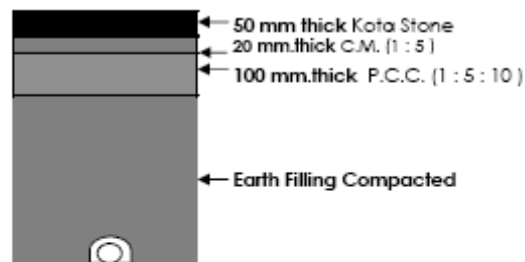
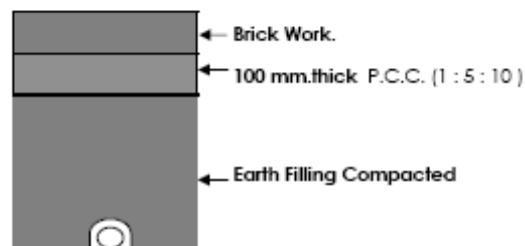
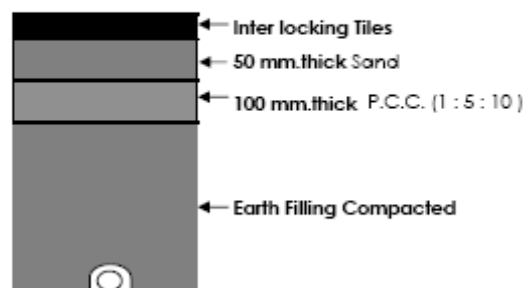
**Kota / Rajasthan stone Road****Brick Road****Interlocking Paving Tiles**

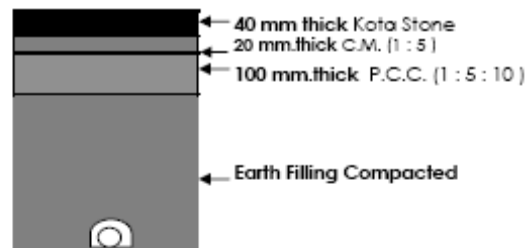

Agra stone Road .

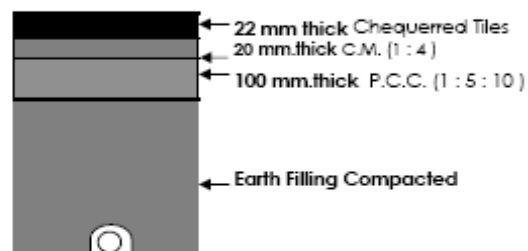

Chequerred Tiles .

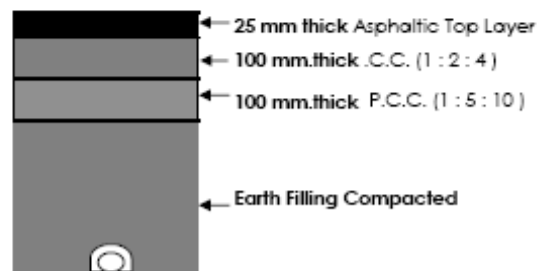

Asphaltic Road .

Annexure # 6 – DRAWINGS (CABLE TRENCH AND RCC CABLE COVER)

DRAWING # 1

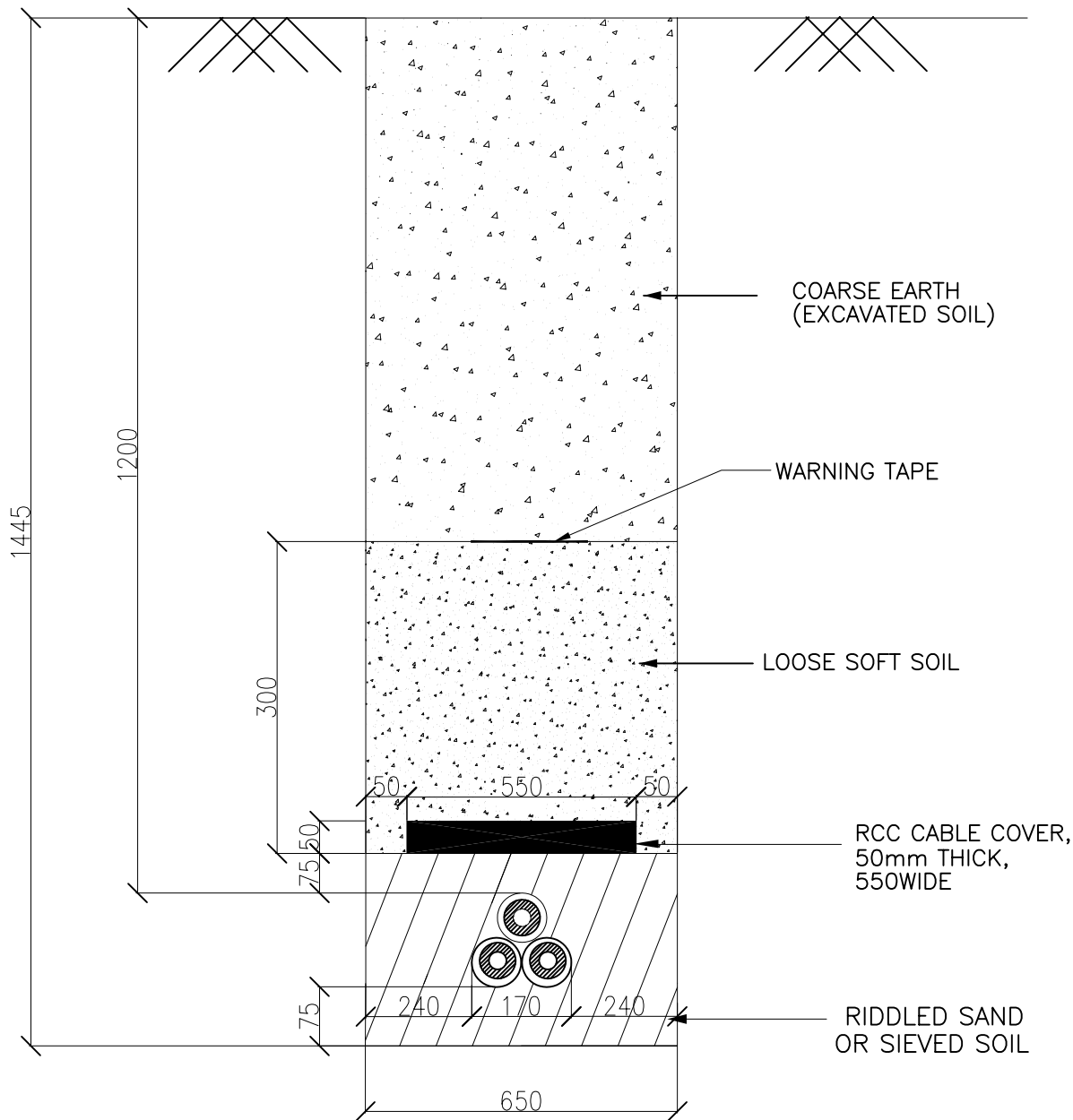

TYPICAL DETAILS FOR 66KV BURIED CABLE FOR SINGLE CIRCUIT TYPE – B 4

DRAWN	DS	TITLE: -
CHECKED	SGD	TRENCH DRAWING FOR
APPD.	D.GUHA	1C X 630 Sq. mm
DATE		66KV SINGLE CIRCUIT
SCALE		XLPE CABLE

BSES

REV.
00

DRAWING # 2

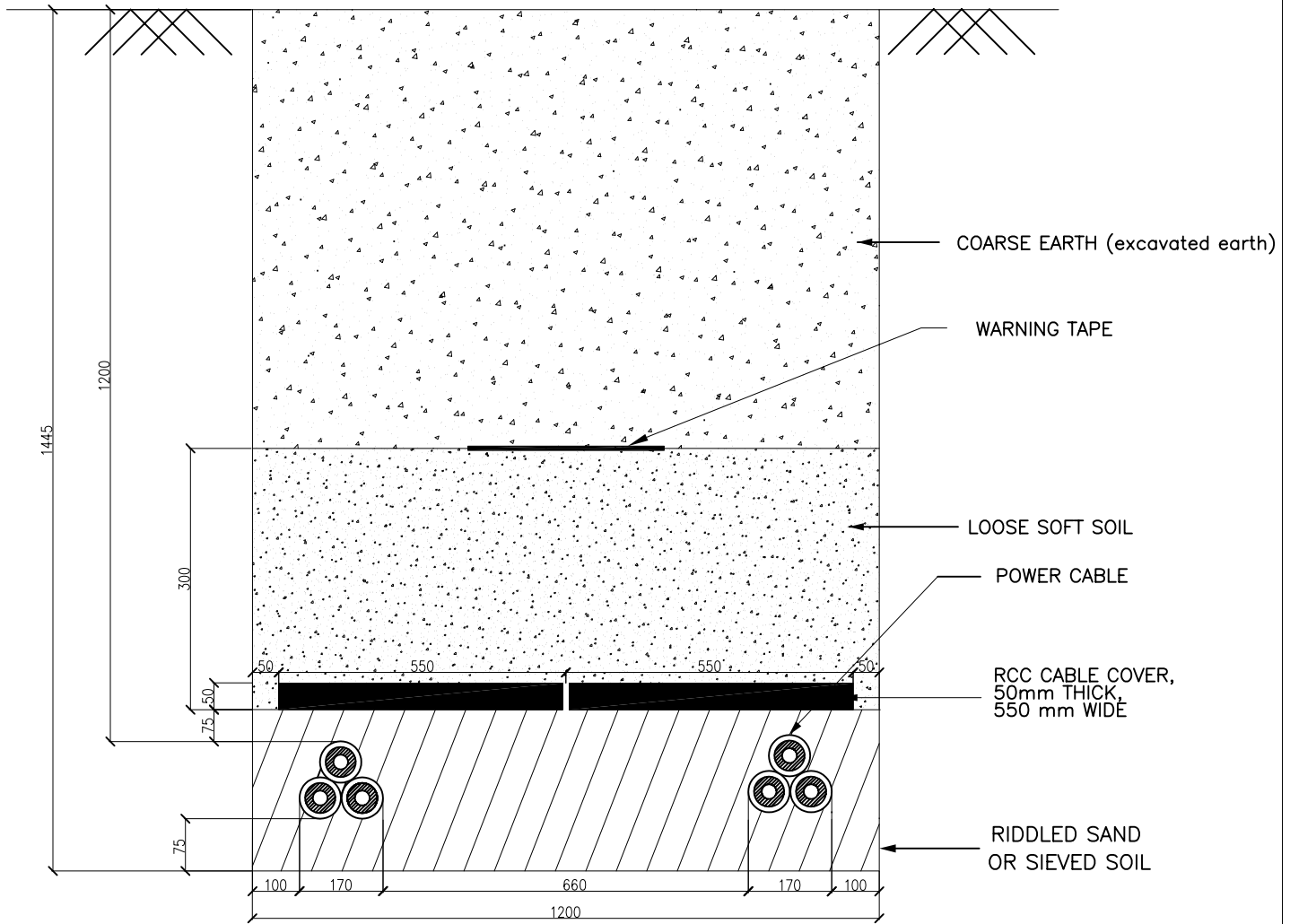

TYPICAL DETAILS FOR 66KV BURIED CABLE FOR TWO CIRCUIT
TYPE – C 2

DRAWN	DS	TITLE:- TRENCH DRAWING FOR 1C X 630 Sq. mm 66KV DOUBLE CIRCUIT XLPE CABLE	BSES
CHECKED	SGD		
APPD.	D.GUHA		
DATE			
SCALE			
			REV. 00

DRAWING # 2 A

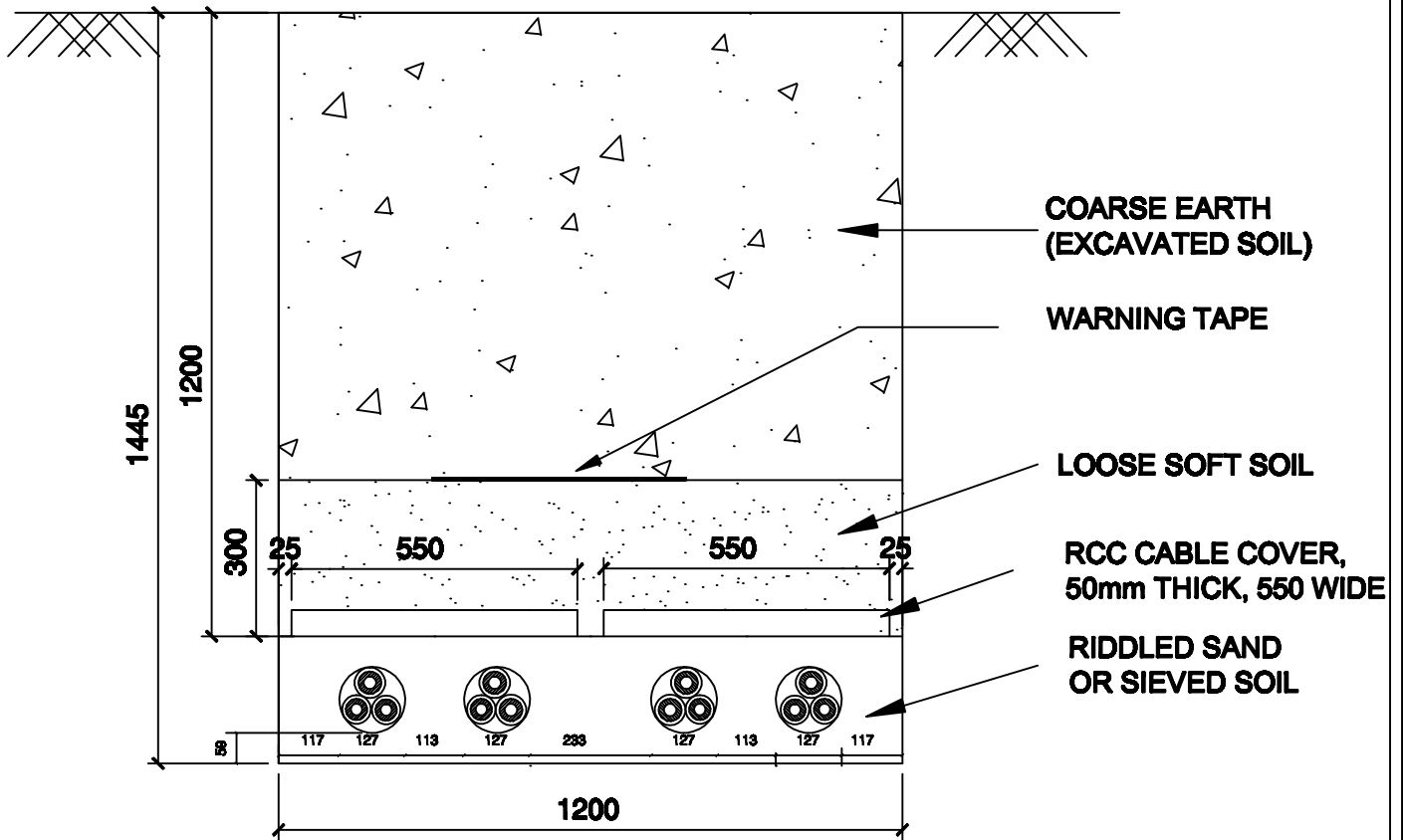

**TYPICAL TRENCH SECTION DETAILS FOR 66KV SINGLE
CORE 300 Sq. mm. BURRIED CABLE FOR DOUBLE CIRCUIT**

TYPE - C 2

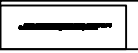
DRAWN	SAURABH	TITLE:-	 BSES Rajdhani Power Limited
CHECKED	A.S	TYPICAL TRENCH SECTION DETAILS FOR 66KV SINGLE CORE 300 mm BURRIED CABLE FOR DOUBLE CIRCUIT	
APPD.	K.S		
DATE	09.01.15		
SCALE			REV. 00

DRAWING # 3

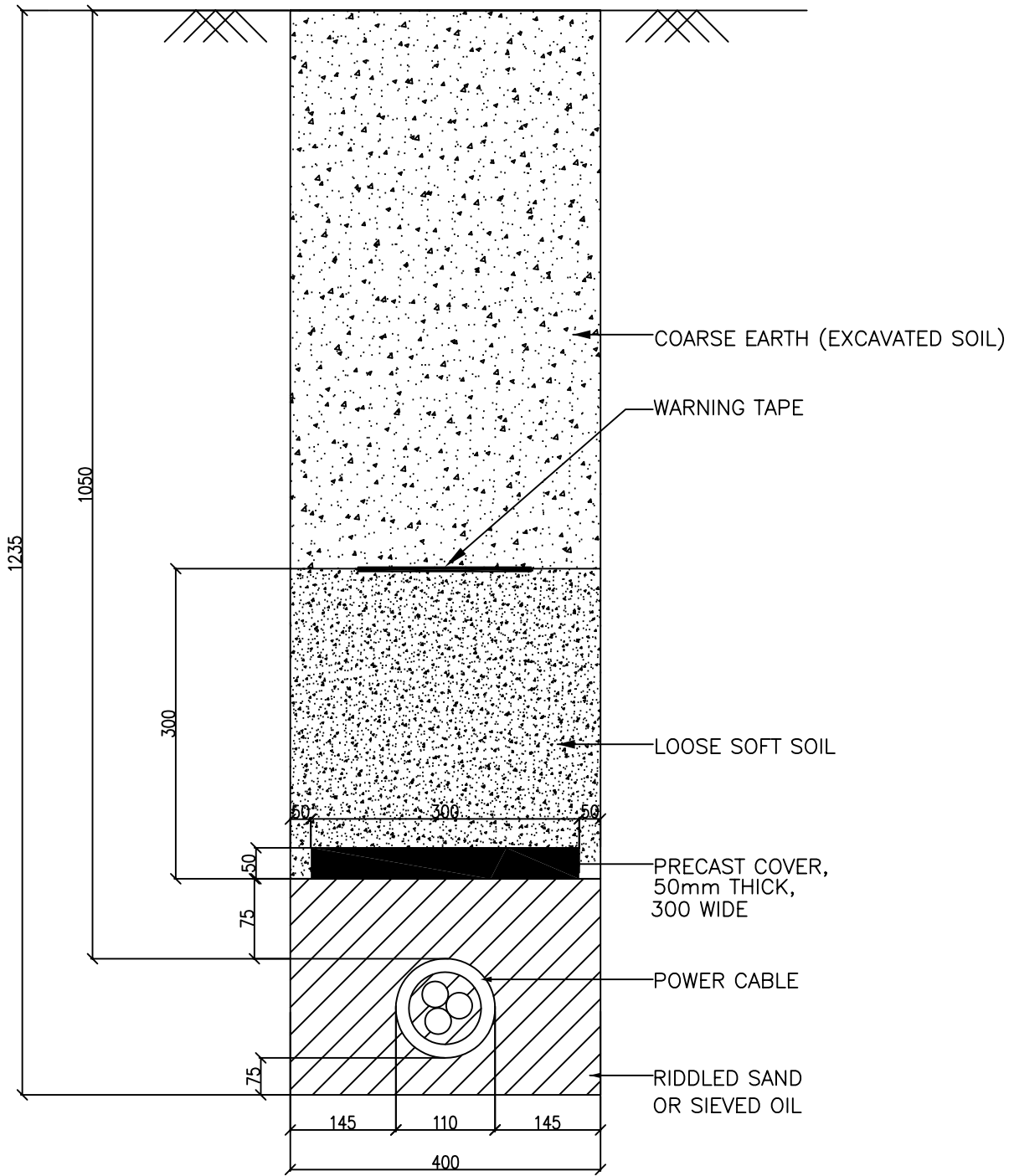

TYPICAL DETAILS FOR 33KV BURRIED CABLE FOR SINGLE CIRCUIT
TYPE - A 3

DRAWN	DS	TITLE:-
CHECKED	SGD	TRENCH DRAWING FOR
APPD.	D.GUHA	33KV 3CX 400 mm sq.
DATE		SINGLE CIRCUIT
SCALE		XLPE CABLE

BSES

REV.
00

DRAWING # 4

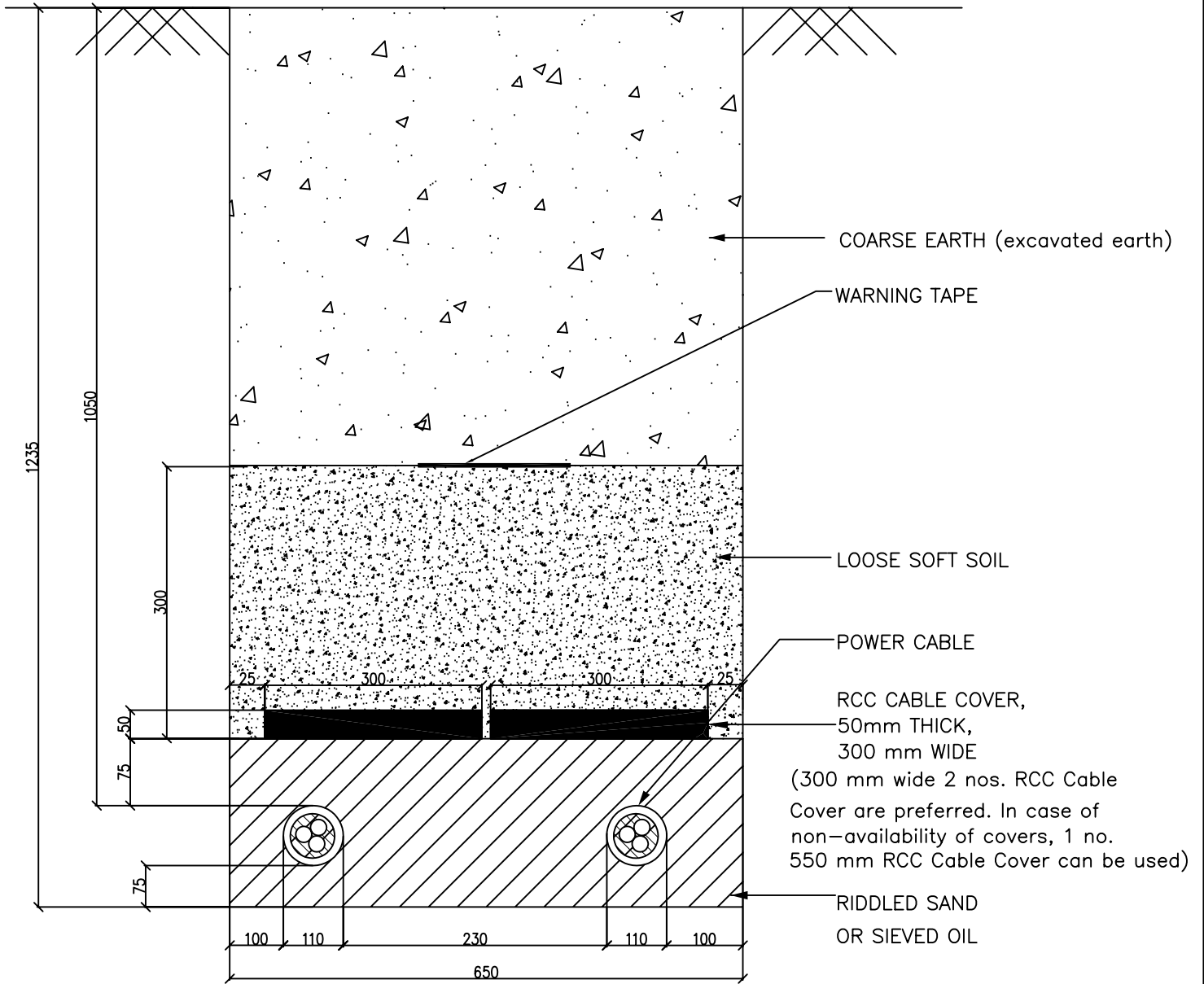

TYPICAL DETAILS FOR 33KV BURRIED CABLE FOR TWO CIRCUIT
TYPE - B-2

DRAWN	DS	TITLE:-
CHECKED	SGD	TRENCH DRAWING FOR
APPD.	D.GUHA	3C X 400MM2, 33KV
DATE		DOUBLE CIRCUIT
SCALE		XLPE CABLE

BSES

REV.
00

DRAWING # 5 A

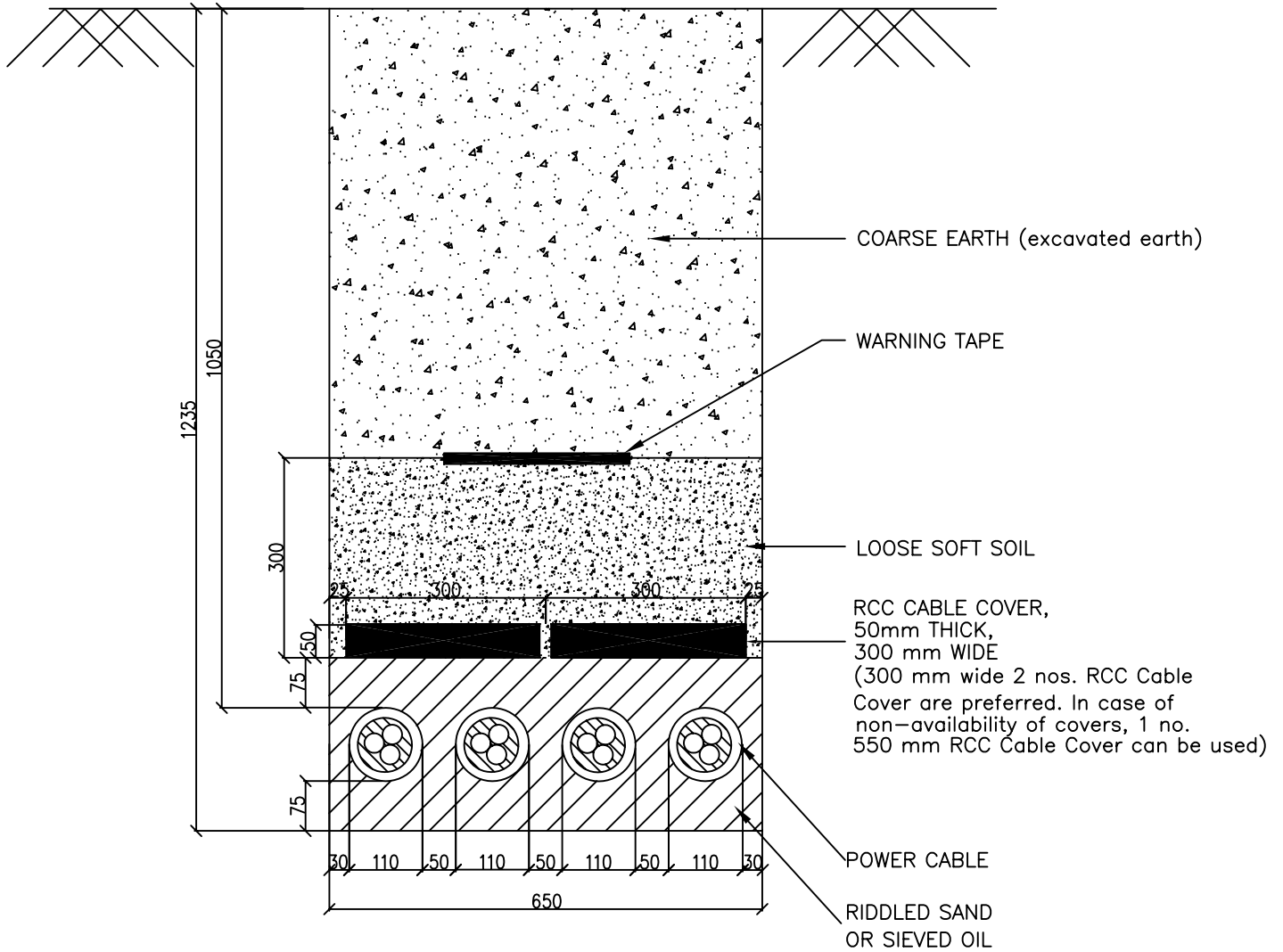

TYPICAL DETAILS FOR 33KV BURIED CABLE FOR FOUR CIRCUIT
TYPE - B 2

DRAWN	DS	TITLE:- TRENCH DRAWING FOR 3C X 400MM ² , 33KV FOUR CIRCUIT XLPE CABLE	BSES	
CHECKED	SGD			
APPD.	D.GUHA			
DATE				
SCALE				REV. 00

DRAWING # 5 B

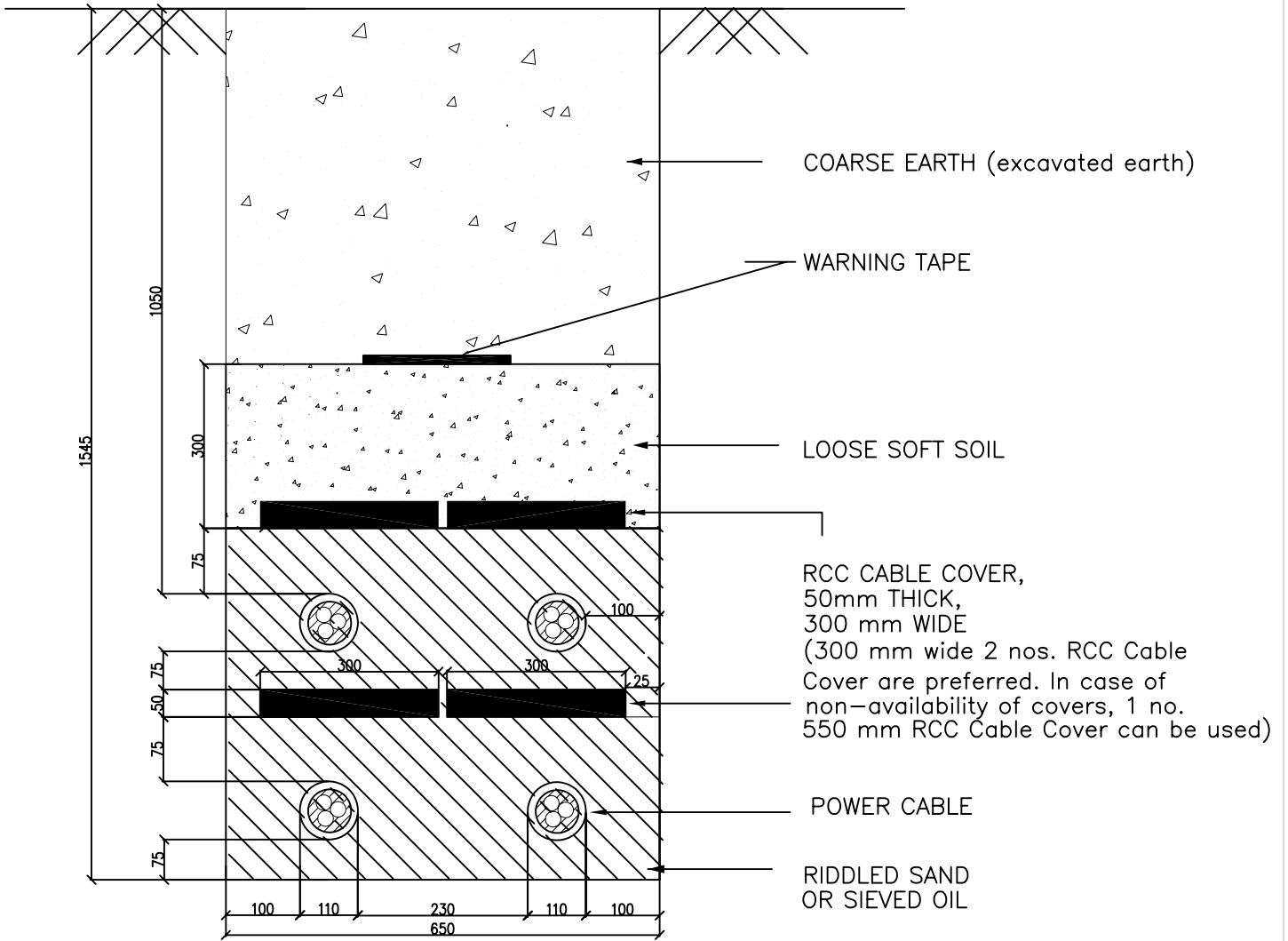

TYPICAL DETAILS FOR 33KV BURRIED CABLE FOR FOUR CIRCUIT
TYPE – B 3

DRAWN	DS	TITLE:--
CHECKED	SGD	TRENCH DRAWING FOR
APPD.	D.GUHA	3C X 400MM2, 33KV
DATE		FOUR CIRCUIT
SCALE		XLPE CABLE

BSES

REV.
00

DRAWING # 5 C

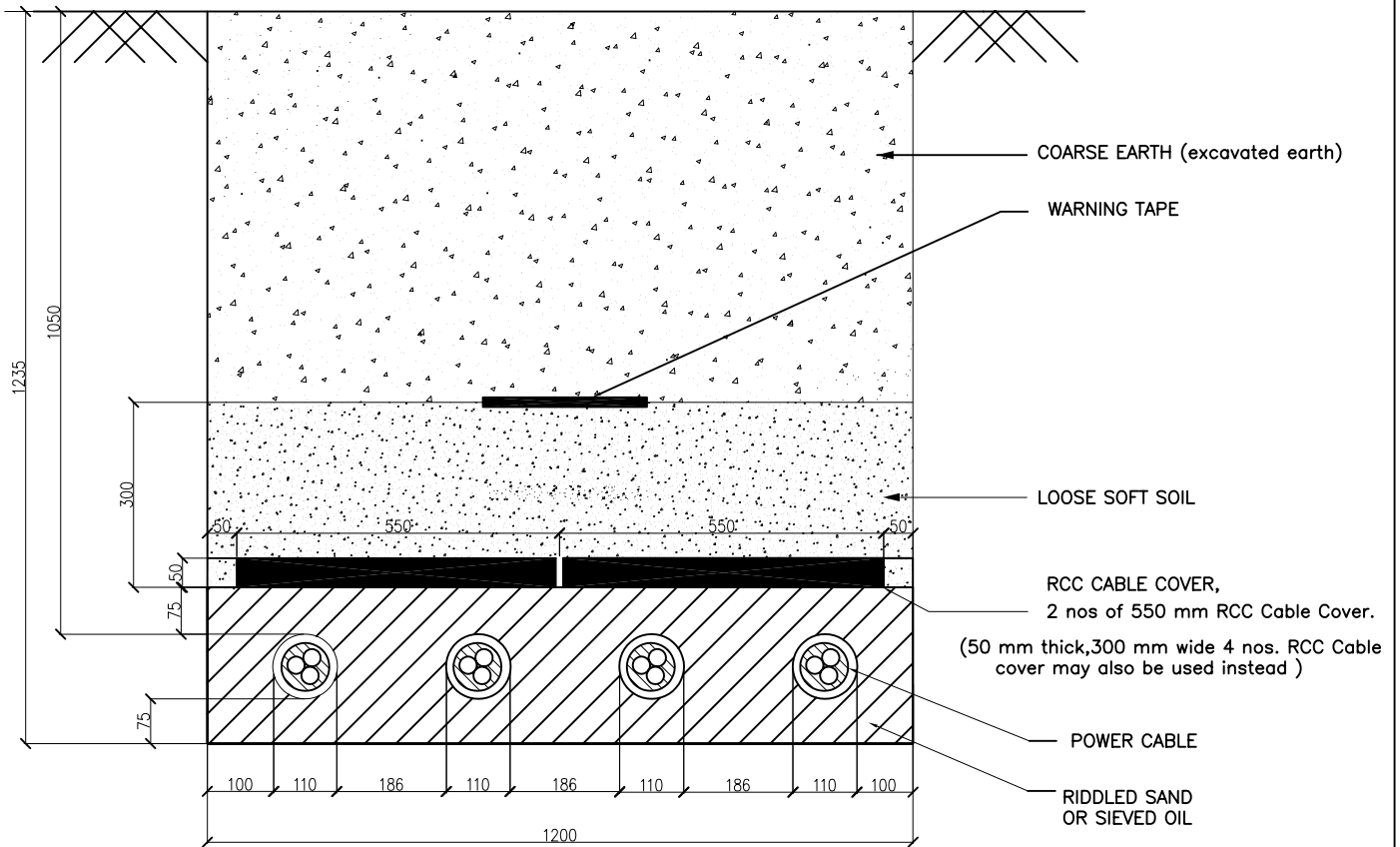

TYPICAL DETAILS FOR 33KV BURIED CABLE FOR FOUR CIRCUIT
TYPE – C 1

DRAWN	DS	TITLE:–
CHECKED	SGD	TRENCH DRAWING FOR
APPD.	D.GUHA	3C X 400MM2, 33KV
DATE		FOUR CIRCUIT
SCALE		XLPE CABLE

BSES

REV.
00

DRAWING # 6

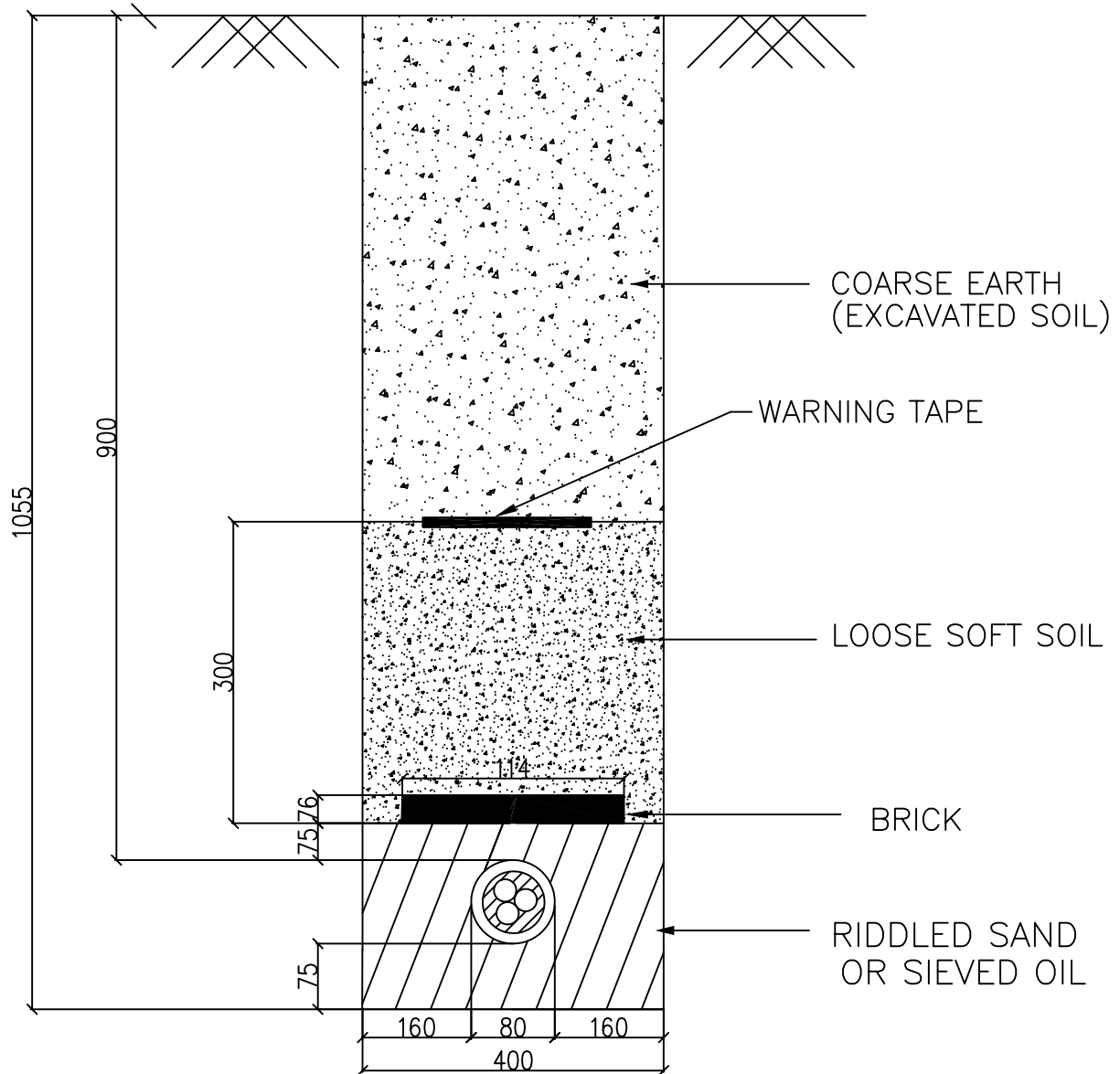

TYPICAL DETAILS FOR 11KV BURIED CABLE FOR SINGLE CIRCUIT
TYPE - A 2

DRAWN	DS	TITLE:-
CHECKED	SGD	TRENCH DRAWING FOR
APPD.	D.GUHA	3C X 300 Sq. mm
DATE		11KVSINGLE CIRCUIT
SCALE		XLPE CABLE

BSES

REV.
00

DRAWING # 7

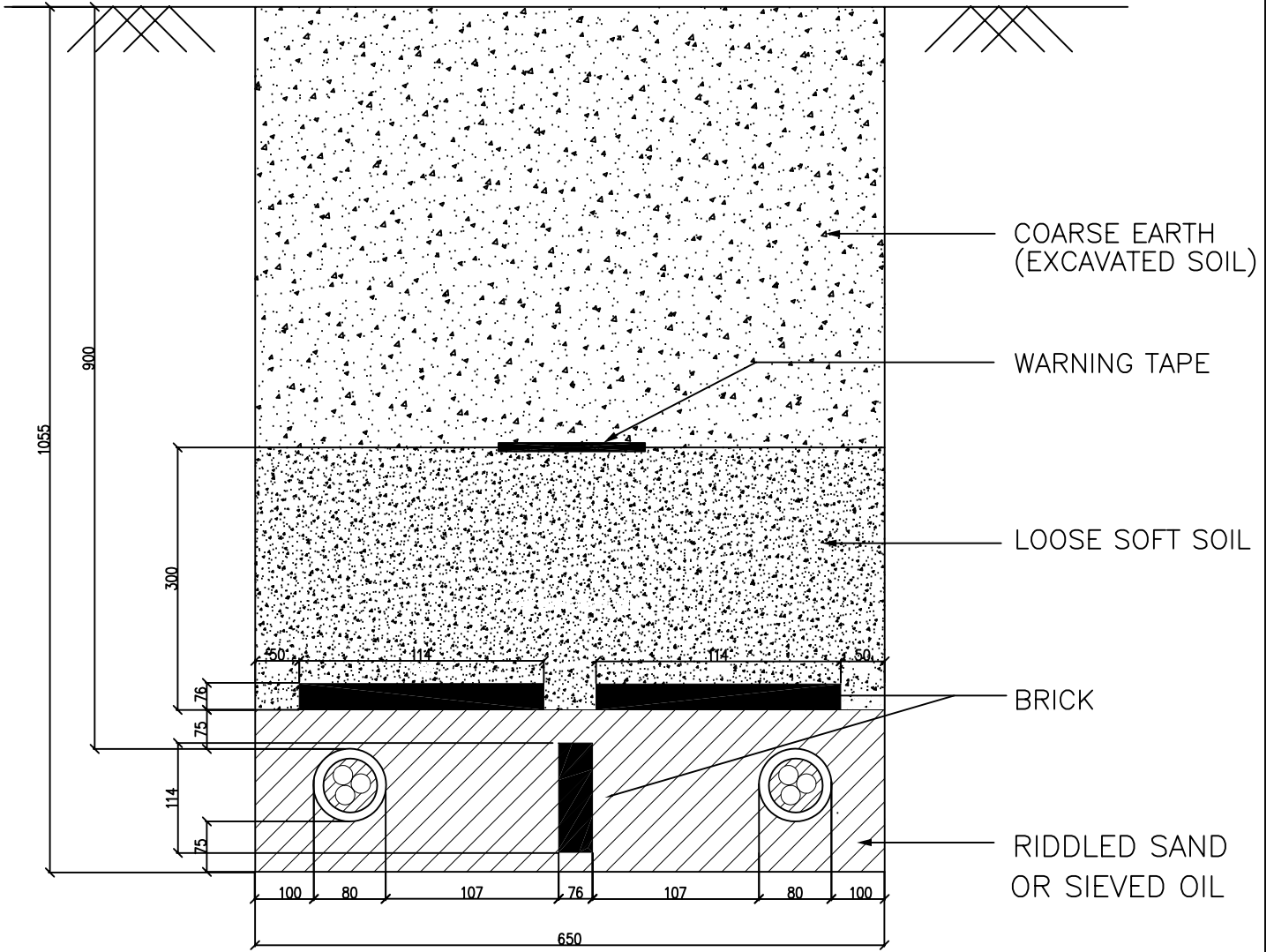

TYPICAL DETAILS FOR 11KV BURIED CABLE FOR TWO CIRCUIT
TYPE - B 1

DRAWN	DS	TITLE:-
CHECKED	SGD	TRENCH DRAWING FOR
APPD.	D.GUHA	3C X 300 mm Sq. or
DATE		3C X 150 mm sq
SCALE		11 KV DOUBLE CIRCUIT
		XLPE CABLE

BSES

REV.
00

DRAWING # 8

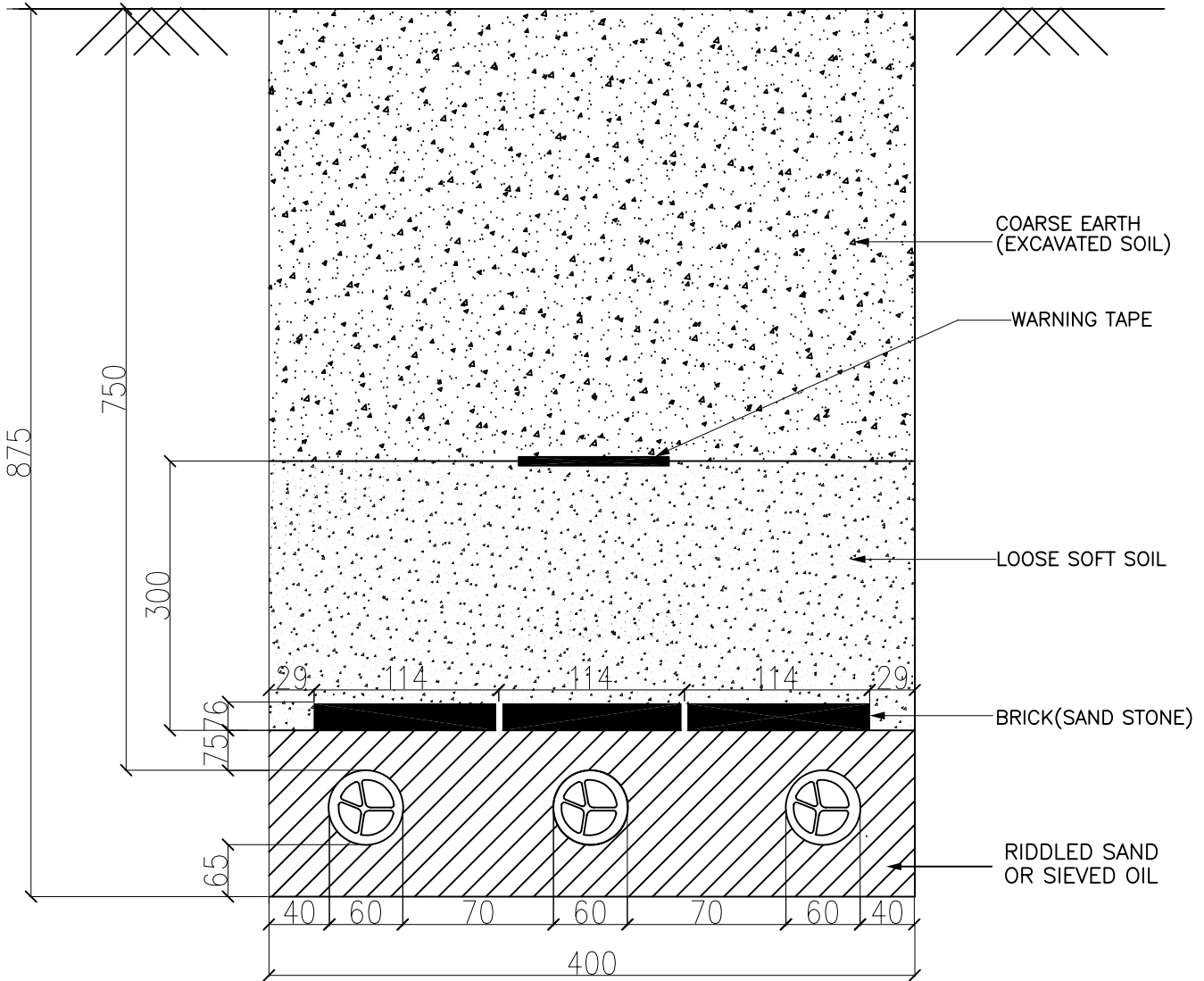

TYPICAL DETAILS FOR 1.1KV BURIED CABLE
TYPE – A 1

DRAWN	DS	TITLE:-	BSES
CHECKED	SGD	TRENCH DRAWING FOR	
APPD.	D.GUHA	3.5Cx300Sqmm 1.1 KV	
DATE		XLPE CABLE	
SCALE			REV. 00

DRAWING # 9

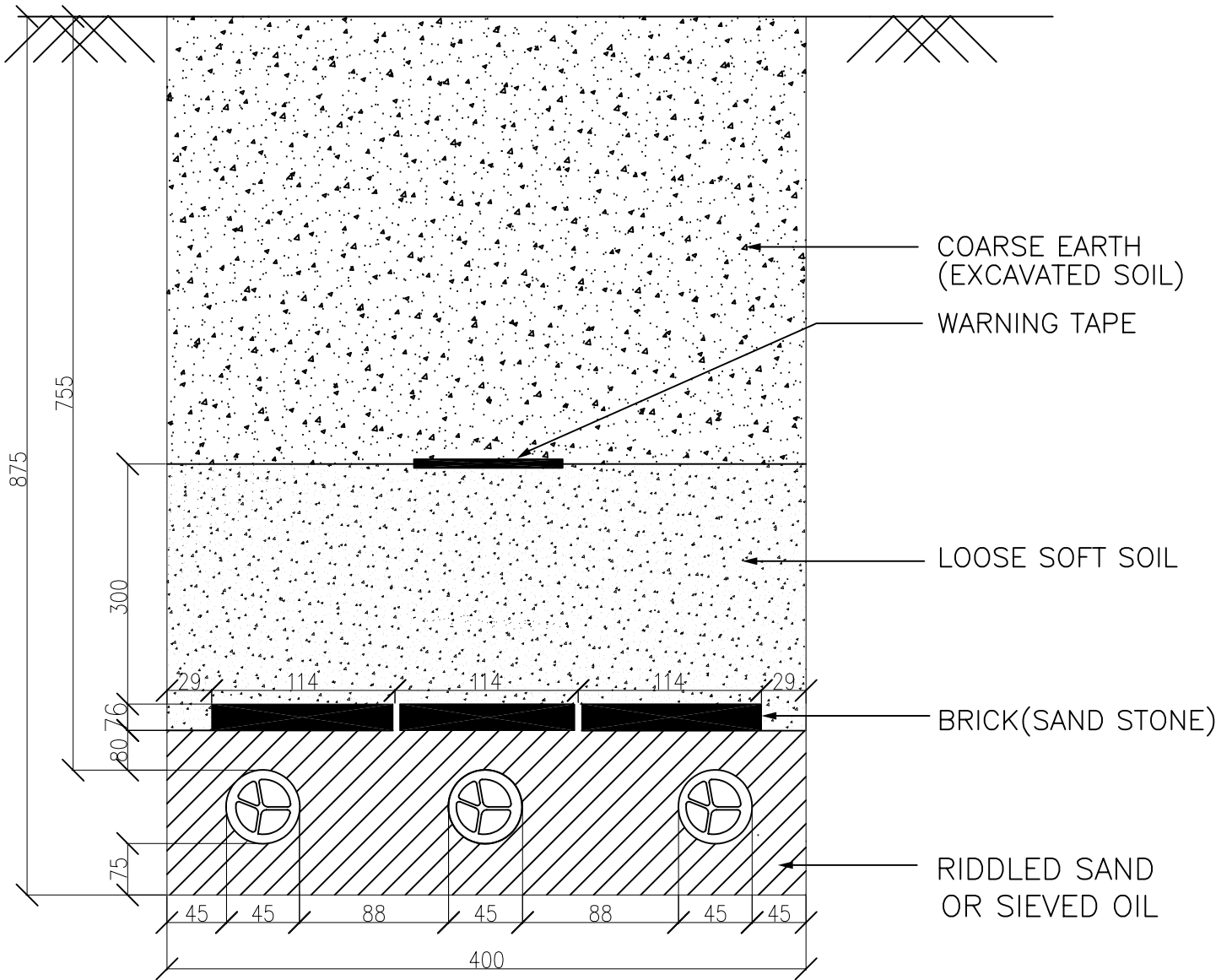

TYPICAL DETAILS FOR 1.1KV BURRIED CABLE
TYPE – A 1

DRAWN	DS	TITLE:–
CHECKED	SGD	TRENCH DRAWING FOR
APPD.	D.GUHA	3.5Cx150Sqmm 1.1 KV
DATE		XLPE CABLE
SCALE		

BSES

REV.
00

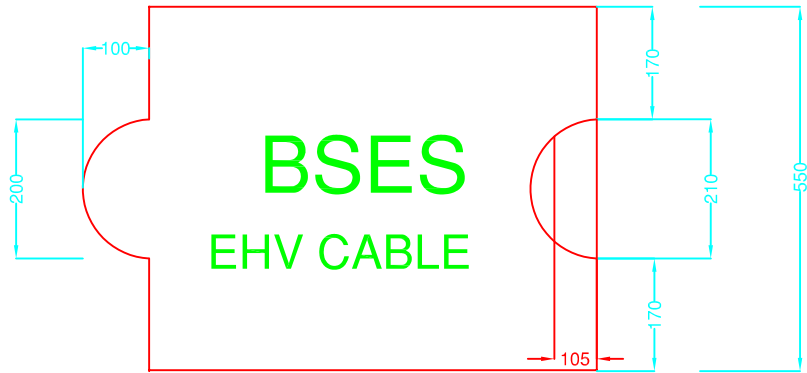

PLAN



ELEVATION

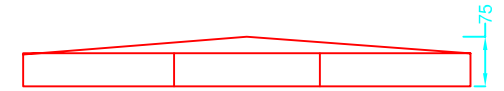

SIDE VIEW

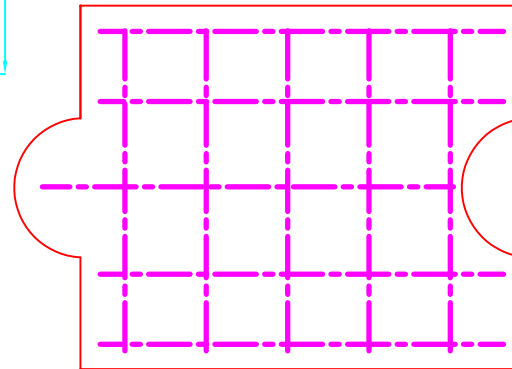

CABLE COVER FOR EHV CABLES TYPE - A.

NOTE -

- (i) All dimensions are in MM.
- (ii) Concrete Mix 1 : 2 : 4
- (iii) MS rod - 6 MM Ø

1. STEEL ROD - AS PER IS 432/1139
2. CONCRETE MIX SHALL BE NOT LESS THAN M200 GRADE AS PER IS 456.
3. MOULDING SHALL BE WITH COMPACTION NOT LESS THAN 7 MN/Sq.m.(70 kgf/Sqcm)

DRAWN		TITLE:-	BSES
CHECKED		CABLE COVER	
APPD.		FOR EHV CABLE	
DATE		TYPE - A	
SCALE			
			REV. 00



PLAN

1. STEEL ROD - AS PER IS 432/1139
2. CONCRETE MIX SHALL BE NOT LESS THAN M200 GRADE AS PER IS 456.
3. MOULDING SHALL BE WITH COMPACTION NOT LESS THAN 7 MN/Sq.m.(70 kgf/Sqcm)



ELEVATION



SIDE VIEW

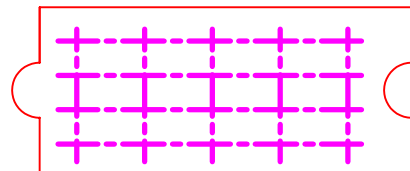

NOTE -

- (i) All dimensions are in MM.
- (ii) Concrete Mix 1 : 2 : 4
- (iii) MS rod - 6 MM Ø

CABLE COVER FOR EHV CABLES TYPE B.

DRAWN		TITLE:--	BSES
CHECKED		CABLE COVER FOR EHV CABLES TYPE - B	
APPD.			
DATE			
SCALE			

Annexure-7: Barricading and Safety

1. Dimensions of barricading- Height- 2 mtr, Length- 1.5 mtr. Refer drawing enclosed with tech spec for more details.
2. There shall not have any gap in between two barricades. Edge to edge shall be intact.
3. LED Bacon light shall be placed at 1st and 4th barricade and same shall be continue
4. Name, painting, colour, clean ness etc. shall be done on regular basis.
5. Vendor to ensure that traffic management shall not be excuse of work execution. The contactor shall not undertake loading and unloading at carriageways obstructing the free flow of vehicular traffic and encroachment of existing roads by the contactor applying the excuse of work execution.
6. Full height fence, barriers, barricades etc. shall be erected around the site in order to prevent the working area from the risk of accidents due to speedy vehicular movement. Same the way barricades protect the road users from the danger due to construction equipment and temporary structures.
7. The structure dimensions of the barricades , material and composition, its colour scheme, BSES logo and details shall be in accordance with specification and drawing laid down in the tender documents.
8. All the barricades shall be erected as per the design requirements of employer, numbered painted and maintained in good condition and also barricade in charge maintain a barricade register at site
9. All barricades shall be conspicuously seen in the dark/night time by the road users so that no vehicle hits the barricades. Conspicuity shall be ensured by affixing retro reflective strips of required size and shape at appropriate angle at bottom and middle portion of the barricades at a minimum gap of 1000 mm. In addition minimum one red light /red blinker and red beacon light should be placed at the top of each barricade.
10. No dust deposit at the front side of barricades.
11. Cable drum shall be returnable and vendor shall take it back (by bye back process) from site at their own risk and cost.
12. Once cable lying complete of a drum, within two days empty drum shall be removed from site by bye back process.
13. Trained traffic marshal with all PPE and traffic control light (Red and Green) shall be placed at site for 24x7.
14. No excuse of theft (beyond 6 hrs. of FIR) shall be acceptable.
15. During execution of job, any damage to other agency's properties shall be counted in vendor account and necessary action shall be taken by vendor to recover, repair etc.
16. Excess earth shall be removed from site after back filling. Site to be cleared to avoid flowing of dust. Barricades to be removed from site with in 24 hrs. after completion of job.
17. During non working hrs. vendor to ensure presence of supervisor for controlling any event from locals.
18. PPEs
 - Helmets

- Mask
- Jacket
- Shoes
- First Aid Box etc.

Shall be available at site 24x7. Zero tolerance on absence of PPEs to the working personnel. No excuse shall be acceptable in this regards.

19. GPR/Scanning shall be done by vendor of whole the route and same shall be submitted to BRPL. This work shall be done by vendor before execution of job.
20. Jointing TAT- Jointing to start within 48 hrs. and shall be completed by 96 hrs.+1 day.
21. Lifting of cable drums with hydraulic machine, pulling of cable from top end of drum with pulling machine (hydraulic winch) is mandatory.
22. Violation on barricading guideline and safety norms, a fine of Rs.5000 /day shall be imposed. BRPL inspector/engineer in-charge shall be empowered to impose the above penalty.

Annexure # 8 – ROUTE MARKER AND BARRICADING DRAWING

DETAIL OF HT CABLE ROUTE
MARKER (RCC) - BSES

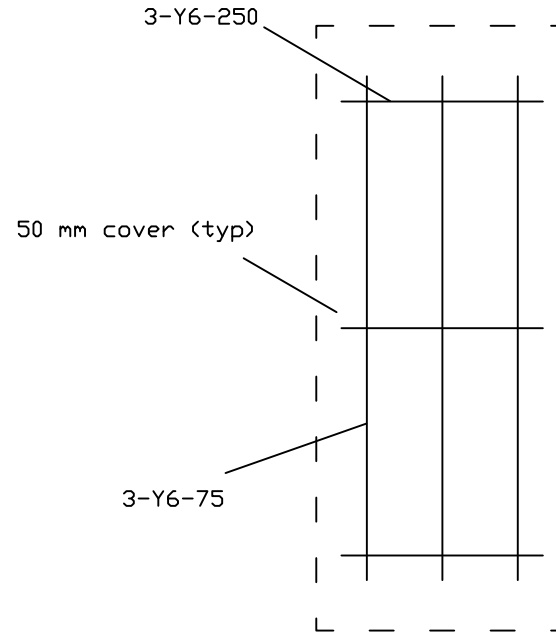
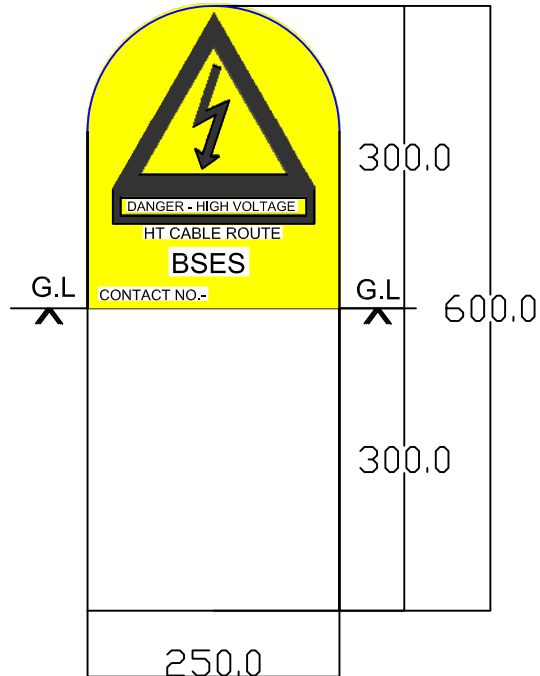

Notes:-

1	RCC Cable route marker with 6 mm Dia. Road and M25 concrete grade.
2	The litter/number shall be engraved on both the side route marker.
3	All dimensions are in mm unless specified.
4	Thickness of RCC shall be 75mm.
5	Yellow colour shall be visible above ground level.
6	Each route marker to be placed at an interval 50 mtr. and at every turn of route.
7	All kind of paint on route marker shall be in the scope of manufacturer.

DRAWN	R.K.JANA	TITLE:- DETAIL OF HT CABLE ROUTE MAKER (RCC).	BSES BSES Rajdhani Power Ltd.
CHECKED	P.B		
REVIEWED	M.B		
APPO.	K.A		
DATE	16.08.16		
			DWG. NO. BSES-RM-RCC-01, R0

BARRICADING FOR CABLE LAYING WORK

NOTE:

1. Barricading shall provided through out the route length as well as project location.
2. Plate shall be MS
3. Supervisour name, ph no, work in progress, shall be mentioned at every 1st and 4th plate of barricading through out the route.
4. Becon Light shall be provided through out the length.
5. Traffic marshal shall be Provided for traffic control by vendor.
6. Violation of safety norms and barricading shall be reviewed by BRPL and shall impose fine of Rs.5000/day as well as termination of work and short close of award.
7. After finishing of job vendor shall take return all the plate at their own risk and cost.
8. PPE's like Helmet, Mask, Jacket, safety boot etc. shall be provided vendor to all worker.

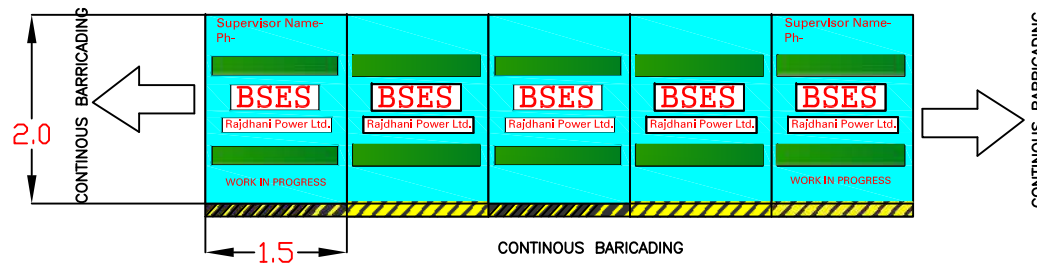
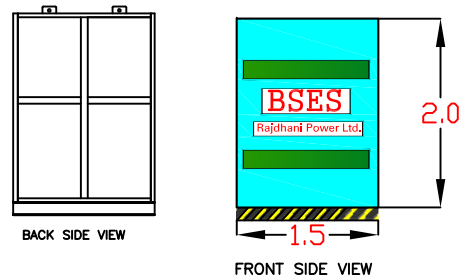

DRAWN	R.K.JANA	TITLE:--	 BSES Rajdhani Power Limited
CHECKED	P.B.	DRAWING-BARRICADING FOR CABLE LAYING WORK	
REVIEWED	A.S.		
APPD.	V.P.		
DATE	29.06.17		

Annexure#9-Note for HDPE Pipe Diameter in Cable Laying

- 1) Primarily our intent for laying cable will be through open trench only.
- 2) Trench dimensions shall be as per the standards which mentioned as below table

Sl. no.	Cable	Trench Details (mm)		
		Depth (single and double run)	Width (Single Run)	Width (Double Run)
1	LT Cable	875	400	400
2	11 kv	1055	400	650
3	33 kv	1235	400	650
4	66 Kv	1445	650	1200

- 3) QC team will do stage inspection after completion of digging to validate the depth of trench and will give approval for issuing of cable.
- 4) Execution in charge to ensure the cable laying work.
- 5) QC team will also inspection the laying work to validate the laying as per standards before back filling.
- 6) In case of site constraints, trench less cable laying shall be allowed as per the followings-
 - a) Cable laying up to 50 mtr through trenchless will be allowed with approval of circle head (O&M) for road crossing or site constraints. Site photos of constraints shall be reviewed before approval by circle head.
 - b) Absence of permission for digging- written disapproval by road owing agency and appropriate approval by circle head (for O&M Jobs), by O&M head (for 11kV, P&C job) and by EHV head (for EHV Jobs)
 - c) The size of HDPE (PN6, PE80) pipe shall be as per the guidelines of IS-1255, 1983, clause no-6.3.4.3. Details mentioned below in below table-

Sl. No	Cable	Recommended Dia of HDPE pipe (mm)
1	66kV, 3CX300	225
2	66kV, 1CX630	180
3	66kV, 1CX1000	180
4	33kV, 3CX400	180
5	11kV, 3CX300	160
6	11kV, 3CX150	160

- d) In-case of using lower size of HDPE pipe due to site conditions, the deviation for using lower HDPE pipe from above table, written approval must be taken through technical committee. Photos of the challenges while apparently the same will be reviewed by technical committee.

(However, HDPE pipe size with less than 1.5XOD of cable shall not be allowed at any stage)

BSES

Technical Specification

for

Drawings of Miscellaneous RCC Hardware Items

Specification no – BSES-TS-59-RCCH-R0

Rev:	0	
Date:	17 May 2022	
Pages:	6	
Prepared by	Akhilesh Chaudhary	<i>Akhilesh</i>
	Gautam Deka	<i>Gautam</i>
Reviewed by	Srinivas Gopu	<i>Srinivas</i>
	Amit Tomar	<i>Amit</i>
Approved by	Gaurav Sharma	<i>Gaurav</i>
	Gopal Nariya	<i>Gopal</i>

DETAIL OF HIGH VOLTAGE CABLE ROUTE MARKER (RCC) -BSES

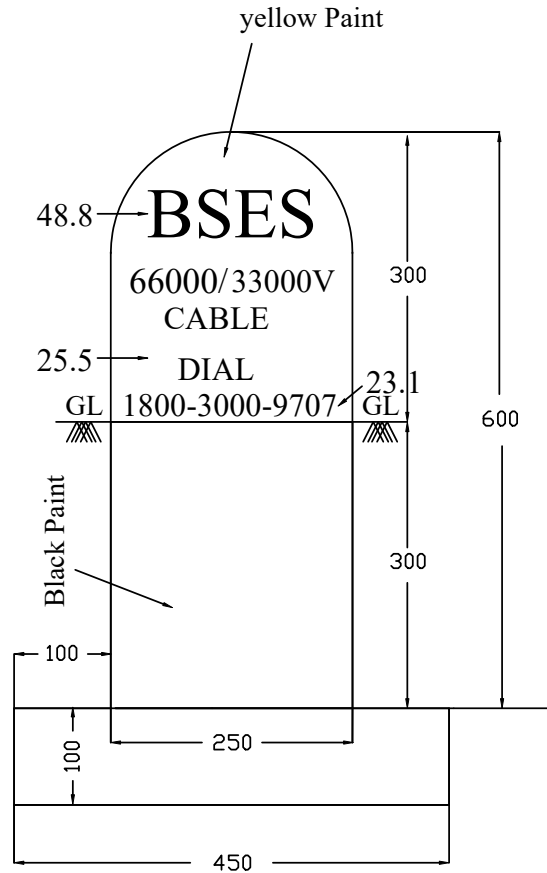

Reinforcement Detail

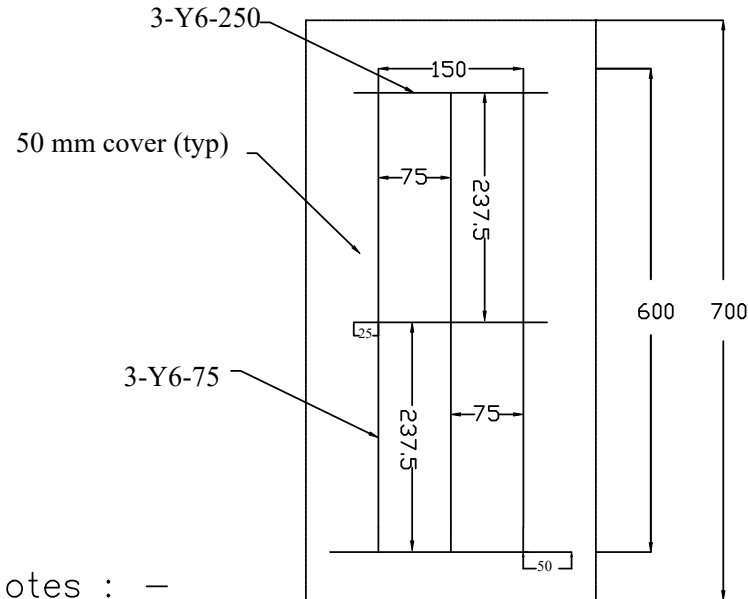

Notes : -

1	RCC cable route marker with 6mm Dia Rod and M25 concrete grade.
2	All the details shall be emgraved on both the sides of route maker
3	All dimentions are in mm, unless specified.
4	Thickness of RCC shall be 75mm.
5	Yellow colour shall be visible about ground level.
6	Eachcable joint marker to be placed at cable joints.
7	All kind of point on route marker shall be in the scope of manufacturer.
8	RCC Marker shall be painted with "Texture Paint" & quality shall be maintainted.

Title : -

DETAIL OF HIGH
VOLTAGE CABLE
ROUTE MARKER
(RCC)

BSES

DWG. NO.

BSES-RM-RCC-01,R0

50MM THK RCC PLATE

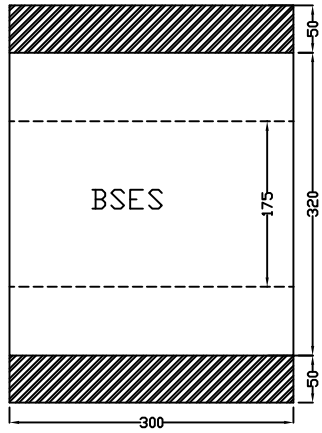

A. PLAN

4 NOS.
6MM DIA BARS

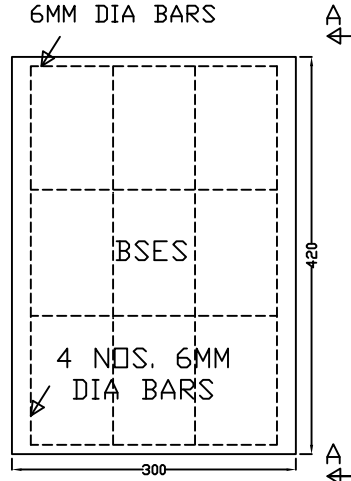

B. REINFORCEMENT DETAILS
300MM LENTH RCC PLATE

4 NOS.
6MM DIA BARS

2 NOS.
6MM DIA BARS

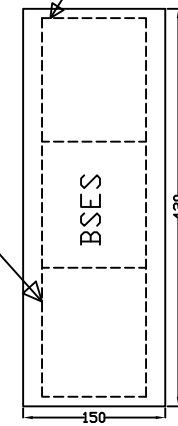

C. REINFORCEMENT DETAILS
150MM LENTH RCC PLATE

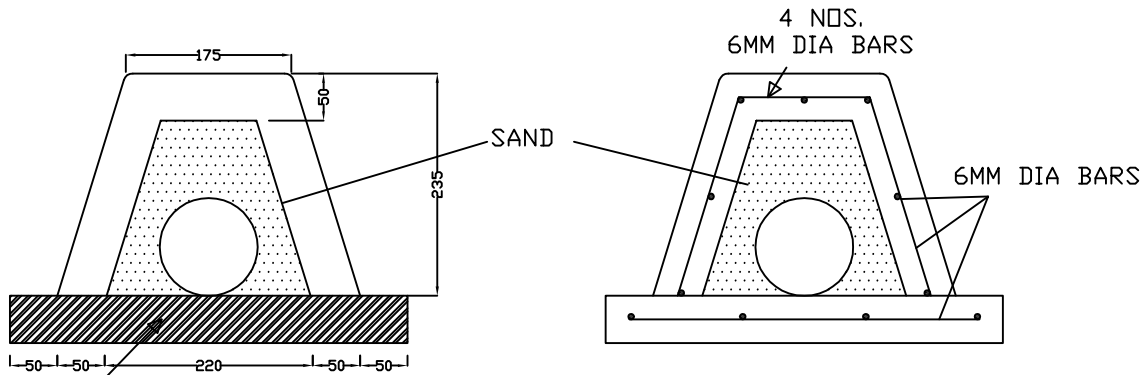

D. ELEVATION

E. REINFORCEMENT DETAILS

NOTE-

1. ALL DIMENSIONS ARE IN MM
2. CONCRETE MIX 1: 1.5: 3
3. STEEL TMT/RIB BAR 6MM DIA AS PER IS 432/1139
4. CONCRETE MIX SHALL BE NOT LESS THAN M20 /1: 1.5: 3 GRADE AS PER IS 456
5. MOULDING SHALL BE WITH COMPACTION NOT LESS THAN 7N/MMSQ (70 KGF/SQCM)
6. REINFORCEMENT DETAIL AS PER IS 5820/IS 456
7. COVER- 20MM

DRAWING OF CABLE COVER AT CABLE JOINTS

DRAWN	RAJESH	BSES BSES Yamuna Power Limited
CHECKED	S.G	
APPD.	G.S	
DATE	12.04.22	TITLE:-
SCALE	NTS	DRAWING OF CABLE COVER AT CABLE JOINTS

RCC BASE PLATE SIZE 450X450X50mm

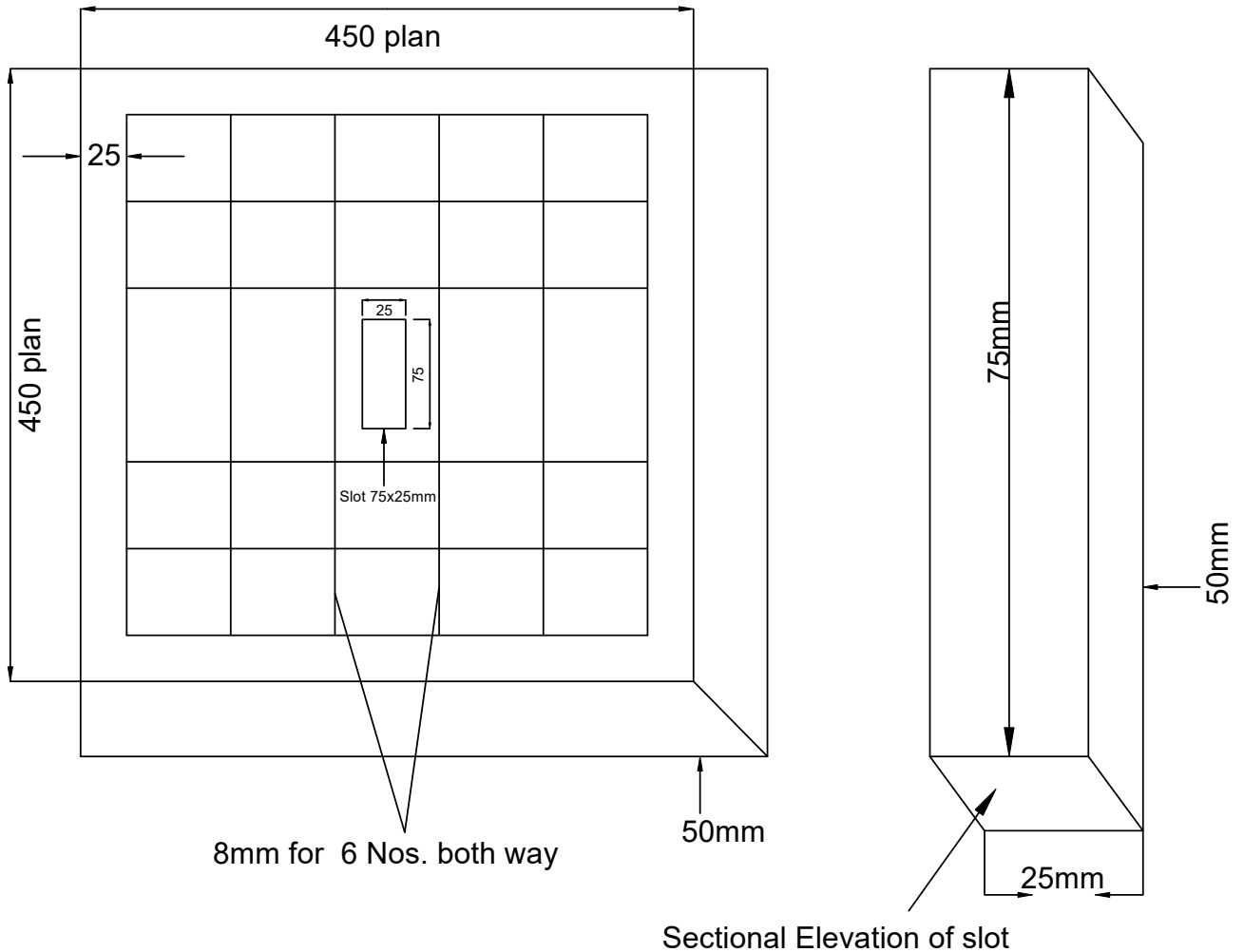

NOTES :-

1. Nominal Mix of concrete 1:2:4:M:20
2. Reinforcement shall be welded / Binded at Junctions.
3. Reinforcement :- 8mm dia for 6 nos. each side.
4. IS AND ITS LATEST AMMENDMENTS SHALL BE APPLICABLE.

TITLE :-

**RCC BASE
PLATE**

BSES

DRAWING NO.

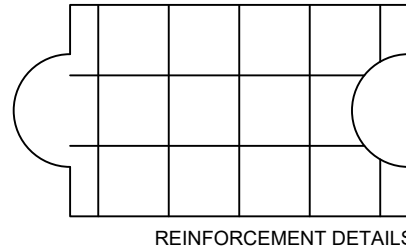
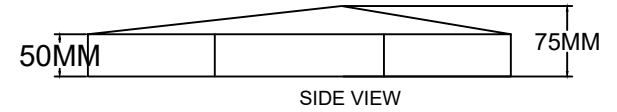
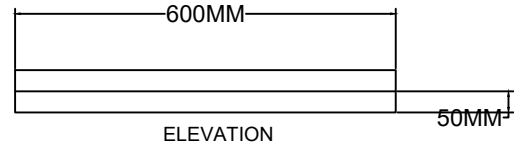
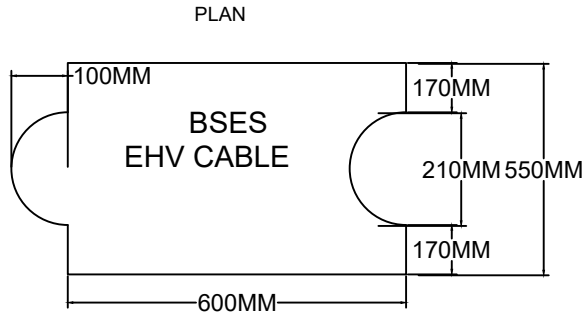

NOTES:-

1. ALL DIMENSIONS ARE IN MM
2. CONCRETE MIX 1:2:4
3. MS ROD -6MM \varnothing
4. STEEL ROD -AS PER IS 423/1139

OWNER- BSES

TITLE-CABLE COVER (SLAB)

DATE-13.04.2022

DRAWN BY

CHECKED BY

APPROVED BY

DRAWING OF COFFIN FOR JOINTS

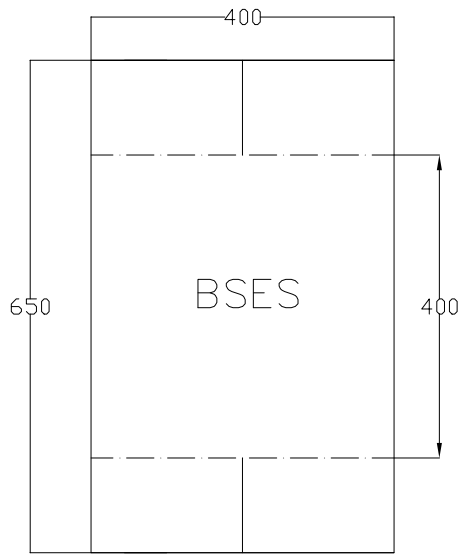

A. PLAN

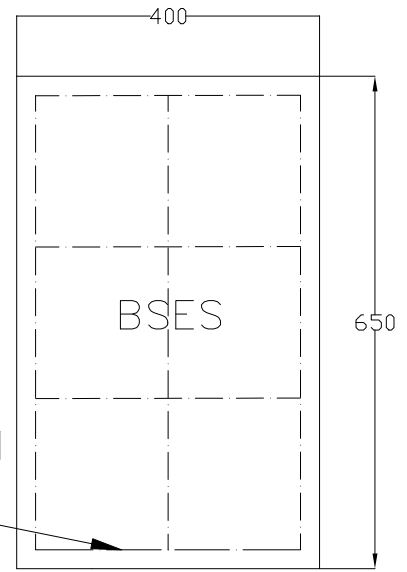

B. REINFORCEMENT
DETAILS 300 MM
LENGTH RCC PLATE

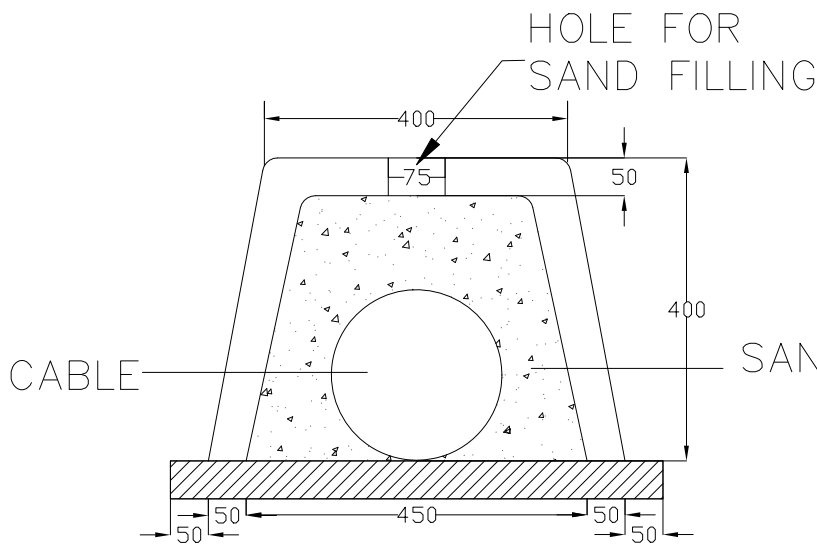

D. ELEVATION

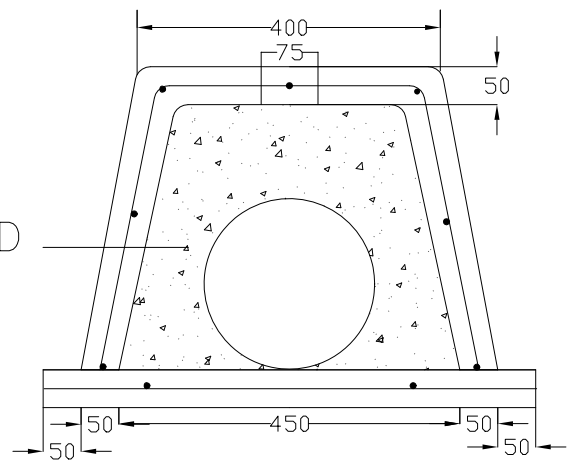

E. REINFORCEMENT
DETAILS

NOTES :-

1. ALL DIMENSIONS ARE IN MM
2. CONCRETE MIX 1:1.5:3

TITLE :-

DRAWING OF COFFIN
COVER AT CABLE
JOINTS

BSES

DRAWING NO.

48F Composite Fiber Multitube (MDPE) Single Sheath Duct Lite Optical Fiber Cable

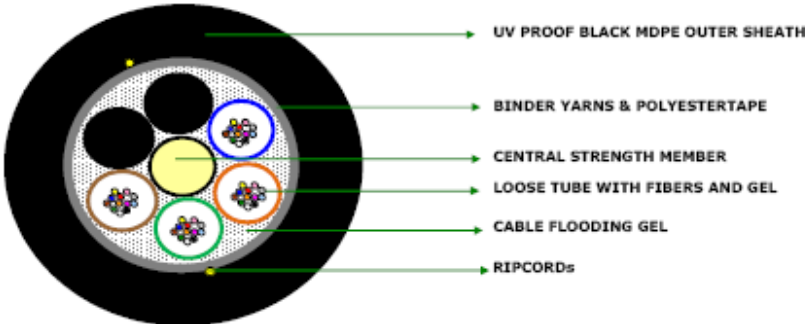
PRODUCT INFORMATION			
Fiber			
Single Mode Optical Fiber	36 Nos.	Fiber ITU.T - G.657A1	
Maximum Cabled Fiber Attenuation dB/Km		1310nm : 0.36 & 1550nm : 0.23 & 1625nm : 0.26	
Multi Mode Optical Fiber	12 Nos.	Fiber OM2 : 50/125	
Maximum Cabled Fiber Attenuation dB/Km		8500nm : 3.5 & 1300nm : 1.5	
Loose Tube			
Filling Gel		Thixotropic gel to prevent water ingress in loose tube (ITCO T 250)	
Fiber Per Tube	12 Nos.		
Tube	4 Nos.	Thermoplastic Material (PBT)	
Core			
Central Strength Member		Fibre Reinforced Plastic (FRP) to provide tensile strength and antibuckling properties.	
Filler	2 Nos.	Polyethylene Black	
Water blocking elements		Cable flooding gel is added in interstices of core to prevent water ingress in the cable core (ITCO C 480)	
Core Covering		Binder and Polyester Tape	
Cable			
Rip Cord	2 Nos.	Polyester Based Twisted Yarn	Applied below Outer Sheath
Outer Sheathing		UV Proof Black MDPE (ME 6052/ME 6056)	2.2 mm Nominal Thickness
CONSTRUCTIONAL DETAILS			
			
Typical construction Diagram - Not to Scale			
OPTICAL FIBER CABLE PERFORMANCE			
MECHANICAL		ENVIRONMENTAL	
Max. Tensile strength	2500 N	Crush Resistance	2000 N / 100x100 mm
Minimum Bend Radius	20 D	Impact strength	25 Nm.
Repeated Bending Test	20 D,30Cycle	Torsion	≅180°
Water Penetration	1m head, 3m samples, 24 Hr		Drip Test
			30 cm, 70°C, 24 hr
<i>Tests shall be carried out as per IEC 60793 & IEC 60794-1-2/GR 20 Standards. Change in attenuations shall be ≤ 0.05 dB.</i>			
COLOR DETAILS			
Optical Fibre Colour	Blue, Orange, Green, Brown, Slate, White, Red, Black, Yellow, Violet, Pink, Aqua.		
Loose Tube Colour	For G657A1 : Blue, Orange, Green & For OM2 : Brown.		
Outer Sheath Colour	Black		
PHYSICAL PARAMETERS			
Cable Diameter (mm)	11.75 ± 0.25	Cable Wt. (Kg/Km)	114 ± 10%
		Cable Length:	2 Km ± 5%
PRINTING DETAILS			
Cable Printing details (White - Hot Foil Emb.)	48F TELEPHONE SYMBOL LASER SYMBOL MONTH & YEAR OF MANUFACTURE LENGTH CODE METER MARKING		
<i>The accuracy of marking shall be ± 0.5%. Occasional loss of printing & remarking shall be as per Bell core GR 20 and this supercedes the earlier markings.</i>			

BSES

TECHNICAL SPECIFICATION FOR RFID ACTIVE & PASSIVE BALL / RING

Specification No: GN101-03-SP-148-00

BSES RAJDHANI POWER LTD

Prepared By	Abhay Gupta	<i>Abhay Gupta</i> 05/11/18	R0
	Pronab Bairagi	<i>Pronab Bairagi</i> 05/11/18	
Reviewed By	Amit Tomar	<i>Amit Tomar</i> 05-11-18	2-Nov-18
Approved By	K. Sheshadri	<i>K. Sheshadri</i> 05/11/18	Page 1 of 13

Registered Office: BSES Bhawan, Nehru Place, Delhi - 110019

BSES**BSES Rajdhani Power Ltd****GN101-03-SP-148-00****TECHNICAL SPECIFICATIONS OF RFID ACTIVE & PASSIVE BALL / RING****CONTENTS**

REVISION RECORD	3
1. SCOPE	4
2. CLIMATIC CONDITIONS.....	4
3. GENERAL TECHNICAL REQUIREMENT.....	5
3.1 ACTIVE BALL / RING.....	5
3.2 PASSIVE BALL / RING	7
4. INSTALLATION OF BALL / RING.....	7
4.1 CABLE TRENCH DETAILS.....	8
5. GUARANTEE PERIOD.....	9
6. TESTS.....	9
6.1 ACCEPTANCE TESTS RFID ACTIVE BALL.....	9
6.2 ACCEPTANCE TESTS RFID PASSIVE BALL.....	10
7. INSPECTION	10
8. DOCUMENTATION.....	11
8.1 DRAWING, DATA AND MANUALS	11
8.2 DOCUMENTS TO BE SUBMITTED ALONG WITH BID FOR TECHNICAL JUSTIFICATION	11
9. DELIVERY SCHEDULE.....	13
10. DEVIATION.....	13



BSES Rajdhani Power Ltd

GN101-03-SP-148-00

TECHNICAL SPECIFICATIONS OF RFID ACTIVE & PASSIVE BALL / RING

REVISION RECORD

Rev. No.	Revision Date	Item/ clause no:	Page No.	Nature of Change	Approved by



BSES Rajdhani Power Ltd

GN101-03-SP-148-00

TECHNICAL SPECIFICATIONS OF RFID ACTIVE & PASSIVE BALL / RING

1. SCOPE

The specification provides technical requirements and usage of RFID Active & Passive Ball / Ring. It shall be traced with a portable route tracer device specified herein to quickly pinpoint the location of buried facilities like cable runs, cable joints, splices, vaults, conduits etc. during the construction, installation or maintenance work across BSES Rajdhani Power Ltd, network, New Delhi.

The portable route tracer device shall be able to find the location of ball / ring and define the place and depth's position. In addition, the RFID route tracer device shall have the capability to save RFID serial number of Ball / Ring being installed on site during installation with an inbuilt GPS module that should allow the RFID route tracer to allow navigation back to the RFID route tracer.

2. CLIMATIC CONDITIONS

2.1	Average grade atmospheric condition	Heavily polluted, dry
2.2	Maximum altitude above sea level	1000m
2.3	Ambient Air temperature	Highest : 50°C Average: 30°C Minimum : 0°C
2.4	Relative Humidity	100% max
2.5	Thermal resistivity of soil	150°C cm/W (max)
2.6	Seismic Zone	4
2.7	Rainfall	750mm concentrated in four months



BSES Rajdhani Power Ltd

GN101-03-SP-148-00

TECHNICAL SPECIFICATIONS OF RFID ACTIVE & PASSIVE BALL / RING

3. GENERAL TECHNICAL REQUIREMENT

- Every RFID ball / ring shall have a unique Hexadecimal code
- The data fed in the active electronic ball / ring shall be accessible from computer and mobile from anywhere which can be saved in the computer or mobile also
- The identification code of passive electronic ball/ring shall be accessible from computer and mobile from anywhere which can be saved in computer and mobile also
- While assessing the data of RFID active ball/ring from computer or mobile, the user shall be able to-
 - See the location of the electronic Ball / Ring
 - See the Hexadecimal code of the electronic Ball / Ring
 - Shall be able to see the Ball / Ring and feeder details
 - Further details shall be as per Clause 4.1 of this technical specification
- The ball / ring shall be detectable if placed horizontally / vertically or at any angle inside the ground
- The Route Tracer (with GPS module) shall have USB accessibility to allow data transfer to computer/mobile
- Google mapping facility of feeder by using active and passive RFID ring/ball.

3.1 ACTIVE BALL / RING

- The Active Ball / Ring shall have facility to feed data by tracer or by computer/mobile as per the BRPL requirement.
- Following are the technical requirements of the active ball / ring-

S. No	Specification	BRPL Requirement
1	Data Storage	Ability to write, read and lock programmed information into the Ball / Ring using locator or by computer/mobile for accessing feeder information.



BSES Rajdhani Power Ltd

GN101-03-SP-148-00

TECHNICAL SPECIFICATIONS OF RFID ACTIVE & PASSIVE BALL / RING

S. No	Specification	BRPL Requirement
2	Data	Below data shall be feed inside the active Ball / Ring or locator- <ul style="list-style-type: none">• BRPL Vendor Name Feeder Details• BRPL site supervisor Vendor's supervisor at site• Jointing details – Make of jointing kit Cable grade and type Joint type• PO No. of jointing kit• Date of installation of ball Joints name
3	Design and shape	Ball / Ring
4	Free floating coil	Free floating coil for self leveling, horizontal position (floating coil will always be horizontal and provide accurate location of joint)/ Ring capable of being detectable from all directions.
5	Temperature effect	Non freezing fluid/ Other
7	Material	Made of High dense plastic
8	Frequency range	169.8 kHz standard / As per manufacturer's standard for power utility
9	Colour	Red/orange
10	Diameter	Outer Dia- 150mm max for ball, 250 mm for ring
11	Minimum Depth range	As per the table mentioned in the clause 4.1
12	Weight	0.4 kg max for both ring and ball
13	Power Source	Self generated, no batteries required for signal transmission

TECHNICAL SPECIFICATIONS OF RFID ACTIVE & PASSIVE BALL / RING**3.2 PASSIVE BALL / RING**

The Passive ball / Rings shall be buried at every 50m on the cable route from the point of starting of circuit.

Following are the technical requirements-

S. No	Specification	BRPL Requirement
1	Design and Shape	Ball / Ring
2	Free Floating Coil	Free floating coil for self leveling, horizontal position (floating coil will always be horizontal and provide accurate location of cable route)/ Or ring coil should be detectable from all direction.
3	Temperature effect	Non freezing liquid/ Other
4	Application	To trace cable route
5	Material	Made of high density plastic
6	Frequency Range	169.8 kHz standard / As per manufacturer's standard
7	Colour	Red/orange
8	Diameter	Outer dia- 150 mm max for ball, 250 mm max for ring.
9	Depth Range	Applicable as mentioned in the clause no-4.1
10	Weight	0.4 kg for both ball and ring
11	Power Source	Self generated, no batteries required for signal transmission

4. INSTALLATION OF BALL / RING

- During Backfill of trench in which pipe or cable is being laid.
- Continue Backfilling by sand or earth

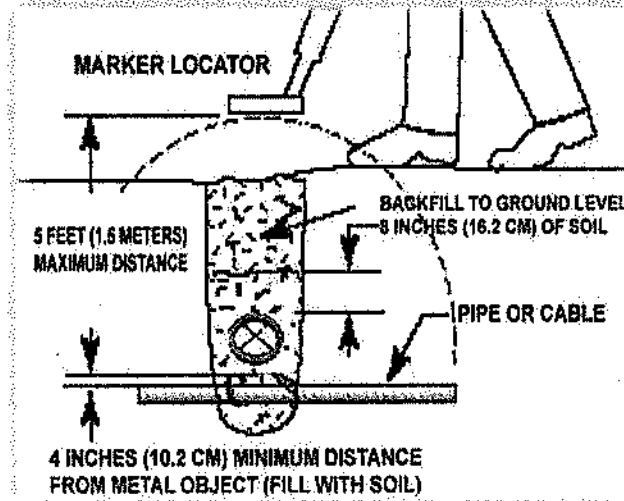
TECHNICAL SPECIFICATIONS OF RFID ACTIVE & PASSIVE BALL / RING**4.1 CABLE TRENCH DETAILS**

A	11 KV Cables	Width (mm)	Depth (mm)
a	3Cx150 / 300 mm ² - Single Circuit	400	1055
b	3Cx150 / 300 mm ² - Double Circuit	650	1055
B	33 kV Cables	Width (mm)	Depth (mm)
a	3Cx400 mm ² - Single Circuit	400	1235
b	3Cx400 mm ² - Double Circuit	650	1235
c	3Cx400 mm ² - Quadruple Circuit	650	1235
d	3Cx400 mm ² - Quadruple Circuit	650	1545
e	3Cx400 mm ² - Quadruple Circuit	1200	1235
C	66 kV Cables	Width (mm)	Depth (mm)
a	1Cx630/1000 mm ² - Single Circuit	650	1445
b	1Cx630/1000 mm ² - Double circuit	1200	1445
c	3Cx300 mm ² - Double circuit	1200	1445

BSES

BSES Rajdhani Power Ltd

GN101-03-SP-148-00

TECHNICAL SPECIFICATIONS OF RFID ACTIVE & PASSIVE BALL / RING**5. GUARANTEE PERIOD**

A guarantee period for RFID Ball / Ring of 25 years shall be provided the manufacturer.

6. TESTS**6.1 ACCEPTANCE TESTS RFID ACTIVE BALL**

Sr. no.	Specification	Manufacturer to provide	Inspection Method by BRPL
1	Data Storage	Ability to write, read and lock programmed information into the Marker	Perform
2	Design and shape	Ball shape	Visual inspection
3	Free floating Coil	a free floating Coil for self leveling, Horizontal position	Visual inspection
4	Temperature effect	Non freezing fluid	Sample shall be sealed for NABL lab testing
5	Design and Shape	Made of high dense plastic	Visual inspection
6	Frequency Range	169.8 KHz	Review of document/Test Certificates
7	Colour	Red/Orange	Visual inspection
8	Dimension	As mentioned above	Perform and Measurement
9	Depth range	As per the table mentioned in the clause no-4.1	Perform
10	Weight	As mentioned above	Perform and Measurement

BSES

BSES Rajdhani Power Ltd

GN101-03-SP-148-00

TECHNICAL SPECIFICATIONS OF RFID ACTIVE & PASSIVE BALL / RING**6.2 ACCEPTANCE TESTS RFID PASSIVE BALL**

Sr. no.	Specification	Manufacturer to provide	Inspection Method by BRPL
1	Design and shape	Ball/ring shape	Visual inspection
2	Free floating Coil	A free floating Coil for self leveling, Horizontal position	Visual inspection
3	Temperature effect	Non freezing fluid	Sample shall be sealed for NABL lab testing
4	Design and Shape	Made of high dense plastic	Visual inspection
5	Frequency Range	169.8 KHz	Review of document/Test Certificates
6	Colour	Red/Orange	Visual inspection
7	Dimension	As per the requirement	Perform and Measurement
8	Depth range	As per the table mentioned in the clause no-4.1	Perform
9	Weight	As per the requirement	Perform and Measurement

7 INSPECTION

8.1	BRPL representative shall at all times be entitled to have access to the works and all places of the manufacturer/ distributor where RFID Active / Passive ball / ring shall be manufactured and the representative shall have full facilities for unrestricted inspection of the Manufacturer's works/ distributors place, raw materials, store process and process of manufacture and conducting necessary tests as may be deemed fit, for certifying the quality of product.
-----	---



BSES Rajdhani Power Ltd

GN101-03-SP-148-00

TECHNICAL SPECIFICATIONS OF RFID ACTIVE & PASSIVE BALL / RING

8.2	The Manufacturer shall keep BRPL informed in advance of the time of starting and of the progress of manufacturing of RFID active and passive ball / ring and route tracer in its various stages so that arrangements can be made for inspection.
8.3	No material shall be dispatched from its point of manufacture and works before it has been satisfactorily inspected, tested, and necessary dispatch instructions are issued in writing, except for the cases where waiver of inspection is granted by BRPL, and even in this case also, written dispatch instructions will be issued. Any dispatches before the issue of Dispatch Instructions in writing will be liable for rejection and non acceptance by the consignee.
8.4	The acceptance of any quantity of material shall in no way relieve the Manufacturer of any of his responsibilities for meeting all requirements of the specification, and shall not prevent subsequent rejection if such material is later found to be defective.
8.5	Only soft copy of inspection report shall be furnished by manufacturer through mail. BRPL shall not receive any hard copy of report for their office record.

8. DOCUMENTATION

Submission of drawings, calculations, catalogues, manuals, test reports shall be as mentioned below:

8.1 DRAWING, DATA AND MANUALS

Cross-Sectional drawing shall show every feature of construction. This drawing shall also state the hexadecimal code to be printed on the ball / ring.

8.2 DOCUMENTS TO BE SUBMITTED ALONG WITH BID FOR TECHNICAL JUSTIFICATION

The vendor shall submit-

- Cross sectional drawing
- GTP (all data to appear)
- Type test certificates if any

Document Submission

- Submission of drawings, calculations, catalogues, manuals, test reports shall be as follows.

Legend:



BSES Rajdhani Power Ltd

GN101-03-SP-148-00

TECHNICAL SPECIFICATIONS OF RFID ACTIVE & PASSIVE BALL / RING

GTP : Guaranteed Technical Particulars
TTR : Type Test Report
RTR : Routine Test Report

	Documents Along with offer	After award of contract- for Approval	Final documents(after Approval)
GTP	1 copies	** 1 soft copy	** 1 soft copy + CD
Drawings	1 copies	** 1 soft copy	** 1 soft copy + CD
Calculations	1copies	** 1 soft copy	** 1 soft copy + CD
Catalogues & Manual	1 copy each		** 1 soft copy + CD
Test Report	1 copy each of TTR and sample RTR		** 1 soft copy + CD

** Soft copy and CD shall contain documents duly approved, signed and scanned

- The manufacturing of the RFID Ball/ Ring shall be strictly in accordance with the approved drawings and no deviation shall be permitted without the written approval of the BRPL. All manufacturing and fabrication work in connection with the RFID Ball/ Ring prior to the approval of the drawing shall be at manufacturer's risk.
- Approval of drawing etc. by the BRPL shall not relieve the Manufacturer of his responsibility and liability for ensuring correctness and correct interpretation of the latest revision of applicable standards, rules and codes of practices. The RFID Ball/ Ring shall conform in all respects to high standards of engineering, design, workmanship and latest revisions of relevant standards at the time of ordering and BRPL shall have the power to reject any work or material which in his judgment is not in full accordance therewith.



BSES Rajdhani Power Ltd

GN101-03-SP-148-00

TECHNICAL SPECIFICATIONS OF RFID ACTIVE & PASSIVE BALL / RING

9. DELIVERY SCHEDULE

- Delivery period Start Date : From date of LOI / LOA
- Delivery period End Date : As agreed with manufacturer
- Material dispatch Clearance : After inspection, shall be issued by BRPL.

10. DEVIATION

- Deviations from this specification shall be listed separately by bidder clause wise (format given below) along with optional offer and has to submit the list along with bid/quotation. BRPL will review the deviations and if BRPL is agreed with the deviation, seller has to take written confirmation from BRPL on deviation during tender evaluation.
- In the absence of any separate list of deviations from the bidders with bid as well as written confirmation from BRPL on deviations, it will be assumed by the Buyer that the Seller complies with the Specification fully.
- Any deviations mentioned in any other submitted bid documents (i.e.in filled GTP, Catalog, BRPL old approval, buyer's/seller's standards etc) by seller without separate deviation sheets will not consider as a deviation from this tech spec at any stage of contract.

Deviation sheet format—

Sino	Document Name	Clause No.	Deviation	Reason	Merits to BRPL

Specification of HDPE Pipe

- 1) Scope : Supply of HDPE pipe
- 2) Service conditions:

HDPE pipe shall be suitable to use in following Climate conditions.		
2.1	Maximum ambient temperature	50 Deg C
2.2	Relative Humidity	0 to 96%
2.3	Maximum annual rainfall	790 mm
2.4	Atmosphere	Heavily polluted, dry, dust

- 3) Cable Details:

Sl. No	Cable Details	Approx Dia of Cable (mm)
1	66kV, 3CX300	125
2	66kV, 1CX630	80.5
3	66kV, 1CX1000	93
4	33kV, 3CX400	106
5	11kV, 3CX400	83
6	11kV, 3CX300	77
7	11kV, 3CX150	61
8	1.1kV, 4CX300	60

2. Technical requirement: HDPE pipe (PN6, PE80) , Wall thickness- as per IS 4984, 2016, Colour- Black
3. Selection of HDPE pipe diameter:

Sl. No	Cable	Recommended Dia of HDPE pipe (mm)
1	66kV, 3CX300	225
2	66kV, 1CX630	180

3	66kV, 1CX1000	180
4	33kV, 3CX400	180
5	11kV, 3CX400	160
6	11kV, 3CX300	160
7	11kV, 3CX150	160
8	1.1kV, 4CX300	110

4. Type Test: Product shall be type tested as per IS 4984, 2016 from any NABL lab. Type test report shall not be older more than 5 years.
5. Acceptance Test: All acceptance test shall be followed as per IS 4984, 2016
6. Embossing as well as ink jet printing: Each pipe shall be embossed and shall be printed with below characters at 1 mtr interval
 - Manufacturer name/Trade mark
 - Customer name
 - Year and month of manufacturing
 - BIS details
 - PO no and date
 - Lot no/Batch no
 - HDPE-dia of pipe, PN6, PE80
 - Length marking
7. Length of pipe: Length of pipe shall be 5 mtr. to 20 mtr as agreed by BSES. Short length may be considered as per IS 4984 or as agreed by BSES.
8. Deviation: Bidder has to intimate to BSES for any kind of deviation and written confirmation shall be taken at evaluation stage. Without any written confirmation on deviation from BSES, it will be assumed that bidder shall comply technical specification fully.
9. Inspection: BSES reserve the right to inspect material at OEM factory. All kind of acceptance as per IS 4984 test shall be conducted by BSES. OEM to intimate inspection call to BSES at 10 days advance of scheduled date.
10. Delivery: MDCC (material dispatch clearance certificate) shall be given after successful completion of final inspection.

DRAWING OF COFFIN FOR JOINTS

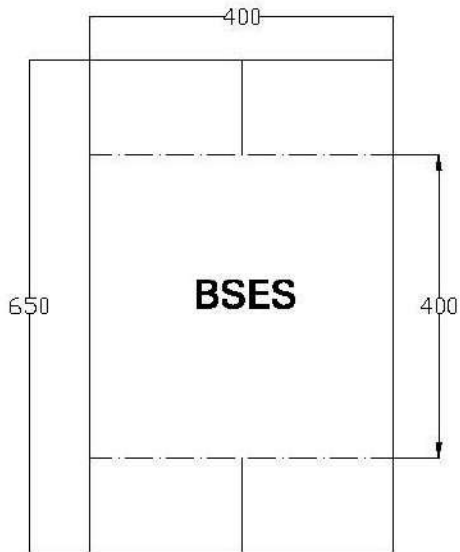

A. PLAN

3 NOS. 8MM
DIA BARS

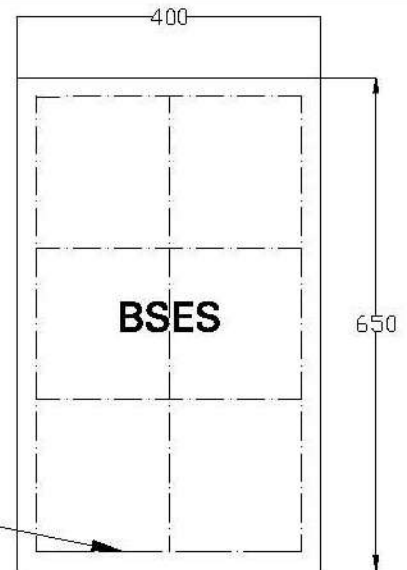

**B. REINFORCEMENT
DETAILS 300 MM**

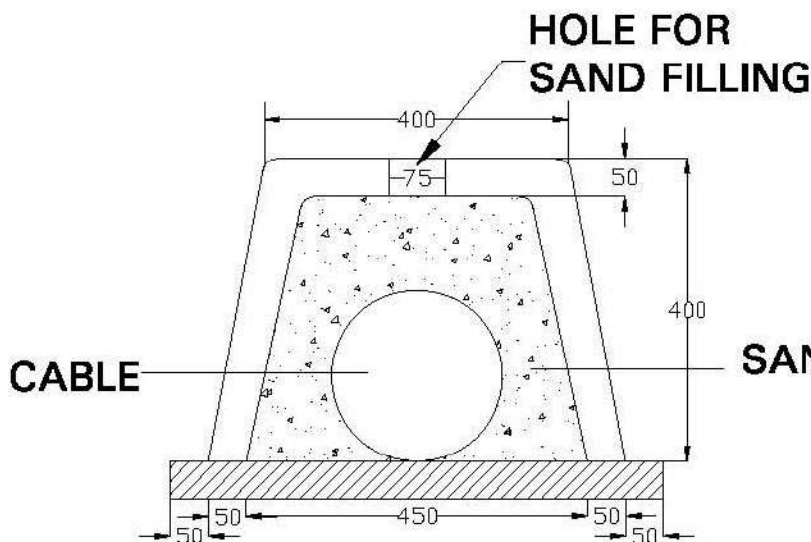

D. ELEVATION

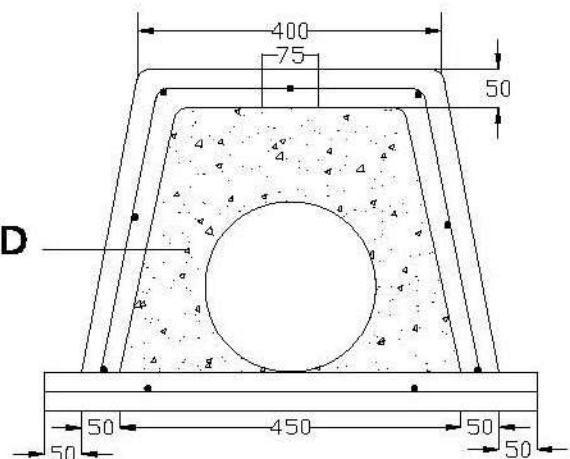

**E. REINFORCEMENT
DETAILS**

NOTES :-

1. ALL DIMENSIONS ARE IN MM
2. CONCRETE MIX 1:1.5:3
3. LENGTH OF COFFIN FOR CONSTRUCTIONAL PURPOSE ONLY. ONE COFFIN SHOULD COVER ENTIRE LENGTH OF JOINT

DRAWN	SUMIT
CHECKED	ABHAY
REVIWED	A.T
APPD.	V.P
DATE	30.01.18

TITLE :-

**DRAWING OF COFFIN
COVER AT CABLE
JOINTS**

BSES

BSES Rajdhani Power Limited

DRAWING NO.

BSES

Technical Specification of Various Types of Structural Steel Items

Specification no – BSES-TS-17-SSI-R0

Rev:	0	
Date:	05 Apr 2022	
Pages:	07	
Prepared by	Jeena Borana	<i>Jeena</i>
	Vani Sood/ Pronab Bairagi	<i>Vani Sood</i> 05/04/22 <i>Pronab</i> 05/04/22
Reviewed by	Srinivas Gopu	<i>Srinivas</i>
	Amit Tomar	<i>Amit</i> 05/04/22
Approved by	Gaurav Sharma	<i>Gaurav</i>
	K. Sheshadri	<i>K. Sheshadri</i> 05/04/22

INDEX

1.0 SCOPE OF SUPPLY	3
2.0 SERVICE CONDITION	3
3.0 CODES & STANDARDS	3
4.0 ELECTRICAL DATA	4
5.0 DESIGN PARAMETERS	4
6.0 MATERIAL	5
7.0 TESTING & INSPECTION	5
8.0 MARKING	6
9.0 DEVIATION	6
10.0 GUARANTEE CERTIFICATE.....	6
11.0 DOCUMENTS SUBMISSION	6

Technical Specification of Various Types Of Structural Steel Items**1.0 SCOPE OF SUPPLY**

The specification covers design, manufacturing, testing of structural steel items at manufacturers works before dispatch. Packing, delivery of material and submission of documents/test reports to purchaser.

2.0 SERVICE CONDITION

Structural Steel items to be supplied against this specification shall be suitable for satisfactory continuous operation under outdoor environment. Following are the climatic condition:

S. No.	Parameters	Requirements
2.1	Peak ambient temp.	55°C
2.2	Min ambient temp. in shade	45°C
2.3	Max.average ambient temp in 24 hours period in shade	40°C
2.4	Min ambient temp.	(-)5°C
2.5	Max. temp. attainable by an object exposed to sun	70°C
2.6	Max. relative humidity	95%
2.7	Average number of thunder storm days per annum	40
2.8	Average number of rainy storm days per annum	120
2.9	Average annual rainfall	1250mm
2.10	No of months of tropical monsoon condition	4 months
2.11	Max. wind pressure	150kg/m ²
2.12	Altitudes	Not exceeding 1000mtrs

3.0 CODES & STANDARDS

S. No.	Code	Description
3.1	2629.1985	Important guidelines for general for general hot-dip galvanizing of iron and steel
3.2	IS 2062	Hot Rolled Medium and High Tensile Structural Steel
3.3	IS 808	Dimension for Hot Rolled Steel Beam, Column, Channel and Angle Section
3.4	IS : 5561-1970	Specification for electric power connection

Technical Specification of Various Types Of Structural Steel Items**4.0 ELECTRICAL DATA**

S.No.	Parameters	Details
4.1	LT Supply System	3 phase AC, 4 Wire
4.2	Rated Voltage	415+/-10%
4.3	Rated Frequency	50Hz \pm 5%
4.4	Fault level	35MVA – 50kA

5.0 DESIGN PARAMETERS

S. No.	Description
5.1	MS Angle, Strctl, 50mm , 50mm , 6mm
5.2	MS Angle, Strctl, 65mm , 65mm , 6mm
5.3	MS Angle, Strctl, 75mm , 75mm , 6mm
5.4	CHNL, Strctl, ISMC; 150MM; 75MM; 16.8KG/M
5.5	CHNL, Strctl, ISMC100; 100MM; 50mm; 7.7mm
5.6	Flat, Strctl, 8mm; 50mm; 6000mm
5.7	Flat, Strctl, 6mm; 50mm; 6000mm
5.8	Flat, Strctl, 6mm; 50mm; 5500mm

5.1 MS Angle (50MM:50MM:6MM): Dimension shall be A =50mm, B=50mm, C=6mm

5.2 MS Angle (65MM:65MM:6MM): Dimension shall be A =65mm, B=65mm, C=6mm

5.3 MS Angle (75MM:75MM:6MM): Dimension shall be A =75mm, B=75mm, C=6mm

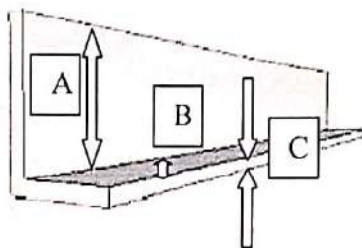

For MS Angle reference drawing (a, b & c)

Technical Specification of Various Types Of Structural Steel Items

- 5.4 Channel Structural (150MM;75MM;16.8KG/M): Dimension shall be 150MM;75MM;16.8KG/M
- 5.5 MS Channel (100MM;100MM;5MMX7.7MM): Dimension shall be D=100, B=100,t=5,T=7.7mm

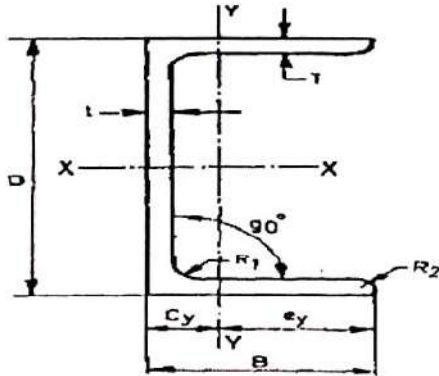

For MS Channel reference drawing (g & h)

- 5.6 Flat Structural (8MM;50MM;6000MM) : Dimension shall be 8MM;50MM;6000MM
- 5.7 Flat Structural (6MM;50MM;6000MM) : Dimension shall be 6MM;50MM;6000MM
- 5.8 Flat Structural (6MM;50MM;5500MM) : Dimension shall be 6MM;50MM;5500MM

6.0 MATERIAL

6.1	Material	Material shall be mild steel, grade 'A', Designation E-250 as per IS 2062.
6.2	Make	Steel shall be of TATA/SAIL/ESSAR/RINL/JSPL/JSW/VISA steel/Bhushan Steel/Other BSES approved make

7.0 TESTING & INSPECTION

All the tests shall be carried out in accordance with IEC / IS standards.

7.1	Visual Check	Material shall be visually checked and shall free from external defects.
7.2	Dimensional Check	The dimensional requirements shall be checked as per the drawing.

Technical Specification of Various Types Of Structural Steel Items

7.3	Acceptance Test	Following tests needs to be conducted by the vendor during inspection (value shall be followed as per relevant IS/IEC) a) Tensile Strength b) Yield Stress c) Elongation d) Chemical Composition as per IS 2062 from NABL accredited LAB. e) Incase of unavailability of inhouse testing facility, tests shall be conducted from NABL accredited LAB.
-----	-----------------	--

8.0 MARKING

8.1	The material shall be embossed with the details mentioned	a) Name/Model of the material b) Identification of the source of manufacture c) ISI mark
-----	---	--

9.0 DEVIATION

Deviations from this Specification shall be stated in writing with the tender by reference to the Specification clause/GTP/Drawing and a description of the alternative offer. In absence of such a statement, requirements of the Specification shall be met without exception.

10.0 GUARANTEE CERTIFICATE

Guarantee Certificate to be given for any manufacturing defects along with its consignment from the date of receipts at stores for free replacement within one year.

11.0 DOCUMENTS SUBMISSION

Document submission shall be as per the matrix given below. All documents/drawing shall be provided in soft copy for each section. Language of the documents shall be English only. Deficient/improper drawing submission may liable for rejection.

S.No.	Detail of Document	For Tender	For Approval/Review	Final Submission
11.1	Deviation Sheet, if any	Required	Required	Required
11.2	GA and Dimensional	Required	Required	Required



BSES-TS-17-SSI-R0

Technical Specification of Various Types Of Structural Steel Items

S.No.	Detail of Document	For Tender	For Approval/Review	Final Submission
	Drawing			
11.3	Manufacturer's quality assurance plan and certification for quality standards		Required	Required
11.4	Make of Raw Materials	Required	Required	Required
11.5	Inspection and test reports, carried out in manufacturer's works			Required
11.6	Routine Test Certificates			Required
11.7	Test certificates of all the raw materials			Required